

Features

1 - Phase 230 V
Over & Under voltage monitoring relays

71.11.8.230.0010

- Fixed Over & Under voltage detection
- Link selectable 5 or 10 minute lock-out delay

71.11.8.230.1010

- Adjustable Over & Under voltage detection
- Switch selectable 5 or 10 minute lock-out delay

- 35 mm rail (EN 60715) mounting
- LED indication
- Positive safety logic (healthy conditions - output relay energised)

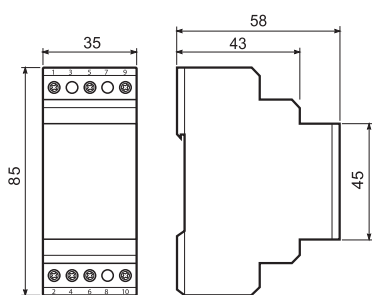

71.11.8.230.0010



- Fixed - Over/Under voltage limits, $(0.75...1.2) U_N$ respectivity
- Link selectable - 5 min or 10 min delay

71.11.8.230.1010



- Adjustable - symmetrical Over/Under voltage limits adjustable between $\pm 5\%$ to $\pm 20\%$ U_N
- Switch selectable - 5 min or 10 min delay

- Detects and trips on out-of-limits L-N voltage, and protects against excessive "starts/hour" through "power-on" and "lock-out" time delays.
- Typical applications - protection of compressor motors and high pressure discharge lamp circuitry.

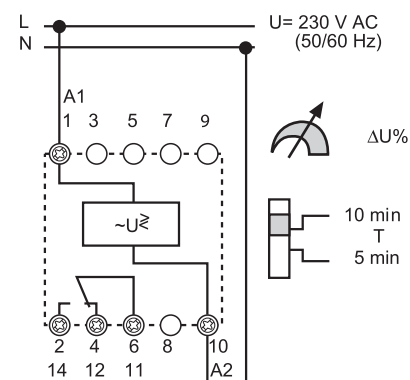
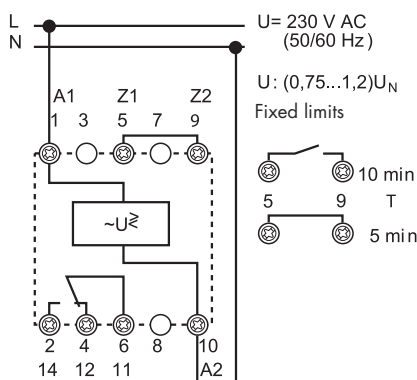

Contact specification

Contact configuration	1 CO (SPDT)	1 CO (SPDT)
Rated current/Maximum peak current A	10/15	10/15
Rated voltage/Maximum switching voltage V AC	250/400	250/400
Rated load AC1 VA	2,500	2,500
Rated load AC15 (230 V AC) VA	500	500
Single phase motor rating (230 V AC) kW	0.5	0.5
Breaking capacity DC1: 30/110/220 V A	10/0.3/0.12	10/0.3/0.12
Minimum switching load mW (V/mA)	300 (5/5)	300 (5/5)
Standard contact material	AgCdO	AgCdO

Supply specification

Nominal voltage (U_N)	V AC (50/60 Hz)	230	230
	V DC	—	—
Rated power AC/DC VA (50 Hz)/W		4/—	4/—
Operating range	AC	$(0.75...1.2)U_N$	$(0.8...1.2)U_N$
	DC	—	—

Technical data

Electrical life at rated load AC1 cycles		$100 \cdot 10^3$	$100 \cdot 10^3$
Detection levels		Fixed $(0.75...1.2)U_N$	Adjustable $(\pm 5... \pm 20)\% U_N$
Switch-on lock-out time/reaction time		$(5 \text{ or } 10)\text{min} / < 0.5 \text{ s}$	$(5 \text{ or } 10)\text{min} / < 0.5 \text{ s}$
Fault memory		—	—
Electrical isolation: Supply to Measuring circuits		None – circuits are electrically common	None – circuits are electrically common
Ambient temperature range °C		$-20...+55$	$-20...+55$
Protection category		IP 20	IP 20

Approvals (according to type)



Features

3 - Phase 400 V

Over & Under voltage monitoring relay

71.31.8.400.1010

- Adjustable Over & Under voltage detection
- Switch selectable 5 or 10 minute lock-out delay

- 35 mm rail (EN 60715) mounting
- LED indication
- Positive safety logic (healthy conditions - output relay energised)

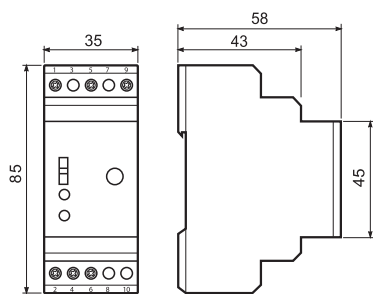

71.31.8.400.1010



- Adjustable - symmetrical Over/Under voltage limits adjustable between $\pm 5\%$ to $\pm 20\%$ U_N
- Switch selectable - 5 min or 10 min delay

- Detects and trips on out-of-limits L-L voltage, and protects against excessive "starts/hour" through "power-on" and "lock-out" time delays.
- Typical applications - protection of compressor motors and high pressure discharge lamp circuitry.

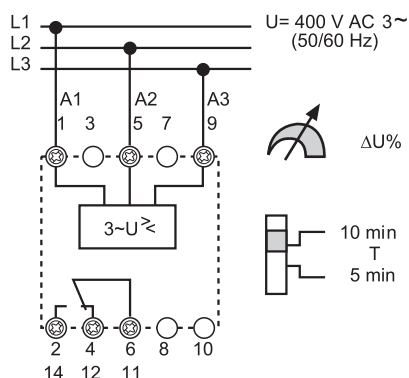

Contact specification

Contact configuration		1 CO (SPDT)
Rated current/Maximum peak current	A	10/15
Rated voltage/Maximum switching voltage	V AC	250/400
Rated load AC1	VA	2,500
Rated load AC15 (230 V AC)	VA	500
Single phase motor rating (230 V AC)	kW	0.5
Breaking capacity DC1: 30/110/220 V	A	10/0.3/0.12
Minimum switching load	mW (V/mA)	300 (5/5)
Standard contact material		AgCdO

Supply specification

Nominal voltage (U_N)	V AC (50/60 Hz)	400
	V DC	—
Rated power AC/DC	VA (50 Hz)/W	4/—
Operating range	AC	$(0.8 \dots 1.2) U_N$
	DC	—

Technical data

Electrical life at rated load AC1	cycles	$100 \cdot 10^3$
Detection levels	V (50/60 Hz)	Adjustable ($\pm 5 \dots \pm 20$)% U_N
Switch-on lock-out time/reaction time		(5 or 10)min / < 0.5 s
Fault memory		—
Electrical isolation: Supply to Measuring circuits		None – circuits are electrically common
Ambient temperature range	$^{\circ}\text{C}$	$-20 \dots +55$
Protection category		IP 20

Approvals (according to type)



Features

3 - Phase 400 V - Line monitoring relays

71.31.8.400.1021

- Over & Under voltage trip on-delay
- Fault memory

71.31.8.400.2000

- Phase asymmetry
- Phase rotation
- Phase loss

- 35 mm rail (EN 60715) mounting
- LED indication
- Positive safety logic (healthy conditions - output relay energised)

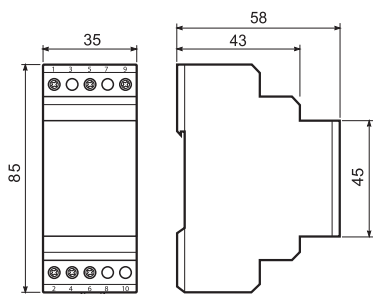

71.31.8.400.1021



- 3 phase 400 V - line voltage monitoring
- Detects over and under voltage
- Adjustable trip on-delay
- Switch selectable fault memory

71.31.8.400.2000



- 3 phase asymmetry monitoring
- Phase rotation monitoring
- Phase loss monitoring

- Under voltage trip level $(0.8...0.95)U_N$ - Adjustable
- Over voltage trip level $1.15 U_N$ - Fixed
- Trip delay time $(0.1...12)s$ adjustable
- Fault memory, switch selectable
- Fault acknowledgement by switch manipulation from ON to OFF and back to ON or power down

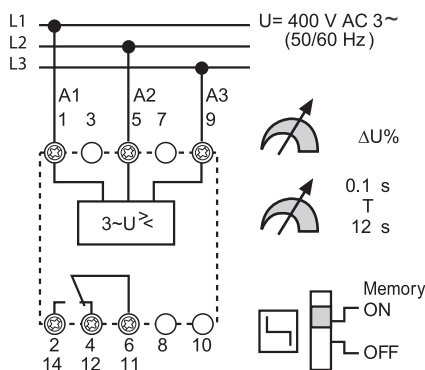

- Asymmetry between phases $(-5... -20)\% U_N$ adjustable
- Detection of the supply voltage U to A1 (1) and/or A2 (5) $> 1.11 U_N$

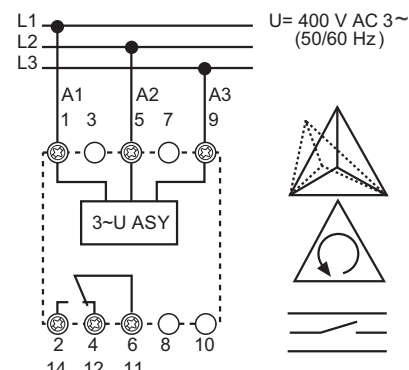

Contact specification			
Contact configuration		1 CO (SPDT)	1 CO (SPDT)
Rated current/Maximum peak current	A	10/15	10/15
Rated voltage/Maximum switching voltage V AC		250/400	250/400
Rated load AC1	VA	2,500	2,500
Rated load AC15 (230 V AC)	VA	500	500
Single phase motor rating (230 V AC)	kW	0.5	0.5
Breaking capacity DC1: 30/110/220 V	A	10/0.3/0.12	10/0.3/0.12
Minimum switching load	mW (V/mA)	300 (5/5)	300 (5/5)
Standard contact material		AgCdO	AgCdO
Supply specification			
Nominal voltage (U_N)	V AC (50/60 Hz)	400	400
	V DC	—	—
Rated power AC/DC	VA (50 Hz)/W	4/ —	4/ —
Operating range	AC	$(0.8...1.15)U_N$	$(0.8...1.15)U_N$
	DC	—	—
Technical data			
Electrical life at rated load AC1	cycles	$100 \cdot 10^3$	$100 \cdot 10^3$
Detection level	$U_{min}/U_{max}/Asymmetry$	$(0.8...0.95)U_N / 1.15 U_N / -$	$0.8 U_N / 1.11 U_N / [-5...-20]\% U_N$
Trip on-delay/reaction time		$(0.1...12)s / < 0.5 s$	— / $< 0.5 s$
Fault memory - selectable		Yes	—
Electrical isolation: Supply to Measuring circuits		None – circuits are electrically common	None – circuits are electrically common
Ambient temperature range	°C	-20...+55	-20...+55
Protection category		IP 20	IP 20
Approvals (according to type)			

Features

Universal voltage or current detecting and monitoring relay

71.41.8.230.1021 - Voltage monitoring

71.51.8.230.1021 - Current monitoring

- Zero voltage memory according to EN 60204-7-5
- Programmable for DC or AC detection level:
 - range detecting: upper and lower value
 - upper set point minus hysteresis range (5...50)% for switch on
 - lower set point plus hysteresis range (5...50)% for switch on
- Fault memory
- Electrical isolation between measuring and supply circuits
- Immune to supply interruptions of < 200 ms
- Wide detecting range:
 - voltage: DC (15...700)V, AC (15...480)V
 - 35 mm rail (EN 60715) mounting

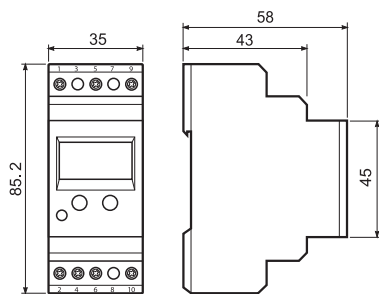

71.41.8.230.1021



- Programmable universal voltage monitoring relay

- AC/DC voltage detection - adjustable
- AC (50/60 Hz) (15...480)V
- DC (15...700)V
- Switch-on hysteresis (5...50)%
- Switch-off delay (0.1...12)s

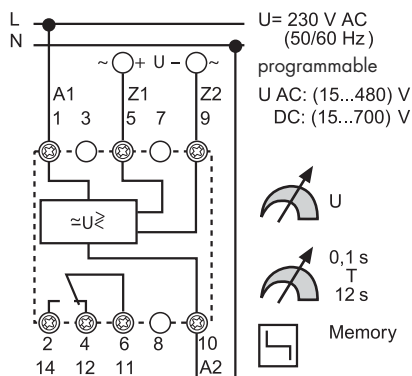

71.51.8.230.1021



- Programmable universal current monitoring relay
- Usable with current transformer 50/5, 100/5, 150/5, 250/5, 300/5, 400/5 or 600/5

- AC/DC current detection - adjustable
- AC(50/60Hz) (0.1...10)A with current transformer to 600A
- DC (0.1...10)A
- Switch-on hysteresis (5...50)%
- Switch-off delay (0.1...12)s
- Start delay (0.1...20)s

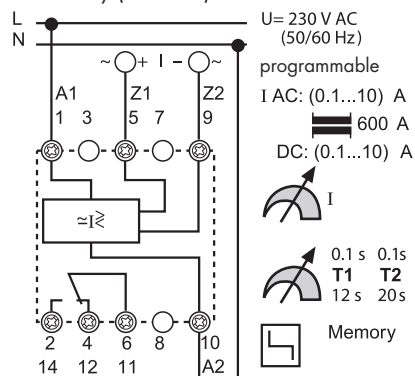

Contact specification

Contact configuration		1 CO (SPDT)	1 CO (SPDT)
Rated current/Maximum peak current	A	10/15	10/15
Rated voltage/Maximum switching voltage V AC		250/400	250/400
Rated load AC1	VA	2,500	2,500
Rated load AC15 (230 V AC)	VA	500	500
Single phase motor rating (230 V AC)	kW	0.5	0.5
Breaking capacity DC1: 30/110/220 V	A	10/0.3/0.12	10/0.3/0.12
Minimum switching load	mW (V/mA)	300 (5/5)	300 (5/5)
Standard contact material		AgCdO	AgCdO

Supply specification

Nominal voltage (U_N)	V AC (50/60 Hz)	230	230
	V DC	—	—
Rated power AC/DC	VA (50 Hz)/W	4 / —	4 / —
Operating range	AC	$(0.85...1.15)U_N$	$(0.85...1.15)U_N$
	DC	—	—

Technical data

Electrical life at rated load AC1	cycles	$100 \cdot 10^3$	$100 \cdot 10^3$
Detection levels	AC(50/60 Hz)/DC	(15...480)V/(15...700)V	(0.1...10)A at transducer to 600A / (0.1...10)A
Switch-off/reaction/Start delay		(0.1...12)s / < 0.35 s / < 0.5 s	(0.1...12)s / < 0.35 s / (0.1...20)s
Switch-on level of the detecting level	%	5...50	5...50
Fault memory - programmable		Yes	Yes
Electrical isolation: Supply to Measuring circuits		Yes	Yes
Ambient temperature range	°C	-20...+55	-20...+55
Protection category		IP 20	IP 20

Approvals (according to type)



Features

Thermistor temperature sensing relays for industrial applications

71.91 - 1 Pole, without fault memory

71.92 - 2 Pole, with fault memory

- Overload protection according EN 60204-7-3
- Positive safety logic - make contact opens if the measured value is outside of the acceptable range
- Industry standard module
- LED status indication
- 35 mm rail (EN 60715) mounting

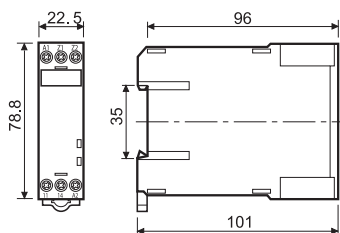

71.91

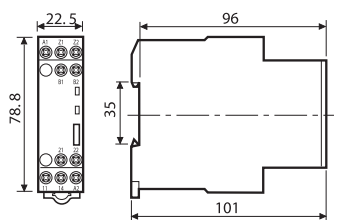

71.92

71.91.x.xxx.0300



- Thermistor relay
- 1 Pole normally open contact
- 24 V AC/DC, or 230 V AC supply

- Temperature detection with PTC
- PTC short circuit detection
- PTC wire breakage detection

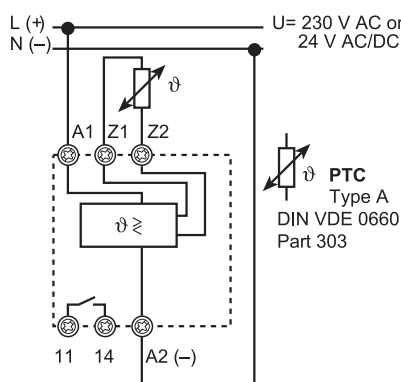

71.92.x.xxx.0001



- Thermistor relay with fault memory
- 2 Pole changeover contacts
- 24 V AC/DC, or 230 V AC supply

- Temperature detection with PTC
- Fault memory – switch selectable
- Reset by Reset button or supply interruption
- PTC short circuit detection
- PTC wire breakage detection

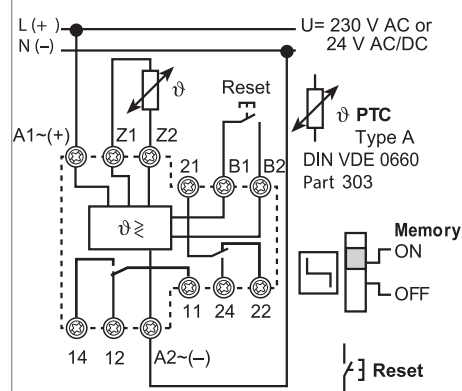

Contact specification

Contact configuration	1 NO (SPST-NO)	2 CO (DPDT)
Rated current/Maximum peak current A	10/15	10/15
Rated voltage/Maximum switching voltage V AC	250/400	250/400
Rated load AC1 VA	2,500	2,500
Rated load AC15 (230 V AC) VA	500	500
Single phase motor rating (230 V AC) kW	0.5	0.5
Breaking capacity DC1: 30/110/220 V A	10/0.3/0.12	10/0.3/0.12
Minimum switching load mW (V/mA)	300 (5/5)	300 (5/5)
Standard contact material	AgCdO	AgCdO

Supply specification

Nominal voltage (U _N)	V AC (50/60 Hz)	230	230
	V AC/DC	24	24
Rated power AC/DC VA (50 Hz)/W		1/0.5	1/0.5
Operating range	AC	(0.85...1.15)U _N	(0.85...1.15)U _N
	DC	—	—

Technical data

Electrical life at rated load AC1 cycles	100 · 10 ³	100 · 10 ³
PTC detecting: Short circuit/Temperature OK	<20 Ω / >20 Ω ... <3 kΩ	<20 Ω / >20 Ω ... <3 kΩ
	Reset/PTC break	<1.3 kΩ / >3 kΩ
Delay time/activation time	— / < 0.5 s	— / < 0.5 s
Fault memory - switch selectable	—	Yes
Electrical isolation: Supply to Measuring circuits	Yes	Yes
Ambient temperature range °C	-20...+55	-20...+55
Protection category	IP 20	IP 20

Approvals (according to type)



Ordering information

Example: Universal voltage monitoring relay with LCD display for AC/DC voltage detection, 1 CO (SPDT) contact rated 10 A 250, supply voltage 230 V, programmable delay time and fault memory.

7 1 . 4 1 . 8 . 2 3 0 . 1 0 2 1

Series

Type

- 1 = 1 phase AC line monitoring
- 3 = 3 phase AC line monitoring
- 4 = AC/DC universal- Voltage detection
- 5 = AC/DC universal- Current detection
- 9 = Thermistor relay (temperature monitoring with PTC thermistor)

No. of poles

- 1 = 1 CO (SPDT) types 71.11, 31, 41, 51
- 1 = 1 NO (SPST-NO) type 71.91
- 2 = 2 CO (DPDT) type 71.92

Supply version

- 0 = AC(50/60Hz)/DC
- 8 = AC (50/60 Hz)

Supply voltage

- 024 = 24 V AC/DC
- 230 = 230 V
- 400 = 400 V

Additional functions

- 0 = Basic function
- 1 = Adjustable detection value
- 2 = Adjustable: Asymmetry, phase loss, phase rotation

Special versions

- 0 = No fault memory
- 1 = Fault memory

Options

- 0 = No delay time
- 1 = Two selectable delay times
- 2 = Adjustable delay times

Contact circuit

- 0 = CO (nPDT)
- 3 = NO (nPST-NO)

Technical data

Insulation			
Insulation according to EN 61810-1		insulation rated voltage	V 250
		rated impulse withstand voltage	kV 4
		pollution degree	3
		over-voltage category	III
Dielectric strength (A1, A2, A3, B1, B2), and contact terminals (11, 12, 14) and terminals (Z1, Z2)		V AC	2,500
		kV (1.2/50 µs)	6
Dielectric strength at open contact		V AC	1,000
EMC specifications			
Type of test		Reference Standard	
Electrostatic discharge	contact discharge	EN 610004-2	8 kV
	air discharge	EN 610004-2	8 kV
Radio-frequency electromagnetic field (80...1,000)MHz		EN 610004-3	3 V/m
Fast transients (burst) (5-50 ns, 5 kHz) on (A1, A2, A3, B1, B2) and (Z1, Z2)		EN 610004-4	2 kV
Surges (1.2/50 µs) on (A1, A2, A3, B1, B2) and (Z1, Z2)	common mode	EN 610004-5	4 kV
	differential mode	EN 610004-5	4 kV
Radio-frequency common mode (0.15 ÷ 80 MHz) to A1 - A2		EN 610004-6	10 V
Radiated and conducted emission		EN 55022	class B
Other data			
Voltage and current values at terminals Z1 Z2	Type 71.11	Link for time range	V / mA 230 V / —
	Type 71.91, 71.92	PTC temperature measurement	V / mA 24 V / 2.4
Maximum length of wiring to the Supply terminals/ Measuring terminals	Type 71.11, 71.31	Contact bridge for time range	m 150 / —
	Type 71.41	Voltage measurement	m 150 / 50
	Type 71.51	Current measurement	m 150 / 50
(Wiring capacitance no greater than 10 nF/100 m)	Type 71.91, 71.92	PTC temperature measurement	m 50 / 50
Measuring principle	Type 71.11, 71.31, 71.41, 71.51, 71.91, 71.92	The measured value is the arithmetical average of 500 individual measurements taken over a 100 ms period. Interruptions less than <200 ms are ignored.	
Safety logic	Type 71.11, 71.31, 71.41, 71.51, 71.91, 71.92	Positive safety logic - When the value being monitored lies within the acceptable area, the make contact is closed.	
Reaction time (following the application of the supply voltage)	Type 71.11, 71.31, 71.41, 71.51, 71.91, 71.92	≤ 0.5 s	
Power lost to the environment	without contact load	W 4	
	with rated current	W 5	
Permitted storage temperature range	°C	-40...+85	
Protection category		IP 20	
 Screw torque	Nm	0.8	
Max. wire size		solid cable	standed cable
	mm ²	0.5...(2 x 2.5)	(2 x 1.5)
	AWG	20...(2 x 14)	(2 x 16)

Functions



















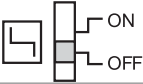





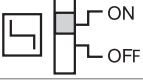



































Monitoring relay	Types										Times			Supply voltage		Module width		Contact conf.			
	1-phase 230 V, Under/Overvoltage	3-phase 400 V, Under/Overvoltage	3-phase 400 V, Phase/Symmetry	3-phase 400 V, Phase loss	3-phase 400 V, Phase	DC voltage (15...700)V Under and Over voltage monitoring	AC voltage (15...484)V Under and Over voltage monitoring	DC current (0.1...10)A Under and Over current monitoring	AC current (0.1...10)A (for to 600 A with current transformers) Under and Over current monitoring	Thermistor relay (PTC)	Adjustable	Fault memory for 71.41 and 71.51	Delay time 5/10 min	Delay time (0.1...12)s adjustable	Power-up activation time delay (0.1...20)s — starting inrush current suppression	24 V AC/DC	230 V AC		400 V AC	35 mm wide	22.5 mm wide
71.11.8.230.0010	•											•				•					1 CO SPDT
71.11.8.230.1010	•									•		•				•					1 CO SPDT
71.31.8.400.1010		•								•		•					•				1 CO SPDT
71.31.8.400.1021		•								•	•		•				•				1 CO SPDT
71.31.8.400.2000			•	•	•					•							•				1 CO SPDT
71.41.8.230.1021	•					•	•			•	•		•			•					1 CO SPDT
71.51.8.230.1021								•	•	•	•		•	•		•					1 CO SPDT
71.91.0.024.0300									•	•						•				•	1 NO SPST-NO
71.91.8.230.0300									•	•						•				•	1 NO SPST-NO
71.92.0.024.0001									•	•	•					•				•	2 CO DPDT
71.92.8.230.0001									•	•	•					•				•	2 CO DPDT
Current transformer	Source as required																				

Explanation of relay marking and LED/LCD display

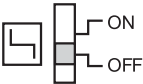
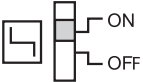
Monitoring relay without LCD-display	
ON	LED green steady light: supply voltage is on and measuring system is active.
DEF	Default: the detected value is outside of the acceptable range (asymmetric is shown by the LED ASY). LED red flashing: delay time is running, see the function diagram. LED red steady light: output relay is off, contact 11-14 (6-2) is open.
ASY	Phase asymmetry is outside of the predefined range. LED steady light: output relay is turned off, contact 11-14 (6-2) is open.
LEVEL	Selected range as % value.
TIME	Delay time min (minutes) or s (seconds).
MEMORY ON	Fault memory switched on: the state of the output relay after the occurrence of a fault –contact 11-14 (6-2) open– will be maintained, monitored value returns to within acceptable limits. Fault reset is made by switch manipulation from ON to OFF to ON, or by power down (71.31.8.400.1021 & 71.92.x.xxx.0001), or by operating of the “RESET” (71.92.x.xxx.0001).
MEMORY OFF	Fault memory turned off: the state of the output contacts will only remain in the “fault” condition –contact 11-14 (6-2) open– while the monitored value is outside of the acceptable limits. When the monitored value returns within the acceptable limits the contact will revert to the energised state. Monitored equipment will start again automatically.

Monitoring relay with LCD-display																
SET/RESET	Relay 71.41 and 71.51. Sets and resets the programmable values - see operating in the packing.															
SELECT	Relay 71.41 and 71.51. Selects the desired parameter for programming - see operating instructions.															
DEF	Default, LED red steady or flashing.															
PROG Modus	Enter the programming mode by simultaneously pressing the buttons “SET/RESET” and “SELECT” for 3 seconds. The word “prog” is shown for 1 second. “SELECT” allows the choice of “AC” or “DC”, and is confirmed with “SET/RESET”. Successively pressing the button “SELECT” brings up the choices of Up, or Up _{Lo} . The appropriate choice is made by pressing the “SET/RESET” button. The next step will program the appropriate values and the selection of the fault memory function (which is selected with a “YES” or “NO”). If all programming steps are completed the display will read “end”.															
Short programming instruction	After repeatedly pressing the “SET/RESET” button the measured value will be displayed, or “0” appears if nothing is connected to Z1 and Z2 (5 and 9). If the programming is broken off before “end” is shown in the display the previous program will remain unchanged after an interruption of the supply voltage.															
Program query	Pushing the “SELECT” button for at least 1 second, enters the “program inquiry mode”. The programmed mode and the values are shown on the repeated pressing of the “SELECT” button.															
Flashing M (memory)	Fault memory has had effect (fault acknowledgement and reset is made by a 1 second press of the “SET/RESET” button).															
LCD-display	<table border="0"> <tr> <td>V = volt</td> <td>Level= value</td> <td>$t_1 = T_1$ - time during which short-time fluctuations are not taken into account</td> </tr> <tr> <td>A = amp</td> <td>Hys = hysteresis</td> <td>$t_2 = T_2$ - (monitoring relay 71.51) the time during which inrush currents are not taken into account</td> </tr> <tr> <td>Up = upper limit (with hysteresis in down direction)</td> <td>M = memory (fault)</td> <td></td> </tr> <tr> <td>Lo = lower limit (with hysteresis in up direction)</td> <td>Yes = yes - with memory</td> <td></td> </tr> <tr> <td>Up_{Lo} = upper and lower limit - range detecting</td> <td>no = no - without memory</td> <td></td> </tr> </table>	V = volt	Level= value	$t_1 = T_1$ - time during which short-time fluctuations are not taken into account	A = amp	Hys = hysteresis	$t_2 = T_2$ - (monitoring relay 71.51) the time during which inrush currents are not taken into account	Up = upper limit (with hysteresis in down direction)	M = memory (fault)		Lo = lower limit (with hysteresis in up direction)	Yes = yes - with memory		Up _{Lo} = upper and lower limit - range detecting	no = no - without memory	
V = volt	Level= value	$t_1 = T_1$ - time during which short-time fluctuations are not taken into account														
A = amp	Hys = hysteresis	$t_2 = T_2$ - (monitoring relay 71.51) the time during which inrush currents are not taken into account														
Up = upper limit (with hysteresis in down direction)	M = memory (fault)															
Lo = lower limit (with hysteresis in up direction)	Yes = yes - with memory															
Up _{Lo} = upper and lower limit - range detecting	no = no - without memory															

LED/LCD status announcement/advice

Type	Starting mode	Normal operation	Abnormal mode		Reset
71.11.8.230.0010 71.11.8.230.1010 71.31.8.400.1010	 After connecting T = 5 or 10 min  11-14 open	 Normal operation Set point is OK  11-14 is closed	 Time T runs Set point is immaterial  11-14 is open Will close after T, if set point is OK	 After expiry of T Set point is not OK  11-14 is open Will close, if set point is OK	
71.31.8.400.1021 Memory OFF 		 Normal operation Set point is OK  11-14 is closed	 Time T runs, Set point is not OK  11-14 is closed	 After expiry of T Set point is not OK  11-14 is open Will close, if set point is OK	
71.31.8.400.1021 Memory ON 		 Normal operation Set point is OK  11-14 is closed	 Time T runs, Set point is not OK  11-14 is closed	 After expiry of T Set point is not OK  11-14 is open Will not close at RESET	 After expiry of T Set point is OK  11-14 is open Will close at RESET
71.31.8.400.2000		 Normal operation Set point is OK  11-14 is closed	 Supply voltage to A1(1) and / or  A2(5) is missing 11-14 is open, Will close if supply voltage restored and set point OK  Incorrect phase rotation or phase failure or voltage  A1(1) and/ot A2(5) is > 1.11 U _N 11-14 is open Will close, if set point is OK	 Phase asymmetry  11-14 is open  Will close, if set point is OK	
71.41.8.230.1021 Memory OFF		Measured value displayed  Normal operation Set point is OK 11-14 is closed	Measured value displayed  Time T runs, Set point is not OK 11-14 is closed	Measured value displayed  After expiry of T Set point is not OK 11-14 is open Will close, if set point is OK	
71.41.8.230.1021 Memory ON		Measured value displayed  Normal operation Set point is OK 11-14 is closed	Measured value displayed  Time T runs, Set point is not OK 11-14 is closed	M in the display flashes Measured value displayed  After expiry of T Set point is not OK 11-14 is open Will not close at RESET	M in the display - static Measured value displayed  After expiry of T Set point is OK 11-14 is open Will close at RESET
71.51.8.230.1021 Memory OFF	Measured value displayed  Time T2 runs, Set point immaterial 11-14 is closed	Measured value displayed  Normal operation Set point is OK 11-14 is closed	Measured value displayed  Time T runs, Set point is not OK 11-14 is closed	Measured value displayed  After expiry of T Set point is not OK 11-14 is open Will close, if set point is OK	
71.51.8.230.1021 Memory ON	Measured value displayed  Time T2 runs, Set point immaterial 11-14 is closed	Measured value displayed  Normal operation Set point is OK 11-14 is closed	Measured value displayed  Time T runs, Set point is not OK 11-14 is closed	M in the display flashes Measured value displayed  After expiry of T Set point is not OK 11-14 is open Will not close at RESET	M in the display - static Measured value displayed  After expiry of T Set point is OK 11-14 is open Will close at RESET
71.91.x.xxx.0300		 Normal operation Set point is OK  11-14 is closed	 Temperature to high or PTC line break or PTC short circuit 11-14 is open Will close, if set point is OK		
71.92.x.xxx.0001 Memory OFF		 Normal operation Set point is OK  11-14 is closed	 Temperature to high or PTC line break or PTC short circuit 11-14 is open Will close, if set point is OK		
71.92.x.xxx.0001 Memory ON  		 Normal operation Set point is OK  11-14 is closed	 Temperature to high or PTC line break or PTC short circuit 11-14 is open	 Temperature is OK 11-14 is open  Will close at RESET	

Functions

<p>Type 71.11.8.230.0010</p> <p>U= 230 V AC (50/60 Hz) U: (0,75...1,2)U_N Fixed limits</p>	<p>Switch off Immediately if monitored value is outside of the set points.</p> <p>Switch on After expiry of the time T and if monitored value is within the set points.</p> <p>C = output contact Normally open 11-14 (6-2) closed.</p>
<p>Type 71.11.8.230.1010</p> <p>U= 230 V AC (50/60 Hz)</p>	<p>Switch OFF Immediately if monitored value is outside of the set points.</p> <p>Switch on After expiry of the time T and if monitored value is within the set points.</p> <p>C = output contact Normally open 11-14 (6-2) closed, all values within the set points.</p>
<p>Type 71.31.8.400.1010</p> <p>U= 400 V AC 3~ (50/60 Hz)</p>	<p>Switch off Immediately if monitored value is outside of the set points.</p> <p>Switch on After expiry of the time T and if monitored value is within the set points.</p> <p>C = output contact Normally open 11-14 (6-2) closed.</p>
<p>Type 71.31.8.400.1021</p> <p>U= 400 V AC 3~ (50/60 Hz)</p>	<p>Switch off If monitored value is outside of the set points and time T has elapsed.</p> <p>Switch on - MEMORY OFF Immediately monitored value returns within limits (off-set by 1% hysteresis).</p> <p>Switch on - MEMORY ON As above, but subject to the RESET operation having been actioned.</p> <p>RESET By Memory switch manipulation from ON to OFF and back to ON, or power down.</p> <p>*RESET MEMORY = By power-down or switch manipulation from ON to OFF to ON</p> <p>C = output contact Normally open 11-14 (6-2) closed.</p>

Functions

Type 71.31.8.400.2000

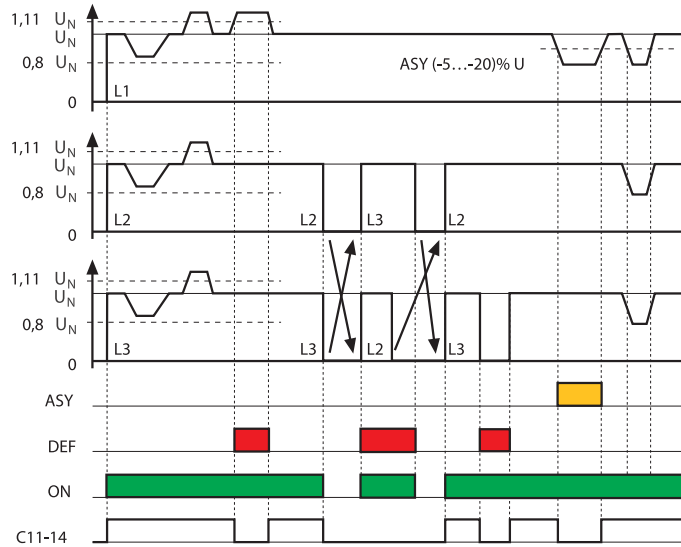
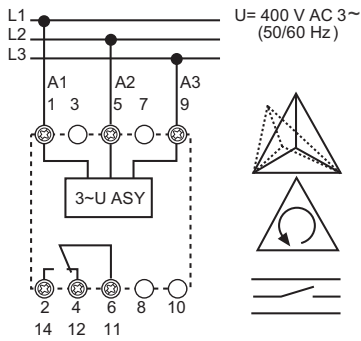

Switch off
Phase asymmetry
Incorrect phase rotation
Phase loss

LED • ASY yellow
Phase asymmetry

LED • DEF red
Voltage to A1 (1) and/or A2 (5) > 1.11 U_N

LED • ON green
Monitoring system is active and 400 V supply voltage is connected to 1-5 or A1-A2.

C = output contact
Normally open 11-14 (6-2) closed.

Type 71.41.8.230.1021

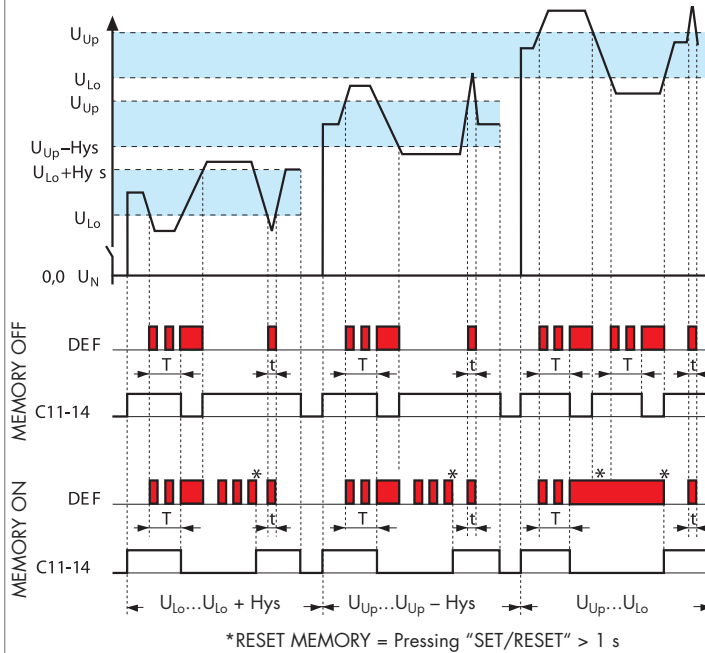
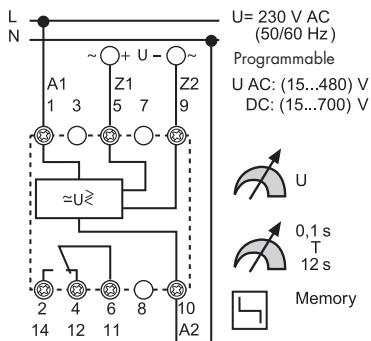

Switch off
 U_{Lo} - mode
If the monitored value is less than the lower-limit and, time T has expired.

U_{Up} - mode
If the monitored value is higher than the upper limit, and time T has expired.

U_{Lo} U_{Up} - mode
If the monitored value of voltage is outside of the upper or lower voltage limits, and time T has expired.

Voltage dips < T do not result in output relay switching off.

Switch on
 U_{Lo} or U_{Up} - modes
When passing the hysteresis value.

U_{Lo} U_{Up} - mode
When passing the U_{Lo} or U_{Up} value.

RESET MEMORY
Pressing "SET/RESET" > 1 sec.

C = output contact
Normally open 11-14 (6-2) closed.

*RESET MEMORY = Pressing "SET/RESET" > 1 s

Functions

Type 71.51.8.230.1021

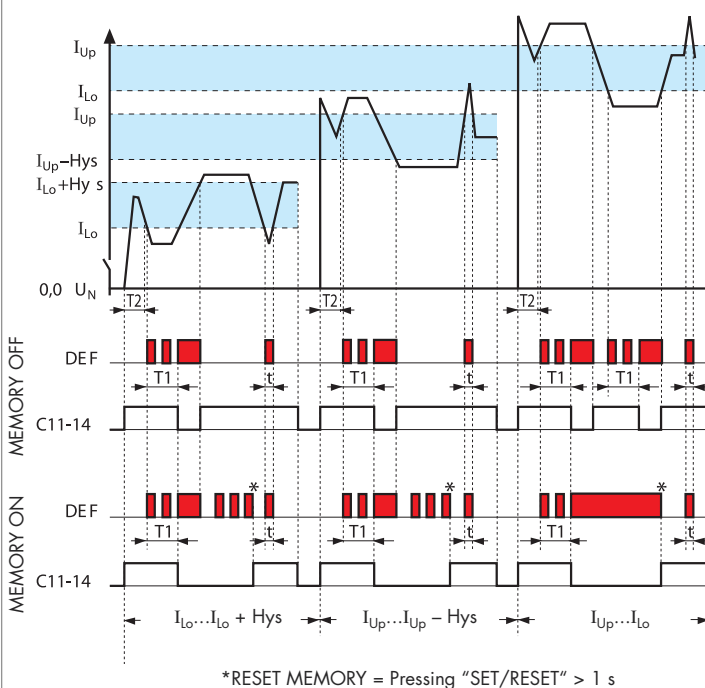
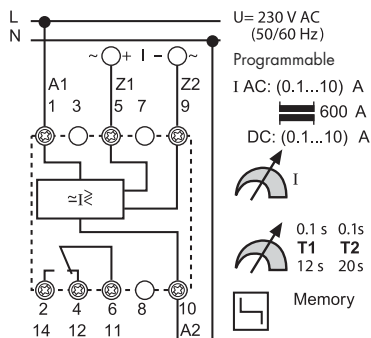

Switch off
 I_{Lo} - mode
 If the monitored value is less than the lower-limit and, time T_1 has expired.

I_{Up} - mode
 If the monitored value is higher than the upper limit, and time T_1 has expired.

I_{Lo} I_{Up} - mode
 If the monitored value of voltage is outside of the upper or lower limits, and time T_1 has expired.

Inrush current $< T_2$ is ignored

Current dips $< T_1$ do not result in output relay switching off.

*RESET MEMORY = Pressing "SET/RESET" > 1 s

Switch on
 I_{Lo} or I_{Up} - modes
 When passing the hysteresis value.

I_{Lo} I_{Up} - mode
 When passing the I_{Lo} or I_{Up} value.

RESET MEMORY
 Pushing "SET/RESET" > 1 sec.

C = output contact
 Normally open 11-14 (6-2) closed.

Type 71.91.x.xxx.0300

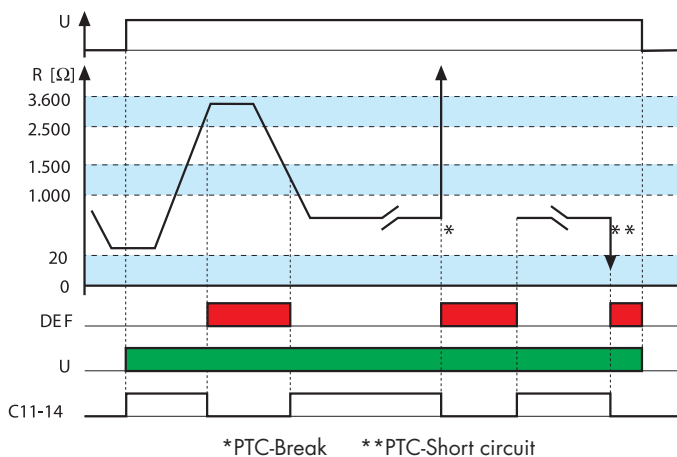
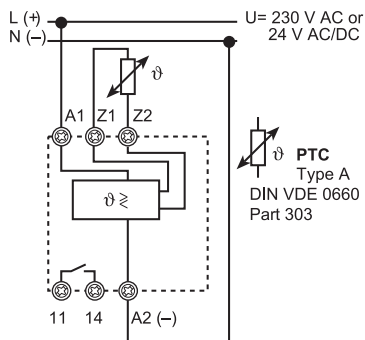

Switch off
 - Thermistor line break
 - Over temperature $R_{PTC} > (2.5...3.6)k\Omega$
 - Thermistor line short circuit ($R_{PTC} < 20\Omega$)
 - Loss of supply

Switch on
 Temperature within limits
 $R_{PTC} > (1.0...1.5)k\Omega$ on power-up.
 (1...1.5)kΩ on cooling.

C = output contact
 Normally open 11-14
 Closed when temperature within limits.

*PTC-Break **PTC-Short circuit

Functions

Type 71.92.x.xxx.0001

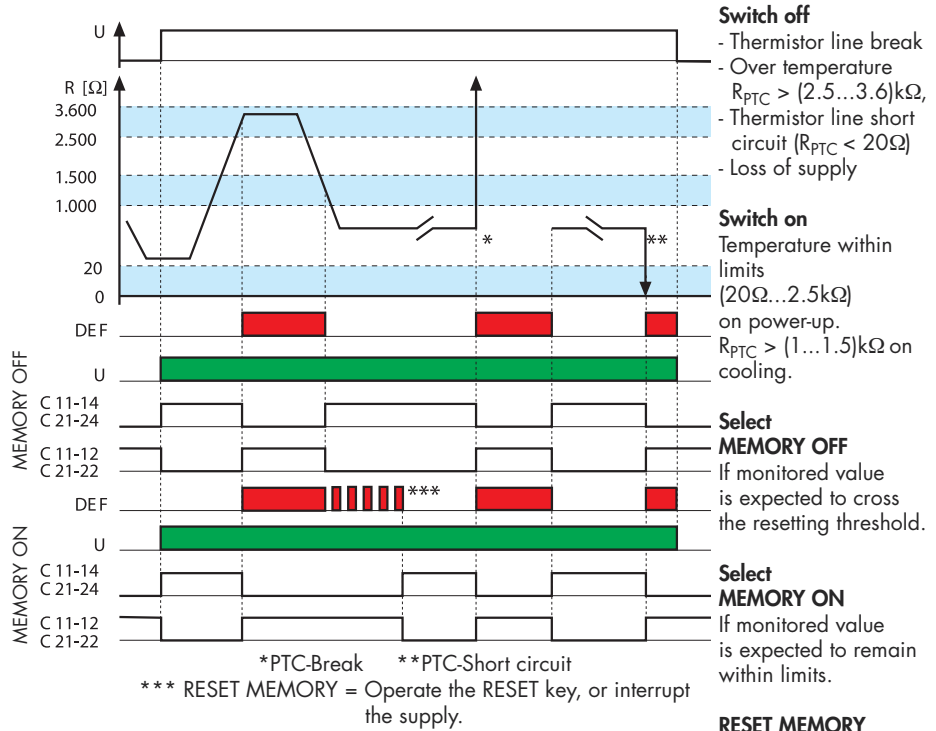
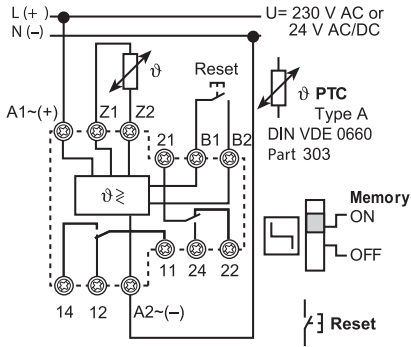

Switch off
 - Thermistor line break
 - Over temperature
 $R_{PTC} > (2.5 \dots 3.6)k\Omega$
 - Thermistor line short circuit ($R_{PTC} < 20\Omega$)
 - Loss of supply

Switch on
 Temperature within limits
 ($20\Omega \dots 2.5k\Omega$)
 on power-up.
 $R_{PTC} > (1 \dots 1.5)k\Omega$
 on cooling.

Select MEMORY OFF
 If monitored value is expected to cross the resetting threshold.

Select MEMORY ON
 If monitored value is expected to remain within limits.

RESET MEMORY
 Operate the RESET key, or interrupt the supply.

C = output contact
 Normally open 11-14 (21-24)
 Closed when temperature within limits.

Normally closed 11-22 (21-22)
 Closed when temperature outside limits / Power off.