

Main

Range of product	Harmony XAP
Product or component type	Die-cast empty control station
Device short name	XAPD
Product destination	For Ø 22 mm control and signalling units
Product front plate size	80 x 175 mm
Usable depth	49 mm
Number of cut-out	4 cut-outs
Colour of base of enclosure	Grey (RAL 7035)
Colour of cover	Grey (RAL 7035)
Material	Die cast zinc
Sale per indivisible quantity	1
IP degree of protection	IP65 conforming to EN/IEC 60529 and EN/IEC 60947-5-1

Complementary

Number of vertical rows	1
Number of horizontal rows	4
Cut-out dimensions	Ø 22 mm
Control station type	Metal
Cable entry	2 x cable gland conforming to ISO
Thread type	M25 x 1.5
CAD overall width	80 mm
CAD overall height	175 mm
CAD overall depth	51.5 mm
Net weight	0.87 kg

Environment

Protective treatment	TC
Ambient air temperature for storage	-40...70 °C
Ambient air temperature for operation	-25...70 °C
Electrical shock protection class	Class I conforming to EN/IEC 61140
IK degree of protection	IK07 conforming to EN/IEC 62262
Resistance to chemical agents	Special treatment can be obtained on request
Product certifications	EAC

Packing Units

Unit Type of Package 1	PCE
Number of Units in Package 1	1
Package 1 Weight	980.0 g
Package 1 Height	9.0 cm
Package 1 width	12.0 cm
Package 1 Length	18.5 cm

Unit Type of Package 2	S02
Number of Units in Package 2	6
Package 2 Weight	6.154 kg
Package 2 Height	15.0 cm
Package 2 width	30.0 cm
Package 2 Length	40.0 cm

Offer Sustainability

Sustainable offer status	Green Premium product
REACH Regulation	REACH Declaration
REACH free of SVHC	Yes
EU RoHS Directive	Pro-active compliance (Product out of EU RoHS legal scope) EU RoHS Declaration
Mercury free	Yes
RoHS exemption information	Yes
China RoHS Regulation	China RoHS Declaration
Environmental Disclosure	Product Environmental Profile
California proposition 65	WARNING: This product can expose you to chemicals including: Lead and lead compounds, which is known to the State of California to cause cancer and birth defects or other reproductive harm. For more information go to www.P65Warnings.ca.gov

Dimensions and Fixing

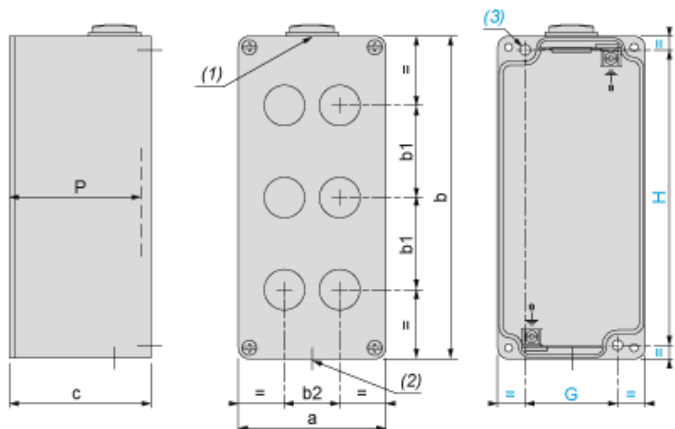

(1): 1 hole, with blanking plug (protrusion 6 mm/0.24 in.), for cable gland ISO M25 x 1.5

(2): 1 hole, without blanking plug, for cable gland ISO M25 x 1.5

(3): 2 x Ø 5.6 mm/0.22 in. holes, depth 19 mm/0.75 in.

P: Usable depth

a		b		c		G		H		P	
mm	in.	mm	in.	mm	in.	mm	in.	mm	in.	mm	in.
80	3.15	175	6.89	51.5	2.03	50	1.97	160	6.30	49	1.93

4 holes, Cut-out interaxis 22.5 mm ±0.20 mm / 0.885 in. ±0.0078 in. dimensions (vertical mounting)

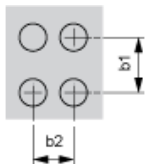

b1 Vertical interaxis: 30 mm/1.18 in.

b2 Horizontal interaxis: in center of the box