

XAPD14

Harmony XAP, XB2 SL, Empty control station, zinc alloy, grey, M20, undrilled, 80 x 80 x 77, UL cULus



Main

Range of product	Harmony XAP
Product or component type	Die-cast empty control station
Device short name	XAPD
Product destination	For Ø 22 mm control and signalling units
Product front plate size	80 x 80 mm
Usable depth	74.5 mm
Number of cut-out	Without cut-out
Colour of base of enclosure	Grey (RAL 7035)
Colour of cover	Grey (RAL 7035)
Material	Die cast zinc
Sale per indivisible quantity	1
IP degree of protection	IP65 conforming to EN/IEC 60529 and EN/IEC 60947-5-1 IP66 conforming to EN/IEC 60529 and EN/IEC 60947-5-1 IP69 conforming to EN/IEC 60529 and EN/IEC 60947-5-1

Complementary

Number of vertical rows	0
Number of horizontal rows	0
Control station type	Metal
Cable entry	2 x cable gland conforming to ISO
Thread type	M20 x 1.5
CAD overall width	80 mm
CAD overall height	80 mm
CAD overall depth	77 mm
Net weight	0.605 kg

Environment

Protective treatment	TC
Ambient air temperature for storage	-40...70 °C
Ambient air temperature for operation	-25...70 °C
Electrical shock protection class	Class I conforming to EN/IEC 61140
Degree of protection	UL type 4 conforming to UL 50 E UL type 4X conforming to UL 50 E
IK degree of protection	IK07 conforming to EN/IEC 62262
Resistance to chemical agents	Special treatment can be obtained on request
Product certifications	UL CULus EAC

The information provided in this documentation contains general descriptions and/or technical characteristics of the performance of the products contained herein. This documentation is not intended as a substitute for and is not to be used for determining suitability or reliability of these products for specific user applications. It is the duty of any such user or integrator to perform the appropriate and complete risk analysis, evaluation and testing of the products with respect to the relevant specific application or use thereof. Neither Schneider Electric Industries SAS nor any of its affiliates or subsidiaries shall be responsible or liable for misuse of the information contained herein.

Packing Units

Unit Type of Package 1	PCE
Number of Units in Package 1	1
Package 1 Weight	610.0 g
Package 1 Height	7.7 cm
Package 1 width	8.0 cm
Package 1 Length	8.0 cm
Unit Type of Package 2	S02
Number of Units in Package 2	12
Package 2 Weight	7.635 kg
Package 2 Height	15.0 cm
Package 2 width	30.0 cm
Package 2 Length	40.0 cm

Offer Sustainability

Sustainable offer status	Green Premium product
REACH Regulation	REACH Declaration
REACH free of SVHC	Yes
EU RoHS Directive	Pro-active compliance (Product out of EU RoHS legal scope) EU RoHS Declaration
Mercury free	Yes
RoHS exemption information	Yes
China RoHS Regulation	China RoHS Declaration
Environmental Disclosure	Product Environmental Profile
California proposition 65	WARNING: This product can expose you to chemicals including: Lead and lead compounds, which is known to the State of California to cause cancer and birth defects or other reproductive harm. For more information go to www.P65Warnings.ca.gov

Dimensions and Fixing

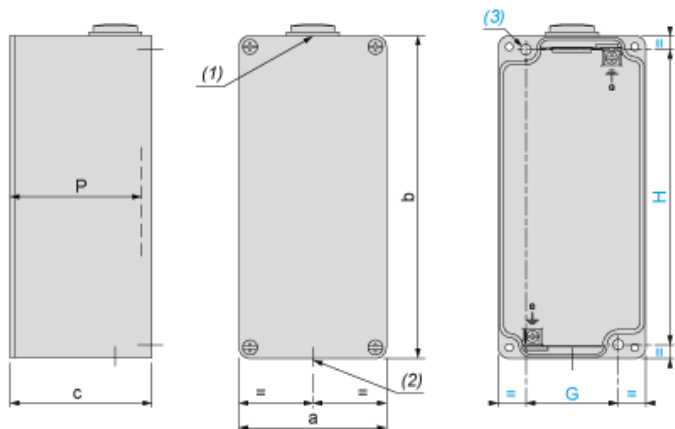

(1) : 1 hole, with blanking plug (protrusion 6 mm/0.24 in.), for cable gland ISO M20 x 1.5

(2) : 1 hole, without blanking plug, for cable gland ISO M20 x 1.5

(3) : 2 x Ø 5.6 mm/0.22 in. holes, depth 19 mm/0.75 in.

P : Usable depth

a		b		c		G		H		P	
mm	in.	mm	in.	mm	in.	mm	in.	mm	in.	mm	in.
80	3.15	80	3.15	77	3.03	50	1.97	65	2.56	74.5	2.93