



## Main

Range of product	OsiSense XS
Series name	General purpose
Sensor type	Inductive proximity sensor
Device application	-
Sensor name	XS1
Sensor design	Cylindrical Ø 4 mm plain
Size	29 mm
Body type	Fixed
Detector flush mounting acceptance	Flush mountable
Material	Metal
Type of output signal	Discrete
Wiring technique	3-wire
[Sn] nominal sensing distance	1 mm
Discrete output function	1 NO
Output circuit type	DC
Discrete output type	PNP
Electrical connection	Cable
Cable length	2 m
[Us] rated supply voltage	5...24 V DC
Switching capacity in mA	<= 100 mA with overload and short-circuit protection
IP degree of protection	IP67 conforming to IEC 60529

## Complementary

Detection face	Frontal
Front material	PPS
Enclosure material	Nickel plated brass
Operating zone	0...0.8 mm
Cable composition	3 x 0.11 mm <sup>2</sup>
Wire insulation material	PvR
Status LED	Output state: 1 LED (yellow)
Supply voltage limits	5...30 V DC
Switching frequency	<= 5000 Hz
Maximum voltage drop	<2 V (closed)
Current consumption	<= 10 mA no-load
Maximum delay first up	5 ms
Maximum delay response	1 ms
Maximum delay recovery	1 ms
Marking	CE
Threaded length	0 mm
Height	4 mm
Length	28 mm
Net weight	0.025 kg

## Environment

Product certifications	UL CSA
Ambient air temperature for operation	-25...70 °C
Ambient air temperature for storage	-40...85 °C
Vibration resistance	25 gn amplitude = +/- 2 mm (f = 10...55 Hz) conforming to IEC 60068-2-6
Shock resistance	50 gn for 11 ms conforming to IEC 60068-2-27

## Packing Units

Unit Type of Package 1	PCE
Unit Type of Package 2	BAG
Unit Type of Package 3	S02

## Offer Sustainability

Sustainable offer status	Green Premium product
EU RoHS Directive	Pro-active compliance (Product out of EU RoHS legal scope) <a href="#">EU RoHS Declaration</a>
Mercury free	Yes
RoHS exemption information	<a href="#">Yes</a>
Environmental Disclosure	<a href="#">Product Environmental Profile</a>
Circularity Profile	<a href="#">End Of Life Information</a>

## Contractual warranty

Warranty	18 months
----------	-----------

Dimensions

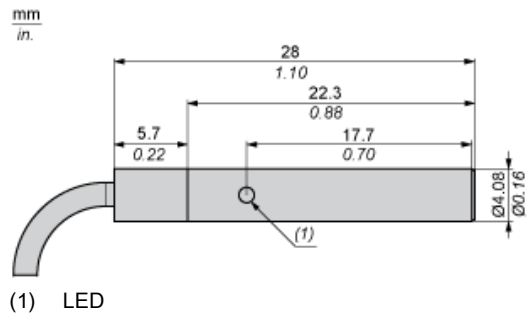

Minimum Mounting Distances in mm

Side by side



e (1) 2 mm/0.79 in.

≥

Face to face

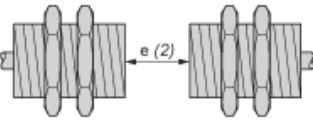

e (2) 12 mm/0.47 in.

≥

Facing a metal object

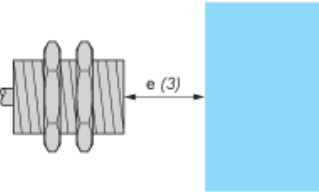

e (3) 3 mm/0.12 in.

≥

Mounted in a metal support

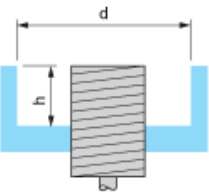

$d \geq 4 \text{ mm}/0.16 \text{ in.}$

$h \geq 0 \text{ mm}/0 \text{ in.}$

Tightening torque : 1.6 N.m. (values obtained with washers mounted)

Mounting

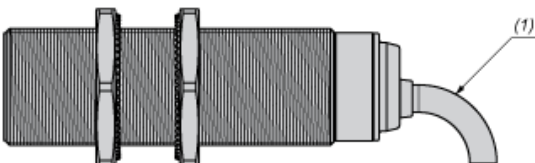

(1) Bending cable: 4 x external cable diameter

---

## Wiring Schemes

---

PNP

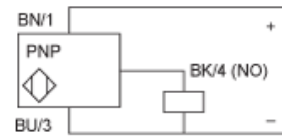

BU : Blue  
BN : Brown  
BK : Black

## Performance Curves

Standard Steel Target (mm) : 5x5x1

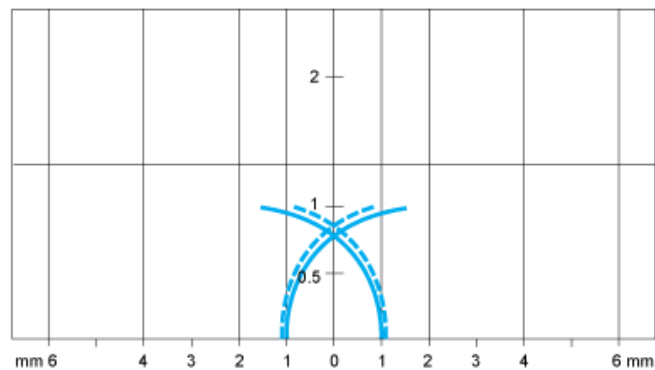

- Pick-up points
- - - Drop-out points (object approaching from the side)
- (y) Sensing distance in mm