



### Main

Range	TeSys
Product name	TeSys GV4
Device short name	GV4P
Circuit breaker functionalities	Circuit breaker
Device application	Motor
Protection type	Ground fault protection Short time short-circuit protection Short-circuit Overload Phase unbalance Phase loss
Suitability for isolation	Yes conforming to IEC 60947-1
Poles description	3P
[Ue] rated operational voltage	690 V AC 50/60 Hz conforming to IEC 60947-2
[In] rated current	115 A
Trip unit technology	Electronic Thermal-magnetic
Breaking capacity	35 kA at 208Y/120 V AC 50/60 Hz conforming to UL 60947 35 kA at 240 V AC 50/60 Hz conforming to UL 60947 18 kA at 480Y/277 V AC 50/60 Hz conforming to UL 60947 14 kA at 600Y/347 V AC 50/60 Hz conforming to UL 60947 Icu 10 kA at 500 V AC 50/60 Hz conforming to IEC 60947-2 Icu 20 kA at 440 V AC 50/60 Hz conforming to IEC 60947-2 Icu 25 kA at 380...415 V AC 50/60 Hz conforming to IEC 60947-2 Icu 50 kA at 220...240 V AC 50/60 Hz conforming to IEC 60947-2
[Ics] rated service breaking capacity	50 kA at 220...240 V AC 50/60 Hz conforming to IEC 60947-2 25 kA at 380...415 V AC 50/60 Hz conforming to IEC 60947-2 20 kA at 440 V AC 50/60 Hz conforming to IEC 60947-2 10 kA at 500 V AC 50/60 Hz conforming to IEC 60947-2
[Uimp] rated impulse withstand voltage	8 kV conforming to IEC 60947-2
[Ui] rated insulation voltage	800 V conforming to IEC 60947-2

Disclaimer: This documentation is not intended as a substitute for and is not to be used for determining suitability or reliability of these products for specific user applications

## Complementary

Mechanical durability	40000 cycles
Electrical durability	10000 cyclesFor AC-3 at 440 V In/2 5000 cyclesFor AC-3 at 440 V In
Motor power kW	110 kW at 660...690 V AC 50/60 Hz 37 kW at 400...415 V AC 50/60 Hz 45 kW at 400...415 V AC 50/60 Hz 45 kW at 500 V AC 50/60 Hz 55 kW at 400...415 V AC 50/60 Hz 55 kW at 500 V AC 50/60 Hz 75 kW at 500 V AC 50/60 Hz 75 kW at 660...690 V AC 50/60 Hz 90 kW at 660...690 V AC 50/60 Hz
Control type	Toggle
Number of slots	1 slot(s)For alarm switchFor fault signalling contact plug-in 1 slot(s)For voltage releaseFor electrical remote tripping plug-in 1 slot(s)For auxiliary switchFor open/close contact plug-in
Local signalling	Presence of auxiliary contacts: flag (green)
Quality labels	CE
Mounting mode	By clips By screws
Mounting support	35 mm symmetrical DIN rail 75 mm symmetrical DIN rail Plate
Connections - terminals	Top 1 EverLink BTR screw connectors wire size 1.5...70 mm <sup>2</sup> solid Top 1 EverLink BTR screw connectors wire size 1.5...50 mm <sup>2</sup> flexible Bottom 1 EverLink BTR screw connectors wire size 2.5...95 mm <sup>2</sup> solid Bottom 1 EverLink BTR screw connectors wire size 2.5...70 mm <sup>2</sup> flexible
Wire stripping length	20 mm
Tightening torque	9 N.mFor 16...95 mm <sup>2</sup> 5 N.mFor 1.5...10 mm <sup>2</sup>
Width	81 mm
Height	155 mm
Depth	116 mm
Product weight	1.45 kg
Colour	Grey (RAL 7016)

## Environment

Product certifications	IEC
Operating altitude	> 2000...5000 m with derating 2000 m without derating
IP degree of protection	IP40 front face conforming to IEC 60529
IK degree of protection	IK07 conforming to IEC 62262
Pollution degree	3 conforming to IEC 60947-1
Tropicalisation	2 conforming to IEC 68-2
Mechanical robustness	Vibrations: +/- 1 mm 2...13.2 Hz conforming to IEC 60068-2-6 Vibrations: 0.7 gn 13.2...100 Hz conforming to IEC 60068-2-6 Shocks: 15 gn 11 ms conforming to IEC 60068-2-27

## Offer Sustainability

Sustainable offer status	Green Premium product
RoHS (date code: YYWW)	Compliant - since 1736 - Schneider Electric declaration of conformity <a href="#">Schneider Electric declaration of conformity</a>
REACH	Reference not containing SVHC above the threshold <a href="#">Reference not containing SVHC above the threshold</a>
Product environmental profile	Available <a href="#">Product Environmental Profile</a>

---

Product end of life instructions

Available

 [End of Life Information](#)

---

Thermal-Magnetic Tripping Curves for GV4P, GV4PE, GV4PEM

Average Operating Times at 20 °C Related to Multiples of the Setting Current

Hot state

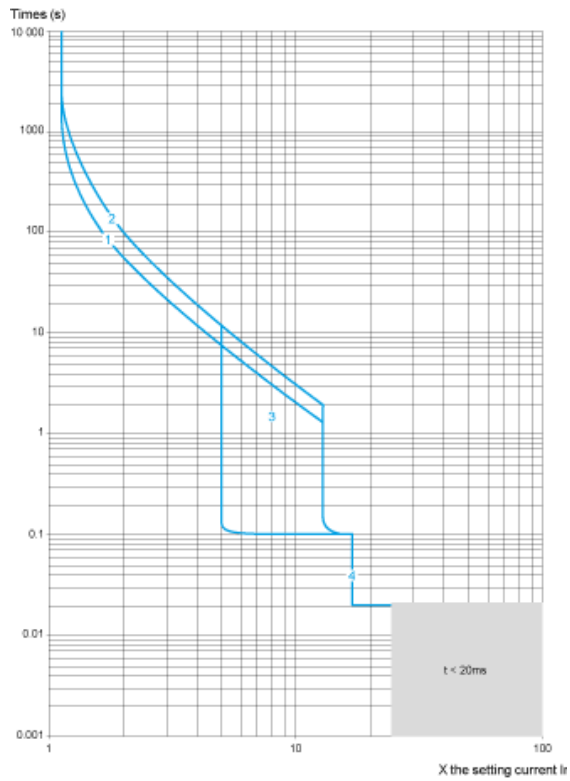

- 1 Class 10
- 2 Class 20
- 3  $I_{sd} = 5 \dots 13 \times I_r$
- 4  $I_i = 17 I_r$

## Cold state



- 1 Class 10
- 2 Class 20
- 3  $I_{sd} = 5 \dots 13 \times I_r$
- 4  $I_i = 17 I_n$

## Current Limitation on Short-Circuit for GV4P, GV4PE, GV4PEM (3-Phase 400/415 V)

Dynamic Stress

$I_{\text{peak}} = f(\text{prospective } I_{sc})$  at  $1.05 U_e = 435 \text{ V}$

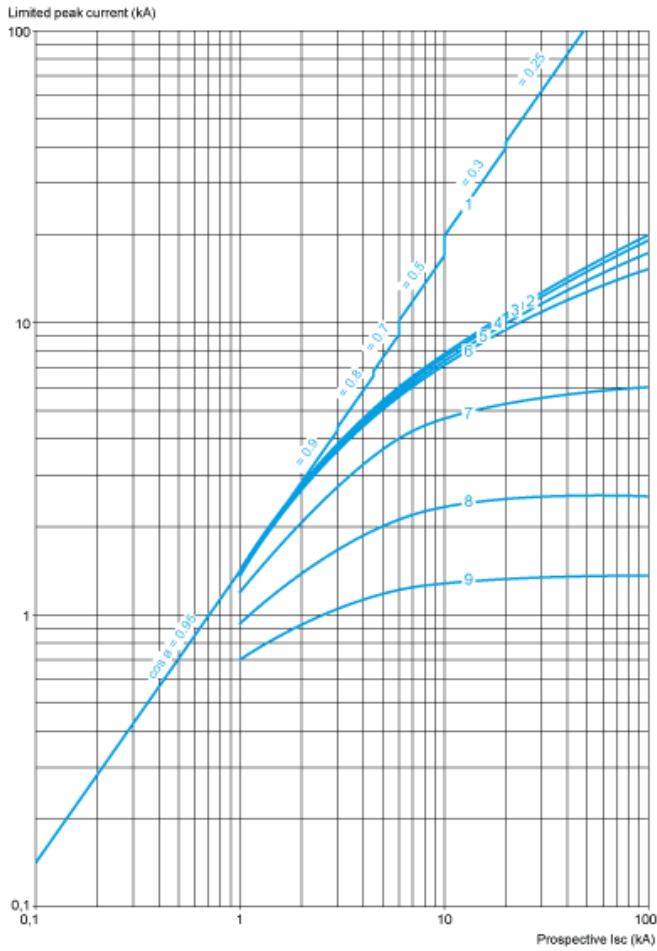

- 1 Maximum peak current
- 2 GV4P115
- 3 GV4P80
- 4 GV4P50
- 5 GV4P25
- 6 GV4P12
- 7 GV4P07
- 8 GV4P03
- 9 GV4P02

### Thermal Limit on Short-Circuit for GV4P, GV4PE, GV4PEM

Thermal Limit in  $kA^2s$  in the Magnetic Operating Zone

Sum of  $I^2dt = f$  (prospective Isc) at  $1.05 U_e = 435 V$

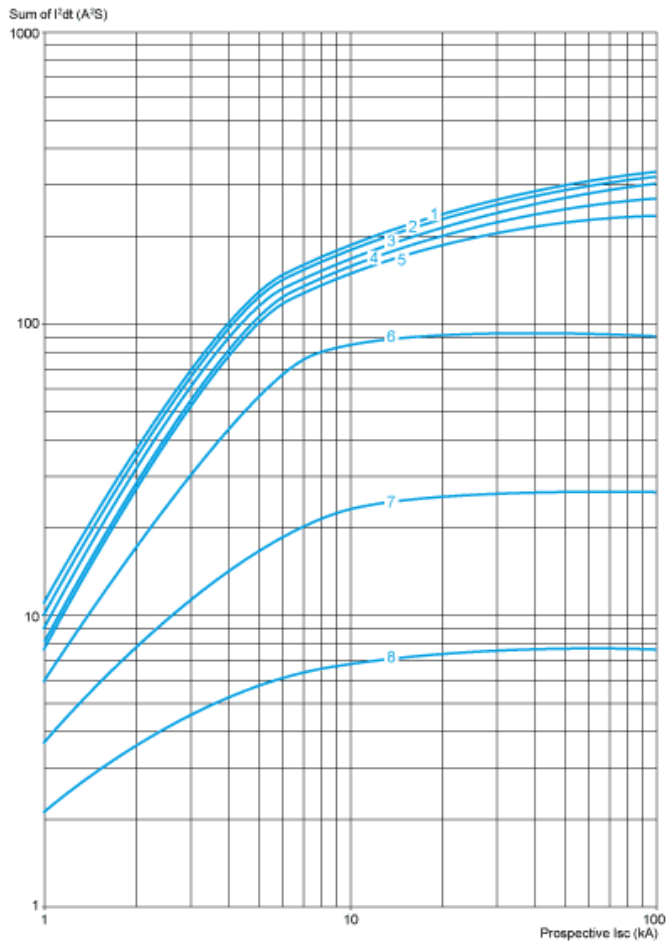

- 1 GV4P115
- 2 GV4P80
- 3 GV4P50
- 4 GV4P25
- 5 GV4P12
- 6 GV4P07
- 7 GV4P03
- 8 GV4P02

GV4 with Toggle: GV4LE, GV4PE, GV4PEM

With EverLink® Connector

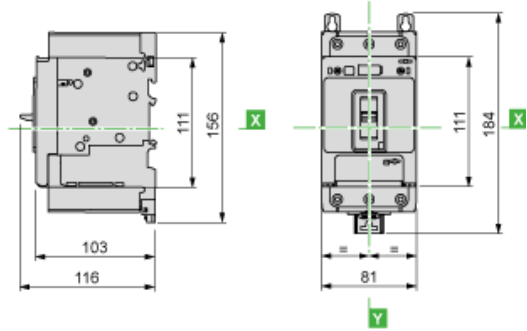

With Crimp Lug Connector

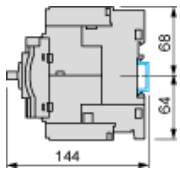

GV4 with Rotary Handle: GV4L, GV4P, or GV4LE, GV4PE, GV4PEM with GV4ADN01, GV4ADN02 Direct Mounting Rotary Handle

Dimensions

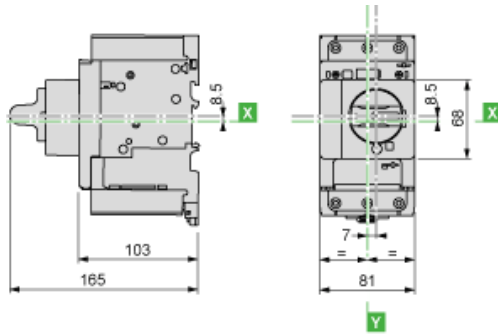

GV4L, GV4P, GV4LE, GV4PE, GV4PEM

Panel Mounting with M4 Screws

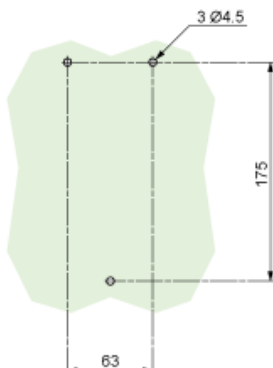

Door Cut-Out for Rotary Handle





Minimum Safety Clearance

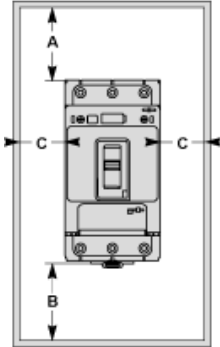

Toggle-type, rotary handle-type: identical clearance values.

Safety Clearance (mm)						
	Painted Sheet Metal			Bare Sheet Metal		
	A	B	C	A	B	C
No accessory	30	0	0	40	0	5
Interphase barriers	0	0	0	0	0	5
Long terminal shield	0	0	0	0	0	5

Magnetic Motor Circuit Breakers

GV4P, GV4PE, GV4PEM

