

Data sheet | Item number: 221-412

COMPACT Splicing Connectors; 2-conductor connector; with operating levers; Max.ambient operating temp. 85 °C

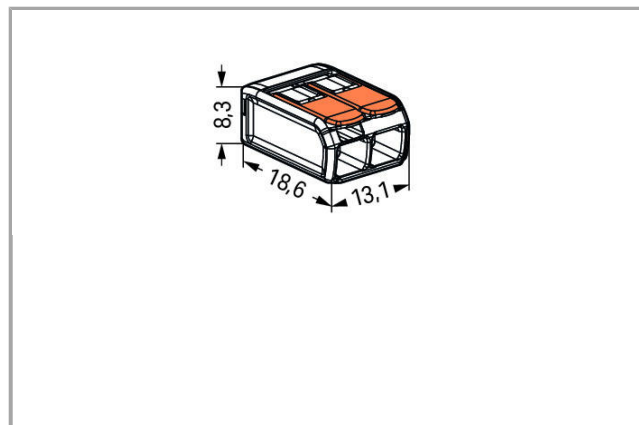

www.wago.com/221-412



Item description

Safety information 1:

In grounded power lines



Data

Electrical data

Ratings per IEC/EN 60664-1

Rated voltage (II / 2)	450 V
Rated impulse voltage (II / 2)	4 kV
Rated current	32 A

Connection data

Connection technology	CAGE CLAMP®
Actuation type	Lever
Connectable conductor materials	Copper
Nominal cross section	4 mm ²
Solid conductor	0.2 ... 4 mm ² / 24 ... 12 AWG
Stranded conductor	0.2 ... 4 mm ² / 24 ... 12 AWG
Fine-stranded conductor	0.14 ... 4 mm ² / 24 ... 12 AWG
Strip length	11 mm / 0.43 inch
Total number of connection points	2
Total number of potentials	1
Type of wiring	Side-entry wiring
Leiterquerschnitte eindrätig	0.2 mm ²

Geometrical Data

Width	13.1 mm / 0.516 inch
Height	8.3 mm / 0.327 inch
Depth	18.6 mm / 0.732 inch
Plug width	13.1 mm / 0.516 inch

Material Data

Color	transparent
Flammability class per UL94	V2
Fire load	0.033 MJ
Weight	1.6 g

Environmental Requirements



Surrounding air (operating) temperature	85 °C
Continuous operating temperature	105 °C
T-Marking per EN 60998	T85

Commercial data



Product Group	7 (Push Wire Conn.)
Country of origin	DE
GTIN	4050821808435
Customs Tariff No.	85369010000

Approvals / Certificates



Country specific Approvals

Logo	Approval	Additional Approval Text	Certificate name
	CCA DEKRA Certification B.V.	EN 60998	71-101731
	CCA DEKRA Certification B.V.	EN 60998	NTR NL-7642

Ship Approvals



Logo	Approval	Additional Approval Text	Certificate name
	ABS American Bureau of Shipping	-	18-HG1755093-PDA
	DNV GL Det Norske Veritas, Germanischer Lloyd	EN 60998	TAE000015T
	LR Lloyds Register	EN 60998	04/20013 (E6)

UL-Approvals

Logo	Approval	Additional Approval Text	Certificate name
	UL Underwriters Laboratories Inc.	UL 467	E201573
	UL Underwriters Laboratories Inc.	UL 486C	E69654

Compatible products

Mounting adapter

	Item no.: 221-500 Mounting carrier; 221 Series - 4 mm ² ; for DIN-35 rail mounting/screw mounting	www.wago.com/221-500
	Item no.: 221-502 Mounting carrier; for 2-conductor terminal blocks; 221 Series - 4 mm ² ; for screw mounting	www.wago.com/221-502
	Item no.: 221-502/000-004 Mounting carrier; for 2-conductor terminal blocks; 221 Series - 4 mm ² ; for screw mounting	www.wago.com/221-502/000-004
	Item no.: 221-512 Mounting carrier; for 2-conductor terminal blocks; 221 Series - 4 mm ² ; with snap-in mounting foot for horizontal mounting	www.wago.com/221-512
	Item no.: 221-512/000-004 Mounting carrier; for 2-conductor terminal blocks; 221 Series - 4 mm ² ; with snap-in mounting foot for horizontal mounting	www.wago.com/221-512/000-004
	Item no.: 221-522 Mounting carrier; for 2-conductor terminal blocks; 221 Series - 4 mm ² ; with snap-in mounting foot for vertical mounting	www.wago.com/221-522
	Item no.: 221-522/000-004 Mounting carrier; for 2-conductor terminal blocks; 221 Series - 4 mm ² ; with snap-in mounting foot for vertical mounting	www.wago.com/221-522/000-004
	Item no.: 222-505 Strain relief plate; for mounting carrier; 221 or 222 Series, can be snapped	www.wago.com/222-505
	Item no.: 222-510 Angled DIN-rail adapter; in combination with mounting carrier; 221-500 or 222-500; for DIN-35 rail mounting	www.wago.com/222-510

Downloads

CAD/CAE - Smart Data

CAD data

3D Download 221-412	URL	Download

Subject to changes.