



Main

| | |
|-------------------------------|------------------------------|
| Commercial Status | Commercialised |
| Range of product | Harmony XB4 |
| Product or component type | Head for key selector switch |
| Device short name | ZB4 |
| Bezel material | Chromium plated metal |
| Mounting diameter | 22 mm |
| Sale per indivisible quantity | 1 |
| Shape of signaling unit head | Round |
| Type of operator | Stay put |
| Operator profile | Black key switch |
| Operator position information | 2 positions 90° |
| Type of keylock | Ronis 458A |
| Key withdrawal position | Left |

Complementary

| | |
|------------------------------------|--|
| CAD overall width | 29 mm |
| CAD overall height | 29 mm |
| CAD overall depth | 72 mm |
| Product weight | 0.098 kg |
| Resistance to high pressure washer | 7000000 Pa at 55 °C, distance: 0.1 m |
| Mechanical durability | 1000000 cycles |
| Electrical composition code | C15 for 1 contacts using single blocks in front mounting C11 for <= 3 contacts using single blocks in front mounting C8 for <= 4 contacts using single and double blocks in front mounting C7 for <= 4 contacts using single blocks in front mounting C6 for <= 5 contacts using single and double blocks in front mounting C5 for <= 5 contacts using single blocks in front mounting C4 for <= 6 contacts using single and double blocks in front mounting C3 for <= 6 contacts using single blocks in front mounting |

Environment

| | |
|--|---|
| Protective treatment | TH |
| Ambient air temperature for storage | -40...70 °C |
| Ambient air temperature for operation | -25...70 °C |
| Class of protection against electric shock | Class I conforming to IEC 60536 |
| IP degree of protection | IP69K conforming to IEC 60529 |
| NEMA degree of protection | NEMA 4X NEMA 13 |
| IK degree of protection | IK06 conforming to IEC 50102 |
| Standards | EN/IEC 60947-1 EN/IEC 60947-5-1 EN/IEC 60947-5-4 EN/IEC 60947-5-5 UL 508 GB 14048.5 CSA C22.2 No 14 |

| | |
|------------------------|--|
| Product certifications | BV CSA DNV GL LROS (Lloyds register of shipping) RINA UL listed |
| Vibration resistance | 5 gn (f = 2...500 Hz) conforming to IEC 60068-2-6 |
| Shock resistance | 50 gn for 11 ms half sine wave acceleration conforming to IEC 60068-2-27 30 gn for 18 ms half sine wave acceleration conforming to IEC 60068-2-27 |

Dimensions

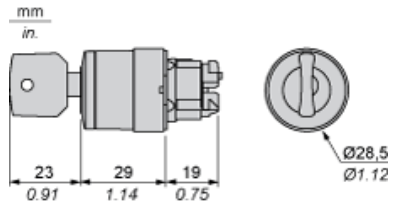

Panel Cut-out for Pushbuttons, Switches and Pilot Lights (Finished Holes, Ready for Installation)

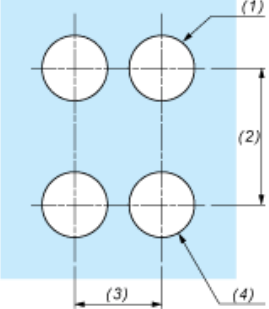
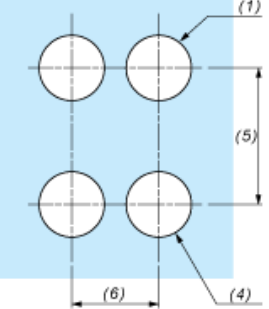
| Connection by Screw Clamp Terminals or Plug-in Connectors or on Printed Circuit Board | Connection by Faston Connectors |
|---|--|
|  |  |
| <p>(1) Diameter on finished panel or support (2) 40 mm min. / 1.57 in. min. (3) 30 mm min. / 1.18 in. min. (4) $\varnothing 22.5 \text{ mm} / 0.89 \text{ in.}$ recommended ($\varnothing 22.3 \text{ mm}_0^{+0.4} / 0.88 \text{ in.}_0^{+0.016}$) (5) 45 mm min. / 1.78 in. min. (6) 32 mm min. / 1.26 in. min.</p> | |

Pushbuttons, Switches and Pilot Lights for Printed Circuit Board Connection

Panel Cut-outs (Viewed from Installer's Side)

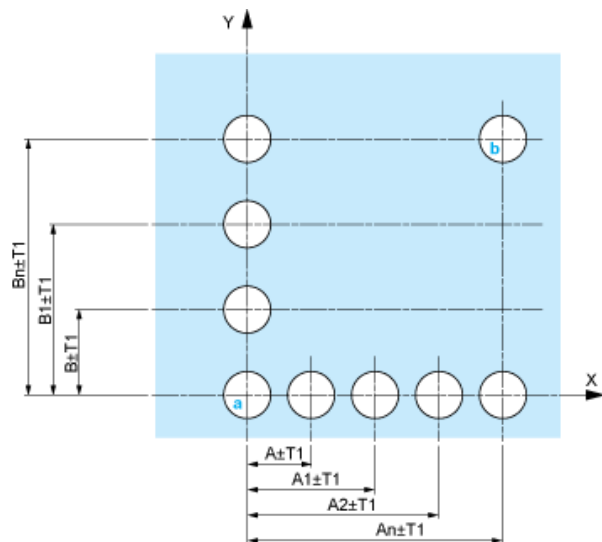

- A: 30 mm min. / 1.18 in. min.
 B: 40 mm min. / 1.57 in. min.



- (1) Panel
(2) Printed circuit board

Mounting of Adapter (Socket) ZBZ 01•

- 1 2 elongated holes for ZBZ 006 screw access
- 2 1 hole \varnothing 2.4 mm \pm 0.05 / 0.09 in. \pm 0.002 for centring adapter ZBZ 01•
- 3 8 \times \varnothing 1.2 mm / 0.05 in. holes
- 4 1 hole \varnothing 2.9 mm \pm 0.05 / 0.11 in. \pm 0.002, for aligning the printed circuit board (with cut-out marked a)
- 5 1 elongated hole for aligning the printed circuit board (with cut-out marked b)
- 6 4 holes \varnothing 2.4 mm / 0.09 in. for clipping in adapter ZBZ 01•

Dimensions An + 18.1 relate to the \varnothing 2.4 mm \pm 0.05 / 0.09 in. \pm 0.002 holes for centring adapter ZBZ 01•.

Electrical Composition Corresponding to Code C3



Electrical Composition Corresponding to Code C4



Electrical Composition Corresponding to Code C5



Electrical Composition Corresponding to Code C6



Electrical Composition Corresponding to Code C7



Electrical Composition Corresponding to Code C8

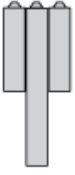

Electrical Composition Corresponding to Codes C9, C11, SF1 and SR1



Electrical Composition Corresponding to Code C15

1 N/O

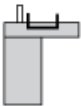

1 N/C



1 N/O + N/C or 1 N/O + N/O or 1 N/C + N/C

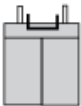

Legend

Single contact



Double contact



Light block



Possible location



Sequence of Contacts Fitted to 2-position Selector Switch Body

Position 315°



| | | | | | |
|----------|----------|--------|--------|--------|------|
| Push | Position | Top | | | |
| Bottom | | | | | |
| Location | | Left | Centre | Right | |
| State | | 0 | 0 | 0 | |
| Contacts | N/O | | open | open | open |
| N/C | | closed | closed | closed | |

Position 45°



| | | | | | |
|----------|----------|------|--------|--------|--------|
| Push | Position | Top | | | |
| Bottom | | | | | |
| Location | | Left | Centre | Right | |
| State | | 1 | 1 | 1 | |
| Contacts | N/O | | closed | closed | closed |
| N/C | | open | open | open | |