



Main

Commercial Status	Commercialised
Range of product	Harmony XB4
Product or component type	Head for selector switch
Device short name	ZB4
Bezel material	Chromium plated metal
Mounting diameter	22 mm
Sale per indivisible quantity	1
Shape of signaling unit head	Round
Type of operator	Spring return
Operator profile	Black toggle switch
Operator position information	2 positions 90°

Complementary

CAD overall width	29 mm
CAD overall height	29 mm
CAD overall depth	45 mm
Product weight	0.026 kg
Resistance to high pressure washer	7000000 Pa at 55 °C, distance: 0.1 m
Mechanical durability	500000 cycles
Electrical composition code	C13 for ≤ 6 contacts using single and double blocks in front mounting C15 for 1 contacts using single blocks in front mounting C12 for ≤ 6 contacts using single blocks in front mounting C11 for ≤ 3 contacts using single blocks in front mounting

Environment

Protective treatment	TH
Ambient air temperature for storage	-40...70 °C
Ambient air temperature for operation	-25...70 °C
Class of protection against electric shock	Class I conforming to IEC 60536
IP degree of protection	IP66 conforming to IEC 60529
NEMA degree of protection	NEMA 4X NEMA 13
IK degree of protection	IK06 conforming to IEC 50102
Standards	EN/IEC 60947-1 EN/IEC 60947-5-1 EN/IEC 60947-5-4 EN/IEC 60947-5-5 JIS C 4520 UL 508 CSA C22.2 No 14
Product certifications	BV CSA DNV GL LROS (Lloyds register of shipping) RINA UL listed

Vibration resistance	5 gn (f = 2...500 Hz) conforming to IEC 60068-2-6
Shock resistance	50 gn for 11 ms half sine wave acceleration conforming to IEC 60068-2-27 30 gn for 18 ms half sine wave acceleration conforming to IEC 60068-2-27

Dimensions

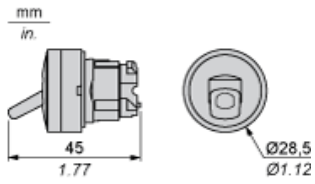

Panel Cut-out for Pushbuttons, Switches and Pilot Lights (Finished Holes, Ready for Installation)

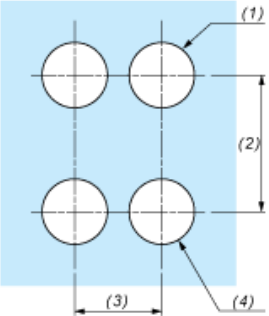
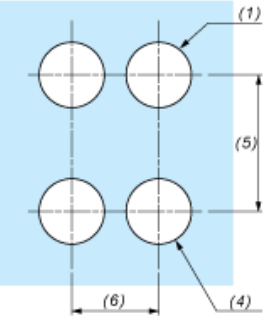
Connection by Screw Clamp Terminals or Plug-in Connectors or on Printed Circuit Board	Connection by Faston Connectors
	
<p>(1) Diameter on finished panel or support (2) 40 mm min. / 1.57 in. min. (3) 30 mm min. / 1.18 in. min. (4) $\varnothing 22.5 \text{ mm} / 0.89 \text{ in.}$ recommended ($\varnothing 22.3 \text{ mm}_0^{+0.4} / 0.88 \text{ in.}_0^{+0.016}$) (5) 45 mm min. / 1.78 in. min. (6) 32 mm min. / 1.26 in. min.</p>	

Pushbuttons, Switches and Pilot Lights for Printed Circuit Board Connection

Panel Cut-outs (Viewed from Installer's Side)

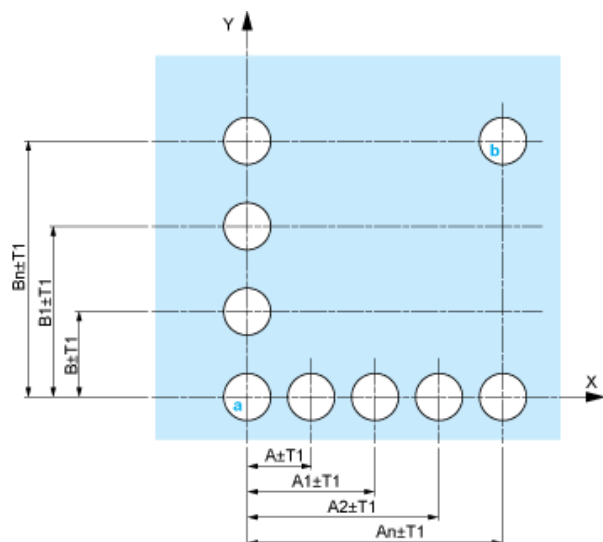

- A: 30 mm min. / 1.18 in. min.
 B: 40 mm min. / 1.57 in. min.

Printed Circuit Board Cut-outs (Viewed from Electrical Block Side)

Dimensions in mm



A: 30 mm min.

B: 40 mm min.

Dimensions in in.



A: 1.18 in. min.

B: 1.57 in. min.

General Tolerances of the Panel and Printed Circuit Board

The cumulative tolerance must not exceed 0.3 mm / 0.012 in: $T1 + T2 = 0.3 \text{ mm max.}$

Installation Precautions

- Minimum thickness of circuit board: 1.6 mm / 0.06 in.
- Cut-out diameter: 22.4 mm \pm 0.1 / 0.88 in. \pm 0.004
- Orientation of body/fixing collar ZB4 BZ009: $\pm 2^\circ 30'$ (excluding cut-outs marked a and b).
- Tightening torque of screws ZBZ 006: 0.6 N.m (5.3 lbf.in) max.
- Allow for one ZB4 BZ079 fixing collar/pillar and its fixing screws:
 - every 90 mm / 3.54 in. horizontally (X), and 120 mm / 4.72 in. vertically (Y).
 - with each selector switch head (ZB4 BD•, ZB4 BJ•, ZB4 BG•).

The fixing centers marked a and b are diagonally opposed and must align with those marked 4 and 5.



- (1) Panel
 (2) Printed circuit board

Mounting of Adapter (Socket) ZBZ 01•

- 1 2 elongated holes for ZBZ 006 screw access
- 2 1 hole $\varnothing 2.4 \text{ mm} \pm 0.05 / 0.09 \text{ in.} \pm 0.002$ for centring adapter ZBZ 01•
- 3 $8 \times \varnothing 1.2 \text{ mm} / 0.05 \text{ in.}$ holes
- 4 1 hole $\varnothing 2.9 \text{ mm} \pm 0.05 / 0.11 \text{ in.} \pm 0.002$, for aligning the printed circuit board (with cut-out marked a)
- 5 1 elongated hole for aligning the printed circuit board (with cut-out marked b)
- 6 4 holes $\varnothing 2.4 \text{ mm} / 0.09 \text{ in.}$ for clipping in adapter ZBZ 01•

Dimensions An + 18.1 relate to the $\varnothing 2.4 \text{ mm} \pm 0.05 / 0.09 \text{ in.} \pm 0.002$ holes for centring adapter ZBZ 01•.

Electrical Composition Corresponding to Codes C9, C11, SF1 and SR1



Electrical Composition Corresponding to Code C12



Electrical Composition Corresponding to Code C13

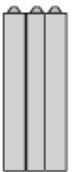

Electrical Composition Corresponding to Code C15

1 N/O

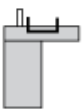

1 N/C

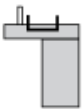

1 N/O + N/C or 1 N/O + N/O or 1 N/C + N/C

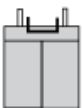

Legend

Single contact



Double contact



Light block



Possible location

