



Programmable Controller
MELSEC iQ-F

MELSEC iQ-F FX5-8AD

Hardware Manual



Manual Number	JY997D73901
Revision	A
Date	March 2017

This manual describes the part names, dimensions, installation, and specifications of the product. Before use, read this manual and manuals of relevant products fully to acquire proficiency in handling and operating the product. Make sure to learn all the product information, safety information, and precautions.

And, store this manual in a safe place so that you can take it out and read it whenever necessary. Always forward it to the end user.

Registration:
The company name and the product name to be described in this manual are the registered trademarks or trademarks of each company.

Effective March 2017
Specifications are subject to change without notice.

© 2017 MITSUBISHI ELECTRIC CORPORATION

Safety Precautions (Read these precautions before use.)

This manual classifies the safety precautions into two categories:

WARNING and **CAUTION**

WARNING	Indicates that incorrect handling may cause hazardous conditions, resulting in death or severe injury.
CAUTION	Indicates that incorrect handling may cause hazardous conditions, resulting in minor or moderate injury or property damage.

Depending on the circumstances, procedures indicated by **CAUTION** may also cause severe injury.
It is important to follow all precautions for personal safety.

Associated Manual

Manual name	Manual No.	Description
MELSEC iQ-F FX5 User's Manual (Analog Control - Intelligent function module)	SH-081802ENG	Explains multiple input module (voltage input, current input, thermocouple and resistance temperature detector).
MELSEC iQ-F FX5U User's Manual (Hardware)	JY997D55301	Explains FX5U CPU module specification details for I/O, wiring, installation, and maintenance.
MELSEC iQ-F FX5UC User's Manual (Hardware)	JY997D61401	Explains FX5UC CPU module specification details for I/O, wiring, installation, and maintenance.

How to obtain manuals
For the necessary product manuals or documents, consult with your local Mitsubishi Electric representative.

Applicable standards

FX5-8AD complies with the EC Directive (EMC Directive) and UL standards (UL, cUL). Further information can be found in the following manual.
→ MELSEC iQ-F FX5 User's Manual (Analog Control - Intelligent function module)
Regarding the standards that relate to the CPU module, please refer to either the product catalog or consult with your local Mitsubishi Electric representative.

Attention
This product is designed for use in industrial applications.

1. Outline

FX5-8AD multiple input module (hereinafter called FX5-8AD) can convert 8 points of analog input values (voltage input, current input, thermocouple and resistance temperature detector) into digital values.

1.1 Incorporated Items

Check that the following product and items are included in the package:

Product	FX5-8AD multiple input module
Included Items	FX2NC-100MPCB power cable: (1 m, three wire) Dust proof protection sheet (1 sheet) Hardware manual (This manual)

1.2 External Dimensions, Part Names

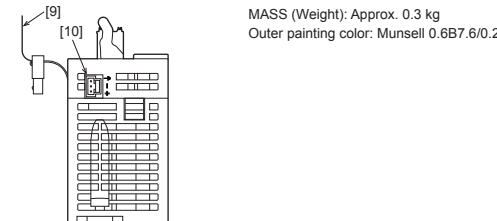
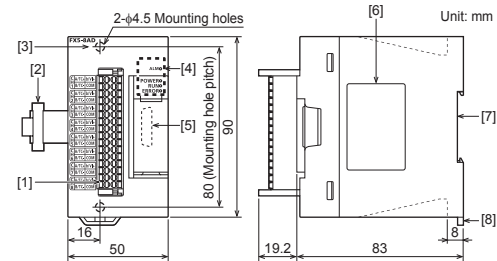

Unit: mm
MASS (Weight): Approx. 0.3 kg
Outer painting color: Munsell 0.6B7.6/0.2

- [1] Terminal block (Spring clamp terminal block)
- [2] Extension cable
- [3] Direct mounting hole: 2 holes of φ4.5 (mounting screw: M4 screw)
- [4] Operation status display LEDs
- [5] Extension connector (for next module)
- [6] Name plate
- [7] DIN rail mounting groove (DIN rail: DIN 46277, 35 mm wide)
- [8] DIN rail mounting hook
- [9] Pullout tab
- [10] Power connector

1.3 Indications of LEDs

LED display	LED color	Status	Indication
POWER	Green	On	Power on
		Off	Power off or module failure
RUN	Green	On	Normal operation
		Flashing	Offset/gain setting mode
ERROR	Red	On	Minor error or major error
		Flashing	Moderate error or major error
		Off	Normal operation
ALM	Red	On	Process alarm or rate alarm issued
		Flashing	Input signal error or disconnection detection detected
		Off	Normal operation

1.4 Terminal Layout

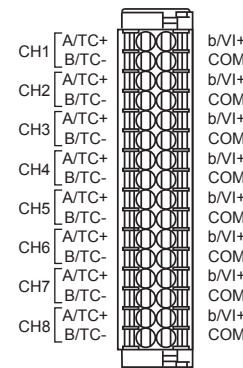

For further information on terminal, refer to the following manual.
→ MELSEC iQ-F FX5 User's Manual (Analog Control - Intelligent function module)

2. Installation

INSTALLATION PRECAUTIONS **WARNING**

- Make sure to cut off all phases of the power supply externally before attempting installation or wiring work. Failure to do so may cause electric shock or damage to the product.
- Use the product within the generic environment specifications described in the User's Manual (Hardware) for the CPU module to be used. Never use the product in areas with excessive dust, oily smoke, conductive dusts, corrosive gas (salt air, Cl₂, H₂S, SO₂ or NO₂), flammable gas, vibration or impacts, or expose it to high temperature, condensation, or rain and wind. If the product is used in such conditions, electric shock, fire, malfunctions, deterioration or damage may occur.

INSTALLATION PRECAUTIONS **CAUTION**

- Do not touch the conductive parts of the product directly. Doing so may cause device failures or malfunctions.
- When drilling screw holes or wiring, make sure that cutting and wiring debris do not enter the ventilation slits of the PLC. Failure to do so may cause fire, equipment failures or malfunctions.
- The dust proof sheet should be affixed to the ventilation slits before installation and wiring work to block foreign objects such as cutting and wiring debris. However, when the installation work is completed, make sure to remove the sheet to provide adequate ventilation. Failure to do so may cause fire, equipment failures or malfunctions.
- Install the product on a flat surface. If the mounting surface is rough, undue force will be applied to the PC board, thereby causing nonconformities.
- Install the product securely using a DIN rail or mounting screws.
- Connect the extension cables securely to their designated connectors. Loose connections may cause malfunctions.

For further information on mounting, refer to the following manual.
→ MELSEC iQ-F FX5U User's Manual (Hardware)
→ MELSEC iQ-F FX5UC User's Manual (Hardware)

3. Wiring

WIRING PRECAUTIONS **WARNING**

- Make sure to cut off all phases of the power supply externally before attempting installation or wiring work. Failure to do so may cause electric shock or damage to the product.
- Make sure to properly wire to the spring clamp terminal block in accordance with the following precautions. Failure to do so may cause electric shock, equipment failures, a short-circuit, wire breakage, malfunctions, or damage to the product.
 - The disposal size of the cable end should follow the dimensions described in the manual.
 - Twist the ends of stranded wires and make sure that there are no loose wires.
 - Do not solder-plate the electric wire ends.
 - Do not connect more than the specified number of wires or electric wires of unspecified size.
 - Affix the electric wires so that neither the terminal block nor the connected parts are directly stressed.

WIRING PRECAUTIONS **CAUTION**

- Make sure to observe the following precautions in order to prevent any damage to the machinery or accidents due to malfunction of the PLC caused by abnormal data written to the PLC due to the effects of noise:
 - Do not bundle the power line and communication cables together with or lay them close to the main circuit, high-voltage line, load line or power line. As a guideline, lay the power line, control line and communication cables at least 100 mm away from the main circuit, high-voltage line, load line or power line.
 - Ground the shield of the analog input/output cable at one point on the signal receiving side. However, do not use common grounding with heavy electrical systems.
- Check the interface type and correctly connect the cable. Incorrect wiring (connecting the cable to an incorrect interface) may cause failure of the module and external device.
- To terminal blocks or power connectors, connect circuits isolated from hazardous voltage by double/reinforced insulation.

3.1 Applicable Cable

3.1.1 Spring clamp terminal block

1) Suitable wiring

No. of wire per terminal	Wire size		Temperature rating
	Single wire, Strand wire (Material: Copper wire)	Ferrules with insulation sleeve	
One wire	AWG24 to 16 (0.2 to 1.5 mm ²)	AWG23 to 19 (0.25 to 0.75 mm ²)	80°C or more

2) Wire end treatment

Strip the cable about 10 mm from the tip to connect a wire ferrule at the striped area. Failure to do so may result in electric shock or short circuit between adjacent terminals because the conductive part. If the wire strip length is too short, it may result in the poor contact to the spring clamp terminal part. When using a wire ferrule with an insulating sleeve, choose a wire with proper cable sheath referring to the above outside dimensions, otherwise the wire cannot be inserted easily.

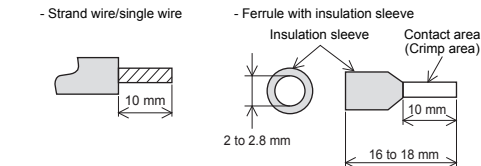

The following table shows wire ferrules and tools for wire ferrules compatible with the terminal block. Use of items other than these may result in not being able to remove the wire ferrule, so carefully check that the wire ferrule can be unplugged.
<Reference product>

Manufacturer	Model	Wire size	Crimp tool
PHOENIX CONTACT GmbH & Co. KG	Al 0.5-10 WH	0.5 mm ²	CRIMPFOX 6
	Al 0.75-10 GY	0.75 mm ²	
	Al 1.0-10	1.0 mm ²	
	Al 1.5-10	1.5 mm ²	

3) Connecting a cable

- When ferrules with insulation sleeve are used
Insert a wire with the ferrule with insulation sleeve into the wire insertion opening and push the wire.
- When stranded wires and solid wires are used
Push the open/close button of the terminal block with a flathead screwdriver. While pushing the open/close button, insert the wire into the insertion opening until the wire reaches the back, and then release the open/close button.
Then, pull the wire lightly and check that it is clamped securely.
<Reference>

Manufacturer	Model
PHOENIX CONTACT GmbH & Co. KG	SZS 0.4×2.5 VDE

4) Disconnecting a cable

Push the open/close button of the wire to be disconnected with a flathead screwdriver. Pull out the wire with the open/close button pushed.

3.2 Example of Input Wiring

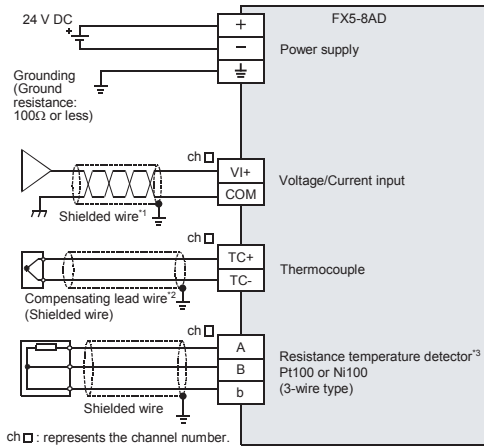

*1 For analog input wiring, use shielded twisted-pair cables (double-core type). Separate them from other power lines or lines which are sensitive to induction.

*2 When using a thermocouple, use specified compensating lead wires.

*3 When using a resistance temperature detector, use lead wires of equal, low resistance.

3.2.1 Power connector

For further information on the power supply wiring and power cable, refer to the following manual.

→ MELSEC IQ-F FX5 User's Manual (Analog Control - Intelligent function module)

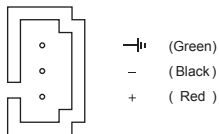

3.3 Grounding

Ground the PLC as stated below.

- Perform class D grounding. (Grounding resistance: 100 Ω or less)
 - Ground the PLC independently if possible.
- If the PLC cannot be grounded independently, perform the "Shared grounding" shown below.

For details, refer to the following manual.

→ MELSEC IQ-F FX5U User's Manual (Hardware)

→ MELSEC IQ-F FX5UC User's Manual (Hardware)

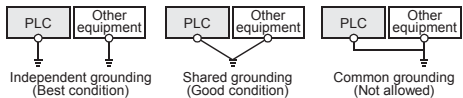

- Bring the grounding point close to the PLC as much as possible so that the ground cable can be shortened.

4. Specification

DESIGN PRECAUTIONS	WARNING
<ul style="list-style-type: none"> Make sure to set up the following safety circuits outside the PLC to ensure safe system operation even during external power supply problems or PLC failure. Otherwise, malfunctions may cause serious accidents. <ul style="list-style-type: none"> Most importantly, set up the following: an emergency stop circuit, a protection circuit, an interlock circuit for opposite movements (such as normal vs. reverse rotation), and an interlock circuit (to prevent damage to the equipment at the upper and lower positioning limits). Note that when the CPU module detects an error, such as a watchdog timer error, during self-diagnosis, all outputs are turned off. Also, when an error that cannot be detected by the CPU module occurs in an input/output control block, output control may be disabled. External circuits and mechanisms should be designed to ensure safe machinery operation in such a case. 	

DESIGN PRECAUTIONS	CAUTION
<ul style="list-style-type: none"> Simultaneously turn on and off the power supplies of the CPU module and extension modules. 	

STARTUP AND MAINTENANCE PRECAUTIONS	CAUTION
<ul style="list-style-type: none"> Do not disassemble or modify the PLC. Doing so may cause fire, equipment failures, or malfunctions. For repair, contact your local Mitsubishi Electric representative. Do not drop the product or exert strong impact to it. Doing so may cause damage. 	

DISPOSAL PRECAUTIONS	CAUTION
<ul style="list-style-type: none"> Please contact a certified electronic waste disposal company for the environmentally safe recycling and disposal of your device. 	

TRANSPORTATION PRECAUTIONS	CAUTION
<ul style="list-style-type: none"> The product is a precision instrument. During transportation, avoid impacts larger than those specified in the general specifications by using dedicated packaging boxes and shock-absorbing palettes. Failure to do so may cause failures in the product. After transportation, verify operation of the product and check for damage of the mounting part, etc. 	

4.1 Applicable CPU module

Model name	Applicability
FX5U CPU module	Ver. 1.050 or later
FX5UC CPU module*1	Ver. 1.050 or later

*1 FX5-CNV-IFC or FX5-C1PS-SV is necessary to connect FX5-BAD to the FX5UC CPU module.

4.2 General Specifications

The items other than the following are equivalent to those of the CPU module.

For the general specification, refer to the following manual.

→ MELSEC IQ-F FX5U User's Manual (Hardware)

→ MELSEC IQ-F FX5UC User's Manual (Hardware)

Items	Specifications
Dielectric withstand voltage	500 V AC for 1 minute
Insulation resistance	10 MΩ or higher by 500 V DC insulation resistance tester

Between all terminals and ground terminal

4.3 Power Supply Specifications

Items	Specifications
Power supply voltage	24 V DC +20%, -15%
External power supply	Operation continues when the instantaneous power failure is shorter than 5 ms.
Current consumption	100 mA
Internal power supply	Power supply voltage: 24 V DC
Current consumption	40 mA

4.4 Performance Specifications

Items	Specifications	
Number of analog input points	8 points (8 channels)	
Conversion speed	Voltage/Current	1 ms/ch ¹
	Thermocouple/Resistance temperature detector	40 ms/ch
Isolation method	Between input terminal and PLC: Photocoupler Between input terminal and channels: Non-isolation	
Number of occupied I/O points	8 points	

*1 In the case of 2CH conversion mode, conversion speed is 1 ms/2ch.

4.5 Voltage/current input specifications

Items	Specifications			
Analog input voltage	-10 to +10 V DC (input resistance 1 MΩ)			
Analog input current	-20 to +20 mA DC (input resistance 250 Ω)			
Digital output value	16-bit signed binary (-32000 to +32000)			
Input characteristics, resolution*1	Analog input range	Digital output value	Resolution	
	Voltage	0 to 10 V	0 to 32000	312.5 μV
		0 to 5 V	0 to 32000	156.25 μV
		1 to 5 V	0 to 32000	125 μV
	Current	-10 to +10 V	-32000 to +32000	312.5 μV
		0 to 20 mA	0 to 32000	625 nA
4 to 20 mA		0 to 32000	500 nA	
	-20 to +20 mA	-32000 to +32000	625 nA	
Accuracy (accuracy for the full scale digital output value)	Ambient temperature 25±5°C: within ±0.3 % (±192 digit) Ambient temperature -20 to 55°C: within ±0.5 % (±320 digit)			
Absolute maximum input	Voltage: ±15 V, Current: ±30 mA			

*1 For the input characteristic, refer to the following.

→ MELSEC IQ-F FX5 User's Manual (Analog Control - Intelligent function module)

4.6 Thermocouple input specifications

Items	Specifications
Usable thermocouple	K, J, T, B, R, S
Resolution	K, J, T: 0.1°C (0.1 to 0.2°F) B, R, S: 0.1 to 0.3°C (0.1 to 0.6°F)
Temperature measuring range	K: -200 to +1200°C (-328.0 to +2192.0°F) J: -40 to +750°C (-40.0 to +1382.0°F) T: -200 to +350°C (-328.0 to +662.0°F) B: 600 to 1700°C (1112.0 to 3092.0°F) R: 0 to 1600°C (32.0 to 2912.0°F) S: 0 to 1600°C (32.0 to 2912.0°F)
Digital output value (16-bit signed binary)	K: -2000 to +12000 (-3280 to +21920) J: -400 to +7500 (-400 to +13820) T: -2000 to +3500 (-3280 to +6620) B: 6000 to 17000 (11120 to 30920) R: 0 to 16000 (320 to 29120) S: 0 to 16000 (320 to 29120)
Ambient temperature 25±5°C	K: ±3.5°C (-200°C to -150°C) K: ±2.5°C (-150°C to -100°C) K: ±1.5°C (-100°C to +1200°C) J: ±1.2°C T: ±3.5°C (-200°C to -150°C) T: ±2.5°C (-150°C to -100°C) T: ±1.5°C (-100°C to +350°C) B: ±2.3°C R: ±2.5°C S: ±2.5°C
Accuracy*1	Ambient temperature -20 to 55°C K: ±8.5°C (-200°C to -150°C) K: ±7.5°C (-150°C to -100°C) K: ±6.5°C (-100°C to +1200°C) J: ±3.5°C T: ±5.2°C (-200°C to -150°C) T: ±4.2°C (-150°C to -100°C) T: ±3.1°C (-100°C to +350°C) B: ±6.5°C R: ±6.5°C S: ±6.5°C

*1 To stabilize the accuracy, warm-up (supply power) the system for 30 minutes or more after power-on.

4.7 Resistance temperature detector input specifications

Items	Specifications	
Usable resistance temperature detector*1	Pt100, Ni100	
Resolution	0.1°C (0.2°F)	
Temperature measuring range	Pt100: -200 to +850°C (-328 to +1562°F) Ni100: -60 to +250°C (-76 to +482°F)	
Digital output value (16-bit signed binary)	Pt100: -2000 to +8500 (-3280 to +15620) Ni100: -600 to +2500 (-760 to +4820)	
Accuracy	Ambient temperature 25±5°C	Pt100: ±0.8°C Ni100: ±0.4°C
	Ambient temperature -20 to 55°C	Pt100: ±2.4°C Ni100: ±1.2°C

*1 Only 3-wire type resistance temperature detectors can be used.

This manual confers no industrial property rights or any rights of any other kind, nor does it confer any patent licenses. Mitsubishi Electric Corporation cannot be held responsible for any problems involving industrial property rights which may occur as a result of using the contents noted in this manual.

Warranty

Exclusion of loss in opportunity and secondary loss from warranty liability
Regardless of the gratis warranty term, Mitsubishi shall not be liable for compensation to:

- Damages caused by any cause found not to be the responsibility of Mitsubishi.
- Loss in opportunity, lost profits incurred to the user by Failures of Mitsubishi products.
- Special damages and secondary damages whether foreseeable or not, compensation for accidents, and compensation for damages to products other than Mitsubishi products.
- Replacement by the user, maintenance of on-site equipment, start-up test run and other tasks.

⚠ For safe use

- This product has been manufactured as a general-purpose part for general industries, and has not been designed or manufactured to be incorporated in a device or system used in purposes related to human life.
- Before using the product for special purposes such as nuclear power, electric power, aerospace, medicine or passenger movement vehicles, consult with Mitsubishi Electric.
- This product has been manufactured under strict quality control. However when installing the product where major accidents or losses could occur if the product fails, install appropriate backup or failsafe functions in the system.

MITSUBISHI ELECTRIC CORPORATION

HEAD OFFICE : TOKYO BUILDING, 2-7-3 MARUNOUCHI, CHIYODA-KU, TOKYO 100-8310, JAPAN