

User Manual

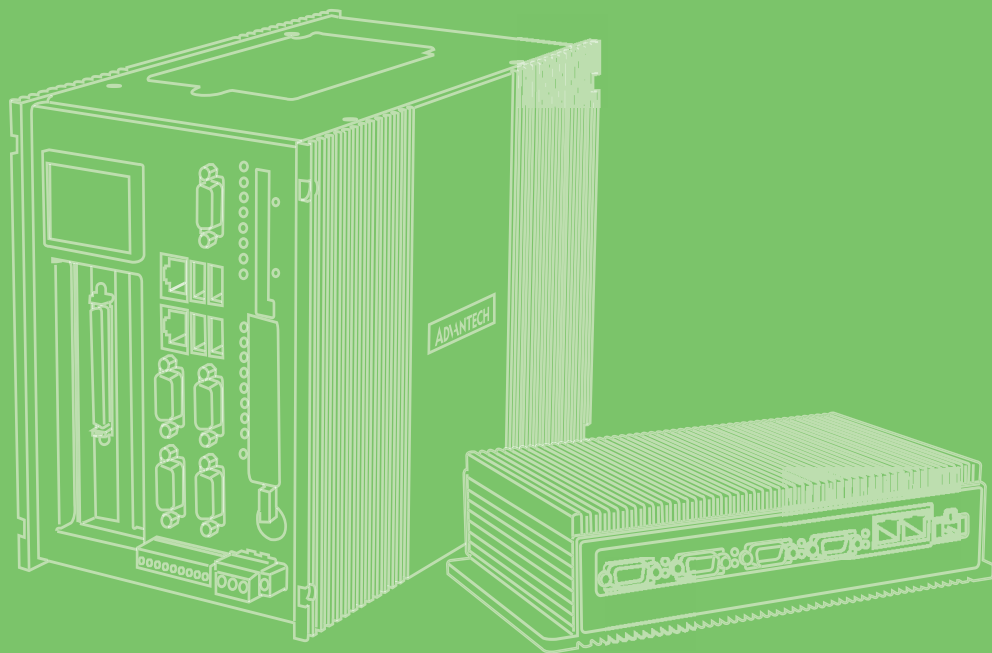

## UNO-1251G

嵌入式工業電腦

**ARM<sup>®</sup> Coretex<sup>®</sup>-A8 Micro DIN-Rail Industrial IoT gateway w/  
2 x LAN, 1 x USB, 1 x CAN, 3 x COM, 2 x MicroSD,  
1 x MicroSIM**

**ADVANTECH**

*Enabling an Intelligent Planet*

## Copyright

The documentation and the software included with this product are copyrighted 2016 by Advantech Co., Ltd. All rights are reserved. Advantech Co., Ltd. reserves the right to make improvements in the products described in this manual at any time without notice. No part of this manual may be reproduced, copied, translated or transmitted in any form or by any means without the prior written permission of Advantech Co., Ltd. Information provided in this manual is intended to be accurate and reliable. However, Advantech Co., Ltd. assumes no responsibility for its use, nor for any infringements of the rights of third parties, which may result from its use.

## Acknowledgements

ARM® and Cortex® are the trademark of ARM Limited.

All other product names or trademarks are properties of their respective owners.

### Support

For more information on this and other Advantech products, please visit our websites at: <http://www.advantech.com>

For technical support and service, please visit our support website at:

<http://support.advantech.com/>

\* UNO-1251G

UNO-1251G-A0AE

UNO-1251G-A5AE

UNO1251GA0A1601E-T      UNO1251GA0A1701E-T

UNO1251GA0A1602E-T      UNO1251GA0A1702E-T

UNO1251GA0A1603E-T      UNO1251GA0A1703E-T

UNO1251GA0A1604E-T      UNO1251GA0A1704E-T

UNO1251GA0A1605E-T      UNO1251GA0A1705E-T

UNO1251GA0A1606E-T      UNO1251GA0A1706E-T

UNO1251GA5A1601E-T      UNO1251GA5A1701E-T

UNO1251GA5A1602E-T      UNO1251GA5A1702E-T

UNO1251GA5A1603E-T      UNO1251GA5A1703E-T

UNO1251GA5A1604E-T      UNO1251GA5A1704E-T

UNO1251GA5A1605E-T      UNO1251GA5A1705E-T

UNO1251GA5A1606E-T      UNO1251GA5A1706E-T

UNO1251GA5A1801E-T      UNO1251GA5A1901E-T

UNO1251GA5A1802E-T      UNO1251GA5A1902E-T

WA-HU1251G-R15H0AE      WA-HU1251G-R15H001

WA-HU1251G-R15H0BE      WA-HU1251G-R15H002

WA-HU1251G-R15H0CE      WA-HU1251G-R15H003

WA-HU1251G-R15H0DE      WA-HU1251G-R15H004

WA-HU1251G-R50H0AE      WA-HU1251G-R15H005

Part No. 2003W25100

Printed in China

Edition 1

May 2016

WA-HU1251G-R50H0BE	WA-HU1251G-R15H006
WA-HU1251G-R50H0CE	WA-HU1251G-R15H007
WA-HU1251G-R50H0DE	WA-HU1251G-R15H008
WA-HU1251G-R15H009	WA-HU1251G-R15H010

## Product Warranty (2 years)

Advantech warrants to you, the original purchaser, that each of its products will be free from defects in materials and workmanship for two years from the date of purchase.

This warranty does not apply to any products which have been repaired or altered by persons other than repair personnel authorized by Advantech, or which have been subject to misuse, abuse, accident or improper installation. Advantech assumes no liability under the terms of this warranty as a consequence of such events.

Because of Advantech's high quality-control standards and rigorous testing, most of our customers never need to use our repair service. If an Advantech product is defective, it will be repaired or replaced at no charge during the warranty period. For out-of-warranty repairs, you will be billed according to the cost of replacement materials, service time and freight. Please consult your dealer for more details.

If you think you have a defective product, follow these steps:

1. Collect all the information about the problem encountered. (For example, CPU speed, Advantech products used, other hardware and software used, etc.) Note anything abnormal and list any onscreen messages you get when the problem occurs.
2. Call your dealer and describe the problem. Please have your manual, product, and any helpful information readily available.
3. If your product is diagnosed as defective, obtain an RMA (return merchandise authorization) number from your dealer. This allows us to process your return more quickly.
4. Carefully pack the defective product, a fully-completed Repair and Replacement Order Card and a photocopy proof of purchase date (such as your sales receipt) in a shippable container. A product returned without proof of the purchase date is not eligible for warranty service.
5. Write the RMA number visibly on the outside of the package and ship it prepaid to your dealer.

## Declaration of Conformity

### CE

This product has passed the CE test for environmental specifications when shielded cables are used for external wiring. We recommend the use of shielded cables. This kind of cable is available from Advantech. Please contact your local supplier for ordering information.

## FCC Class A

Note: This equipment has been tested and found to comply with the limits for a Class A digital device, pursuant to part 15 of the FCC Rules. These limits are designed to provide reasonable protection against harmful interference when the equipment is operated in a commercial environment. This equipment generates, uses, and can radiate radio frequency energy and, if not installed and used in accordance with the instruction manual, may cause harmful interference to radio communications. Operation of this equipment in a residential area is likely to cause harmful interference in which case the user will be required to correct the interference at his own expense.

## Technical Support and Assistance

1. Visit the Advantech web site at [www.advantech.com/support](http://www.advantech.com/support) where you can find the latest information about the product.
2. Contact your distributor, sales representative, or Advantech's customer service center for technical support if you need additional assistance. Please have the following information ready before you call:
  - Product name and serial number
  - Description of your peripheral attachments
  - Description of your software (operating system, version, application software, etc.)
  - A complete description of the problem
  - The exact wording of any error messages

## Safety Precaution - Static Electricity

Follow these simple precautions to protect yourself from harm and the products from damage.

- To avoid electrical shock, always disconnect the power from your PC chassis before you work on it. Don't touch any components on the CPU card or other cards while the PC is on.
- Disconnect power before making any configuration changes. The sudden rush of power as you connect a jumper or install a card may damage sensitive electronic components.

警告使用者：這是甲類資訊產品，在居住的環境中使用時，可能會造成射頻干擾，在這種情況下，使用者會被要求採取某些適當對策。

## Safety Instructions

1. Read these safety instructions carefully.
2. Keep this User Manual for later reference.
3. Disconnect this equipment from any AC outlet before cleaning. Use a damp cloth. Do not use liquid or spray detergents for cleaning.
4. For plug-in equipment, the power outlet socket must be located near the equipment and must be easily accessible.
5. Keep this equipment away from humidity.
6. Put this equipment on a reliable surface during installation. Dropping it or letting it fall may cause damage.
7. The openings on the enclosure are for air convection. Protect the equipment from overheating. **DO NOT COVER THE OPENINGS.**
8. Make sure the voltage of the power source is correct before connecting the equipment to the power outlet.
9. Position the power cord so that people cannot step on it. Do not place anything over the power cord.
10. All cautions and warnings on the equipment should be noted.
11. If the equipment is not used for a long time, disconnect it from the power source to avoid damage by transient overvoltage.
12. Never pour any liquid into an opening. This may cause fire or electrical shock.
13. Never open the equipment. For safety reasons, the equipment should be opened only by qualified service personnel.
14. If one of the following situations arises, get the equipment checked by service personnel:
  - The power cord or plug is damaged.
  - Liquid has penetrated into the equipment.
  - The equipment has been exposed to moisture.
  - The equipment does not work well, or you cannot get it to work according to the user's manual.
  - The equipment has been dropped and damaged.
  - The equipment has obvious signs of breakage.
15. **DO NOT LEAVE THIS EQUIPMENT IN AN ENVIRONMENT WHERE THE STORAGE TEMPERATURE MAY GO BELOW -20° C (-4° F) OR ABOVE 60° C (140° F) for UNO-1251G. THIS COULD DAMAGE THE EQUIPMENT. THE EQUIPMENT SHOULD BE IN A CONTROLLED ENVIRONMENT.**
16. **CAUTION: DANGER OF EXPLOSION IF BATTERY IS INCORRECTLY REPLACED. REPLACE ONLY WITH THE SAME OR EQUIVALENT TYPE RECOMMENDED BY THE MANUFACTURER, DISCARD USED BATTERIES ACCORDING TO THE MANUFACTURER'S INSTRUCTIONS.**
17. **ATTENTION: Danger d'explosion si la batterie est mal REMPLACÉ. REMPLACER UNIQUEMENT PAR LE MEME TYPE OU EQUIVALENT RECOMMANDÉ PAR LE FABRICANT, jeter les piles usagées SELON LES INSTRUCTIONS DU FABRICANT.**
18. The sound pressure level at the operator's position according to IEC 704-1:1982 is no more than 70 dB (A).

**DISCLAIMER:** This set of instructions is given according to IEC 704-1. Advantech disclaims all responsibility for the accuracy of any statements contained herein.

BSMI-ROHS 限用物質含有情況說明書

設備名稱： 電腦 ， 型號（型式）： UNO-1251G Equipment name Type designation (Type)						
單元 Unit	限用物質及其化學符號 Restricted substances and its chemical symbols					
	鉛 Lead (Pb)	汞 Mercury (Hg)	鎘 Cadmium (Cd)	六價鉻 Hexavalent chromium (Cr <sup>+6</sup> )	多溴聯苯 Poly-brominated biphenyls (PBB)	多溴二苯醚 Polybrominated diphenyl ethers (PBDE)
電路板	—	○	○	○	○	○
機殼 (外殼、支架…等)	○	○	○	○	○	○
其它固定組件 (螺絲)	○	○	○	○	○	○
配件 (線材)	—	○	○	○	○	○
儲存	○	○	○	○	○	○
OLED 面板	○	○	○	○	○	○
備考 1. “超出 0.1 wt %” 及 “超出 0.01 wt %” 係指限用物質之百分比含量超出百分比含量基準值。 Note 1 : “Exceeding 0.1 wt %” and “exceeding 0.01 wt %” indicate that the percentage content of the restricted substance exceeds the reference percentage value of presence condition. 備考 2. “○” 係指該項限用物質之百分比含量未超出百分比含量基準值。 Note 2 : “○” indicates that the percentage content of the restricted substance does not exceed the percentage of reference value of presence 備考 3. “—” 係指該項限用物質為排除項目。 Note 3 : The “—” indicates that the restricted substance corresponds to the exemption						

## 安全指示

1. 請仔細閱讀此安全操作說明。
2. 請妥善保存此用戶手冊供日後參考。
3. 用濕抹布清洗設備前，請確認拔除電源線。請勿使用液體或去污噴霧劑清洗設備。
4. 對於使用電源線的設備，設備周圍必須有容易接觸到的電源插座。
5. 請勿在潮濕環境中試用設備。
6. 請在安裝前確保設備放置在可靠的平面上，意外摔落可能會導致設備損壞。
7. 設備機殼的開孔適用於空氣對，從而防止設備過熱。**請勿覆蓋開孔。**
8. 當您連接設備到電源插座前，請確認電源插座的電壓符合要求。
9. 請將電源線佈置在人們不易絆倒的位置，請勿在電源線上覆蓋任何雜物。
10. 請注意設備上所有的警告標示。
11. 如果長時間不使用設備，請拔除與電源插座的連結，避免設備被超標的電壓波動損壞。
12. 請勿讓任何液體流入通風口，以免引起火災或短路。
13. 請勿自行打開設備。為了確保您的安全，請透過經認證的工程師來打開設備。
14. 如遇下列情況，請由專業人員維修：
  - 電源線或插頭損壞；
  - 設備內部有液體流入；
  - 設備曾暴露在過度潮濕環境中使用；
  - 設備無法正常工作，或您無法透過用戶手冊來正常工作；
  - 設備摔落或損壞；
  - 設備有明顯外觀損；
15. 請勿將設備放置在超出建議溫度範圍的環境，即不要低於  $-20^{\circ}\text{C}$  ( $-4^{\circ}\text{F}$ ) 或高於  $60^{\circ}\text{C}$  ( $140^{\circ}\text{F}$ )，否則可能會造成設備損壞。
16. **注意：**若電池更換不正確，將有爆炸危險。因此，只可以使用製造商推薦的同一種或者同等型號的電池進行替換。請按照製造商的指示處理舊電池。
17. 根據 IEC 704-1:1982 規定，操作員所在位置音量不可高於 70 分貝。
18. **限制區域：**請勿將設備安裝於限制區域使用。
19. **免責聲明：**請安全訓示符合 IEC 704-1 要求。研華公司對其內容之準確性不承擔任何法律責任。





# Contents

<b>Chapter 1</b>	<b>Overview.....</b>	<b>1</b>
1.1	Introduction .....	2
1.2	Specifications .....	2
1.3	Safety Precautions .....	3
1.4	Accessories.....	4
<b>Chapter 2</b>	<b>Hardware Functionality .....</b>	<b>5</b>
2.1	Introduction .....	6
	Figure 2.1 Front Panel of UNO-1251G .....	6
	Figure 2.2 Top Panel of UNO-1251G .....	6
	Figure 2.3 Bottom Panel of UNO-1251G .....	6
	Figure 2.4 Left Panel of UNO-1251G .....	7
2.2	Serial Connections .....	7
	2.2.1 Serial Mode and Terminator Resistor Selection .....	7
	2.2.2 Debug Port.....	8
2.3	Ethernet LAN Connector .....	8
2.4	LED Indicators.....	8
2.5	OLED Indicators.....	8
2.6	Power Connector .....	8
2.7	USB Connector .....	9
2.8	CAN Port .....	9
2.9	Reset Button .....	9
2.10	Antenna Mounting .....	9
2.11	microSD card Slot .....	9
2.12	Micro SIM card Slot.....	10
2.13	PCI Express Mini Card Socket.....	10
<b>Chapter 3</b>	<b>Initial Setup .....</b>	<b>11</b>
3.1	Chassis Grounding.....	12
	Figure 3.1 Chassis Grounding Connection.....	12
3.2	Inserting a microSD card/microSIM card (Optional).....	12
3.3	Installing a Wireless module Card and Antenna (Optional) .....	13
3.4	Din-rail Kit Assembly .....	14
	Figure 3.2 UNO-1251G with Din-rail mounting .....	14
3.5	Connecting Power .....	15
3.6	Remote Access .....	15
<b>Appendix A</b>	<b>System Settings and Pin Assignments</b>	<b>17</b>
	.....	
A.1	Board Connectors and Switches.....	18
	Figure A.1 Connector & Switch Locations (front).....	18
	Table A.1: Connectors and Jumpers .....	18
A.2	RS-485 Serial Port (COM1), RS-422/485 Serial Port (COM2) and console port.....	19
	Table A.2: Connectors and Jumpers .....	19
A.3	Switch setting of RS-485 Serial Port (COM1) & RS-422/485 Serial Port (COM2) .....	20
A.4	RS-232 Serial Port (COM3) .....	20
	Table A.3: Connectors and Jumpers .....	20

---

A.5	CAN Port.....	21
	Table A.4: Connectors and Jumpers .....	21
A.6	Switch setting of CAN port .....	21
A.7	Power Connector .....	22
	Table A.5: Connectors and Jumpers .....	22
A.8	USB Connector .....	22
	Table A.6: Connectors and Pin Assignments .....	22
A.9	LAN Connector .....	23
	Table A.7: Connectors and Pin Assignments .....	23

# Chapter 1

## Overview

This chapter provides an overview of UNO-1251G specifications.

Sections include:

- Introduction
- Safety precautions
- Accessories

## 1.1 Introduction

The UNO-1251G is an Industrial IoT DIN-rail gateway. This gateway features dual LAN ports & expansible Wi-Fi/3G connectivity. There are also some user friendly design elements such as: a programmable OLED display to indicate the system status; and a front accessible microSD card/micro SIM slot. With WebAccess/HMI support, it is compatible with 450 types of PLC, controllers & I/O devices. User can easily access UNO-1251G through mobile devices by VNC. It is the ideal solution for automation control as a cloud enabled HMI platform.

## 1.2 Specifications

### General

■ Certification	CE, FCC, CCC, BSMI, UL
■ Dimensions ( W x D x H )	50 x 90 x 100 mm (1.97" x 3.54" x 3.94")
■ Form Factor	Micro Size
■ Enclosure	Aluminum Housing
■ Mounting	DIN-rail
■ Weight (Net)	0.4 kg (0.88 lbs)
■ Power Requirements	10~36 VDC
■ Power Consumption	5.3W(Typical), 20W(Maximum)
■ OS Support	WEC7 / Embedded Linux (kernel v2.6.37)

### System Hardware

■ Processor	RISC 32 bit, 600 MHz (ARM® Cortex™-A8)
■ Backup Memory	FRAM 128KB
■ Memory Onboard	DDR2 256MB 166MHz (Optional 512MB)
■ LED Indicators	LEDs for Power(PWR), COM1~3(Tx/Rx) and CAN(Tx/Rx)
■ Storage	Bootloader and image: 1 x microSD 1G (Built-in) (SDHC) External storage: 1 x microSD card slot (SDHC)
■ Expansion	1 x Full-size mPCIe slot (USB2.0 signal only)

### I/O Interfaces

■ Isolated Serial Ports	1 x RS485, terminal block, auto direction control, 300~115.2k bps 1 x RS422/485, terminal block, auto direction control (RS-485), 300~115.2k bps 1 x RS232, DB9, auto flow control 300~115.2k bps
■ CAN	CANbus, version 2.0A/B compliant (terminal block, 10k~500k bps)
■ LAN Ports	2 x RJ45, 10/100 Mbps
■ USB Ports	1 x USB 2.0
■ Power Connector	1 x 4 Pin, Terminal Block , supports dual power input
■ Grounding Protection	Chassis Grounding
■ SIM	1 x Micro SIM card slot

### Environment

■ Operating Temperature	- 20 ~ 60°C (-4 ~ 140°F) @ 5 ~ 85% RH
■ Storage Temperature	- 40 ~ 85°C ( -40 ~ 185°F)
■ Relative Humidity	10 ~ 95% RH @ 40°C, non-condensing

- Shock Protection Operating, IEC 60068-2-27, 50G, half sine, 11ms
- Vibration Protection Operating, IEC 60068-2-64, 3 Grms, random, 5 ~ 500Hz, 1 hr/axis

## 1.3 Safety Precautions

The following sections tell how to make each connection. In most cases, you will simply need to connect a standard cable.

**Warning!** *Always disconnect the power cord from your chassis whenever you are working on it. Do not connect while the power is on. A sudden rush of power can damage sensitive electronic components. Only experienced electronics personnel should open the chassis.*



**Warning!** *Toujours à la terre pour éliminer toute charge d'électricité statique avant toucher UNO-1251G. Appareils électroniques modernes sont très sensibles à charges d'électricité statique. Utilisez un bracelet antistatique à tout moment. Placez tous composants électroniques sur une surface antistatique ou dans un statique-sac blindé.*



**Caution!** *Always ground yourself to remove any static electric charge before touching the product. Modern electronic devices are very sensitive to static electric charges. Use a grounding wrist strap at all times. Place all electronic components on a static-dissipative surface or in an anti-static bag.*



**Caution!** *Toujours débrancher le cordon d'alimentation de votre boîtier lorsque vous êtes travailler. Ne branchez pas lorsque l'appareil est allumé. Un afflux soudain de puissance peut endommager les composants électroniques sensibles. Seulement connu personnel de l'électronique devraient ouvrir le châssis.*



---

## 1.4 Accessories

Please refer below for the accessory list:

- 4-pin phoenix connector for power wiring (Advantech P/N: 1652000292)
- 10-pin phoenix connector for COM1/COM2/Console port (Advantech P/N: 1652005896)
- 3-pin phoenix connector for CAN port (Advantech P/N: 1652000049)
- Din-Rail Mounting kit (Advantech P/N: 1960018849T021)
- 3 x screws for Din-Rail kit (Advantech P/N: 1930000686)
- 1 x screws for mPCIe card (Advantech P/N: 1935020300)
- Warranty card

If anything is missing or damaged, contact your distributor or sales representative immediately.

# Chapter 2

## Hardware Functionality

This chapter shows the UNO-1251G's hardware functions, including:

- Introduction
- Serial connections
- Ethernet LAN Connector
- LED Indicators
- OLED indicators
- Power connector
- USB connector
- CAN port
- Reset Button
- Antenna Mounting
- microSD card slot
- micro SIM card slot
- PCI Express Mini card socket

## 2.1 Introduction

The following figures show the panel configuration on UNO-1251G. More information of each peripheral is included in the following sections.

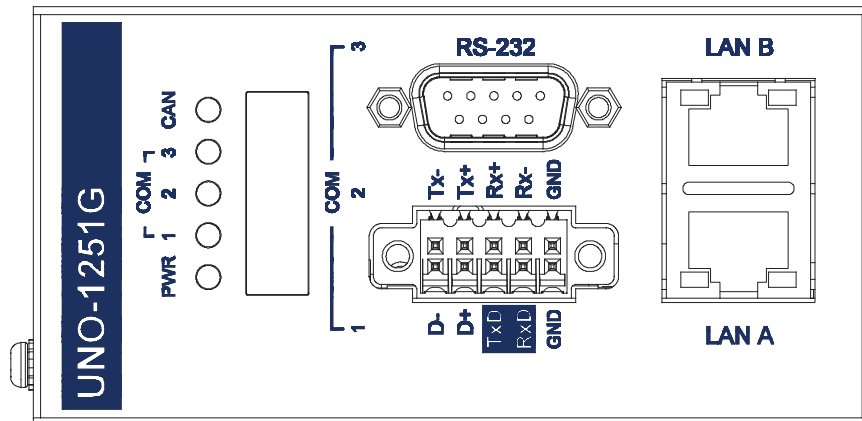

Figure 2.1 Front Panel of UNO-1251G

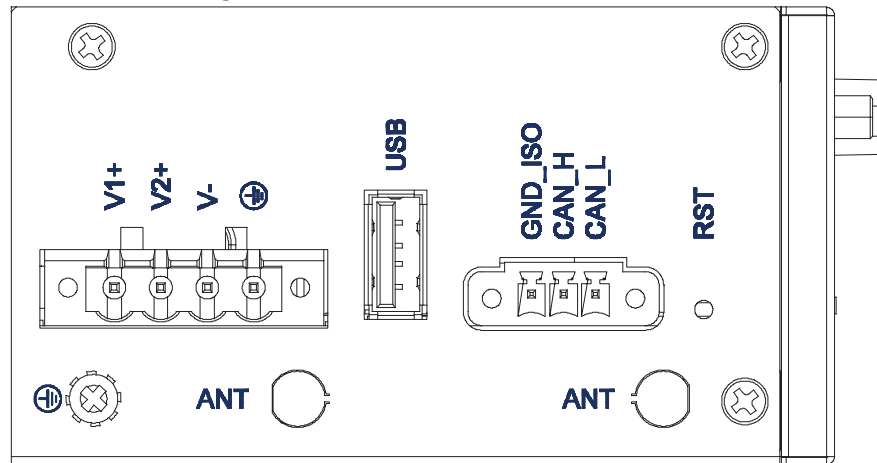

Figure 2.2 Top Panel of UNO-1251G

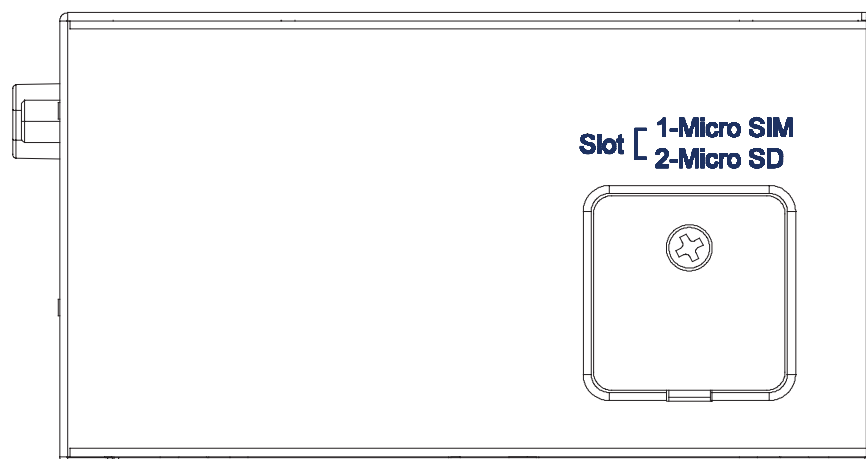

Figure 2.3 Bottom Panel of UNO-1251G



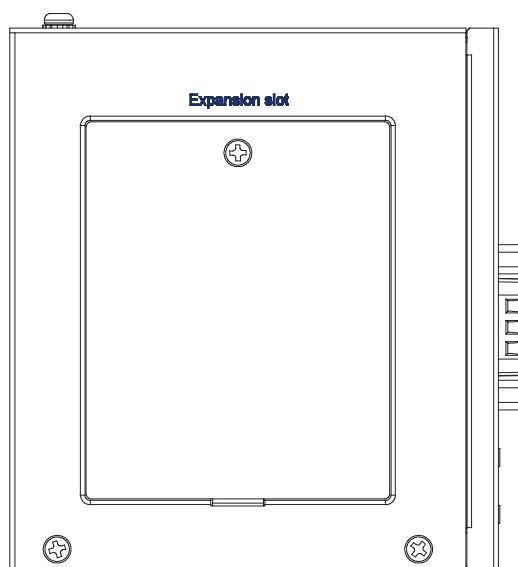
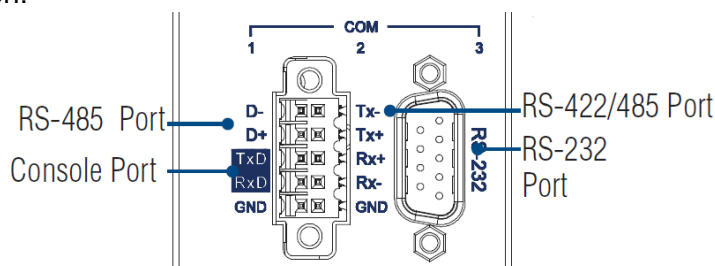

Figure 2.4 Left Panel of UNO-1251G

## 2.2 Serial Connections

### 2.2.1 Serial Mode and Terminator Resistor Selection

UNO-1251G provides 3 serial Com ports, COM1 provide RS-485, COM2 provides RS-422/485 and COM3 provides RS-232. The default setting of COM2 is RS-422. Users could change COM2 Port serial types to RS-422 or RS-485 by SW7 DIP switch selection.



The RS-422/485 terminator resistor is default enabled to match impedance. Especially in fields with electric noise, enabling terminal resistors is helpful to stabilize communications. Users could change COM2 serial port type and RS-422/485 terminator resistor settings by SW7/Serial Port Setting DIP switch located inside of the expansion slot on the left side of the UNO- 1251G system. Refer to Appendix A for their pin assignments and switch setting.

## 2.2.2 Debug Port

Debug port is reserved for engineers to proceed debug and / or console access.

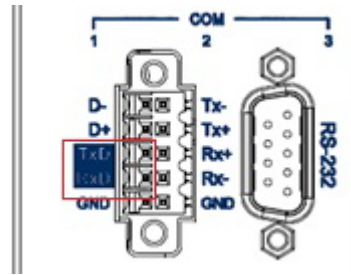

## 2.3 Ethernet LAN Connector

The UNO-1251G is equipped with two 10/100MB LAN controllers. The controllers can interface to UTP3,4,5 in 10Base-T and UTP5 in 100Base-TX with HP Auto-MDIX. Those are fully compliant with the IEEE 802.3u Spec. The Ethernet port provides a standard RJ-45 jack on board, and LED indicators on the front side to show its Link (Orange LED) and Active (Green LED) status. The default IP Address of LAN A is 10.0.0.1 and LAN B is 10.0.0.2.

## 2.4 LED Indicators

There are four LEDs indicating the status of the system power, serial and CAN are located on the front panel of UNO-1251G, and each of them has its own specific meaning, as shown in the table below.

- PWR: Green light means normal
- COM1~3: Flashing green means COM 1, COM2 and COM3 signals are being transmitted and received.
- CAN: Flashing green means CAN signals are being transmitted and received.

## 2.5 OLED Indicators

The UNO-1251G also has a built in programmable OLED display which provides an intuitive way for diagnosing the system status through the displayed messages. It comes with a range of default messages, but is also able to be programmed, using the OLED Display API.

## 2.6 Power Connector

The UNO-1251G comes with a Phoenix connector that carries 10~36 VDC external power input, and features reversed wiring protection. Therefore, it will not cause any damage to the system by reversed wiring of ground line or power line. In the power connector, there is a secondary power input that helps users plug-in a second power source to prevent main power source failure.

The UNO-1251G supports AT-type for system booting up. The system will automatically boot up once the power is connected.

## 2.7 USB Connector

The USB interface supports Plug and Play, which enables you to connect or disconnect a device whenever you want, without turning off the computer. The UNO-1251G provides one connector of USB interfaces, which gives complete Plug & Play and hot swapping for up to 127 external devices. The USB interface complies with USB EHCI, Rev. 2.0 compliant.

## 2.8 CAN Port

UNO-1251G provides one CAN port which is version 2.0A/B compliant.

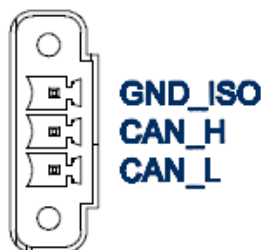

## 2.9 Reset Button

Press the “RST” button to activate the hardware reset function. The system reset button is on the top panel shown in Figure 2.2.

## 2.10 Antenna Mounting

The UNO-1251G provides two antenna mounting holes with pre-cut cover that allows users to install antenna kit for Wi-Fi, GPRS/3G or other wireless functions. The two antenna mounting holes are on the top panel shown in Figure 2.2.

## 2.11 microSD card Slot

UNO-1251G provides one board microSD slot for OS and one externally accessible microSD slot for data storage. It is fully compliant with SD command / response sets as defined in the SD Memory Card Specifications, V2.0 including high capacity SDHC cards up to 32GB. User can insert microSD card from the bottom panel shown in Figure 2.3.



---

## 2.12 Micro SIM card Slot

There is one externally accessible micro SIM card slot on UNO-1251G. User can insert standard micro-SIM card from the bottom panel shown in Figure 2.3.

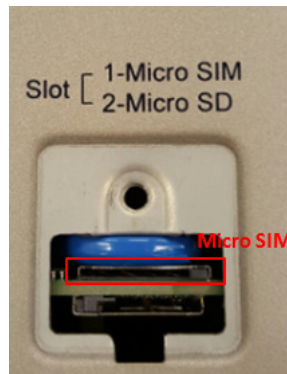

## 2.13 PCI Express Mini Card Socket

The UNO-1251G supports one full-size PCI Express Mini (mPCIe) card expansion, refer to Figure 2.4. The mPCIe slot only provides USB signal and connecting with SIM card slot.

# Chapter 3

## Initial Setup

This chapter introduces how to initialize the UNO-1251G.

Sections include:

- Chassis Grounding
- Inserting a microSD/SIM card
- Installing a wireless module card and antenna
- Installing iDoor expansion I/O
- Din-rail kit assembly
- Connecting Power
- Remote Access

## 3.1 Chassis Grounding

The UNO-1251G is designed with EMI protection and a stable grounding base. There is an easy-to-connect chassis grounding point to use. Note that the system ground and chassis ground are separate.

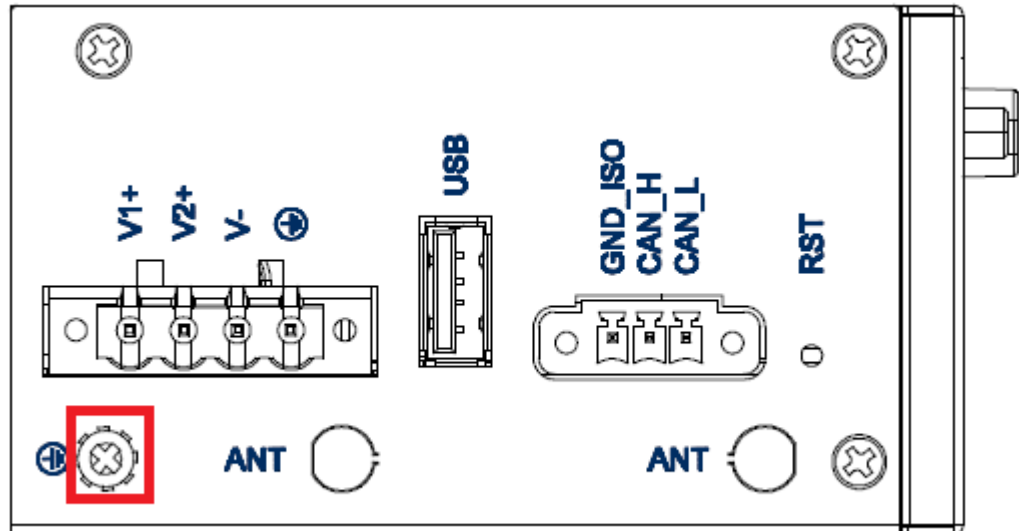

Figure 3.1 Chassis Grounding Connection

## 3.2 Inserting a microSD card/microSIM card (Optional)

The UNO-1251G provides one externally accessible micro SD card slot (for storage) and one micro SIM card slot. Users can insert the cards using the following steps.

1. Remove the power cable.
2. Unscrew the microSD/microSIM card lid on the bottom panel.
3. Insert the microSD card or Micro-SIM card into the slots.
4. Screw back the lid.

### 3.3 Installing a Wireless module Card and Antenna (Optional)

For optional wireless module card and antenna, please contact Advantech for the following wireless solution kit.

- Top panel with pre-cut antenna holes

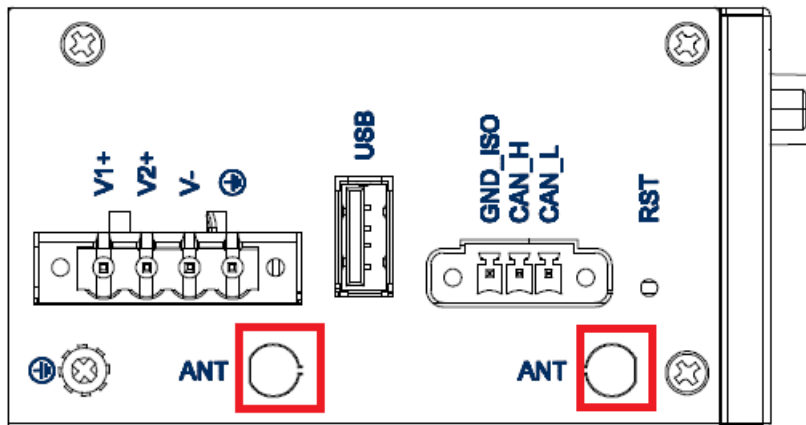

- The internal coaxial cable with standard SMA connector

For more information about internal coaxial cable, please contact with Advantech.



- Wireless module card (PCI Express Mini card)

The UNO-1251G supports one full-size mPCIe slot (only USB signal) for wireless module card installation. For more information about wireless module cards, refer to the datasheet or contact Advantech.

■ Antenna

Select the necessary specification according to your application. For more information about antenna, please contact with Advantech.

Then follow the below steps for the installation:

1. Unscrew the lid of the left hand side expansion slot and open it.
2. Remove the pre-cut cover on antenna hole(s) on the top panel for antenna installation.
3. Install the internal coaxial cable(s) through the antenna hole(s).
4. Insert the wireless module card into the PCI Express mini card socket and screw it.
5. Connect the internal coaxial cable(s) with the wireless module card.
6. Screw back the chassis.
7. Assemble the antenna(s) on the SMA connector.

### 3.4 Din-rail Kit Assembly

The UNO-1251G supports Din-rail mounting. The Din-rail kit and screws are included in the accessory bag. The assembly instruction is shown in Figure 3.2 below.

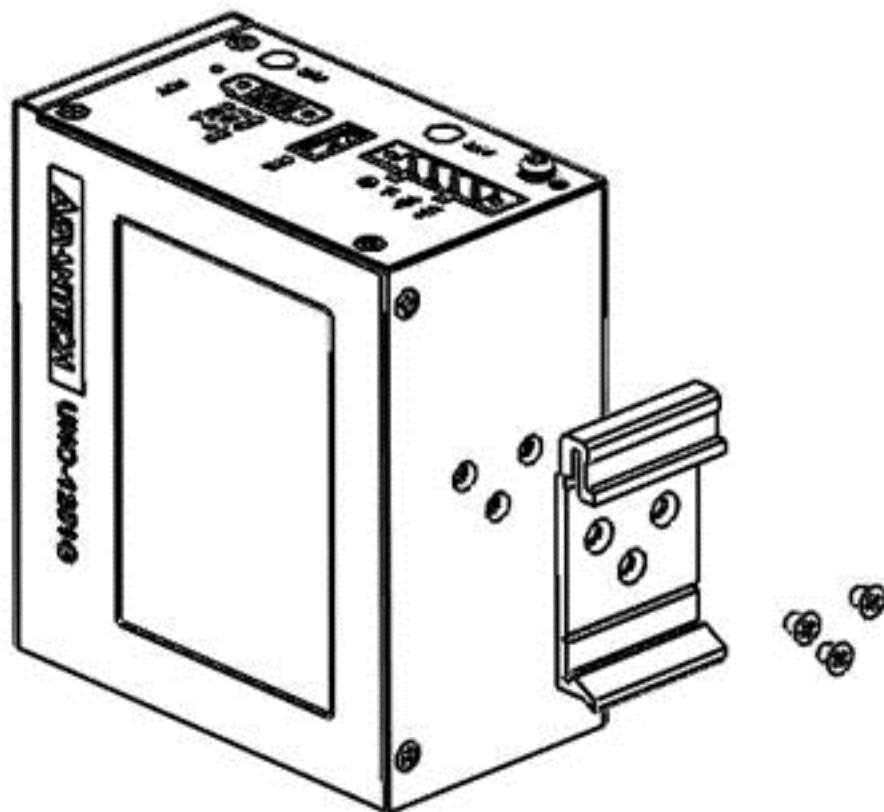
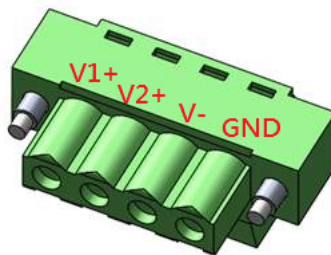

Figure 3.2 UNO-1251G with Din-rail mounting



## 3.5 Connecting Power

Connect the UNO-1251G to a 10~36 V<sub>DC</sub> power source. The power source can either be from a listed power adapter or DC power source.



## 3.6 Remote Access

### ■ WEC7 version

The UNO-1251G can be remotely accessed by VNC client. You can use the VNC tool, which supports 16 bit pixel size setting, to remotely access the UNO-1251G.

Here is example using “.NET VNC Viewer” as VNC client.

1. Set the IP address of PC (VNC client) to be the same domain as UNO-1251G. (10.0.0.X. X could be any digit excludes 1 & 2)

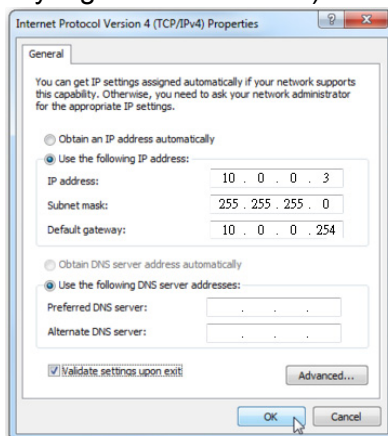

2. Download “.NET VNC Viewer” & execute it in PC (VNC client) (<http://dotnet-vnc.sourceforge.net/>)
3. Key in IP address of UNO-1251G in "Server" column. (Default IP address of LAN A is 10.0.0.1 & LAN B is 10.0.0.2. Port is 5900.)

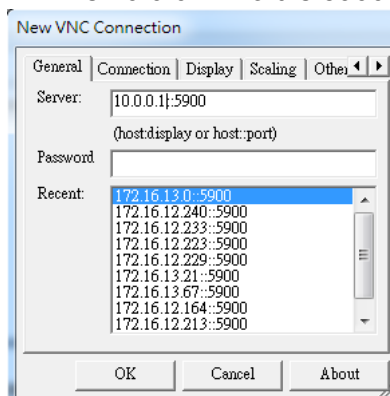

4. Set "Pixel size" to be "Server decides" in "Display" tab.

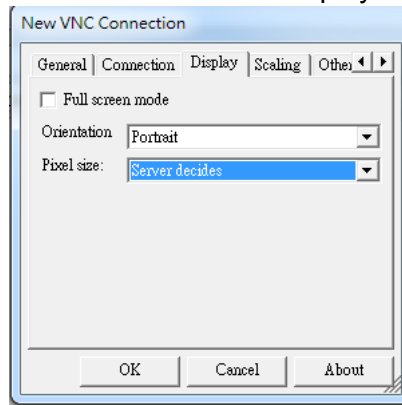

5. Press "OK"

- Embedded Linux version

The UNO-1251G installed with embedded Linux could be also accessed by VNC client. The VNC tool could be ".NET VNC Viewer" or other VNC viewers. E.g. RealVNC viewer, TightVNC viewer and UltraVNC viewer, etc.

# Appendix **A**

System Settings and  
Pin Assignments

## A.1 Board Connectors and Switches

There are several connectors and jumpers on the UNO-1251G board. The following sections tell you how to configure the UNO-1251G hardware setting.

Figure A.1 shows the locations of UNO-1251G's connectors and switches.

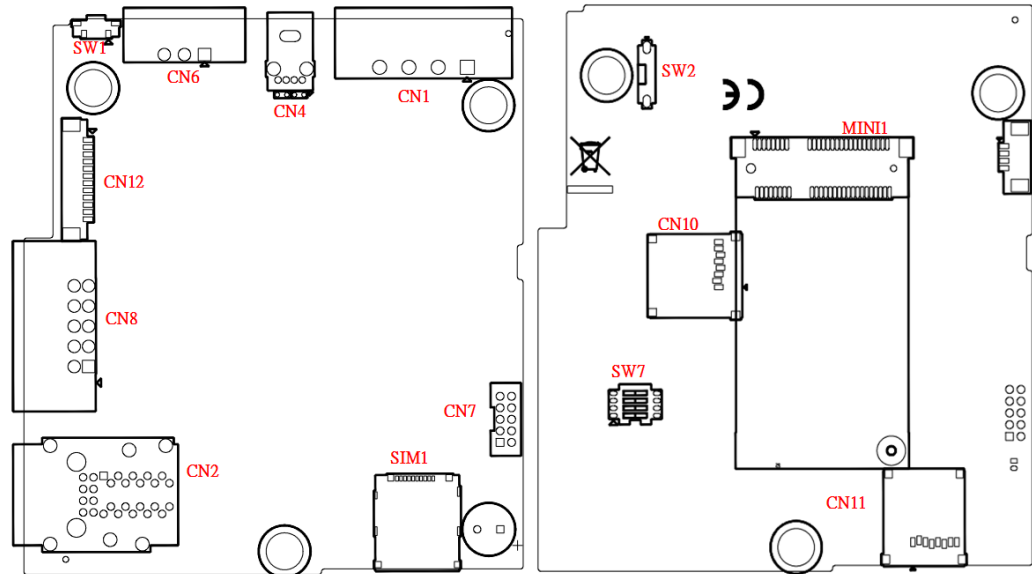
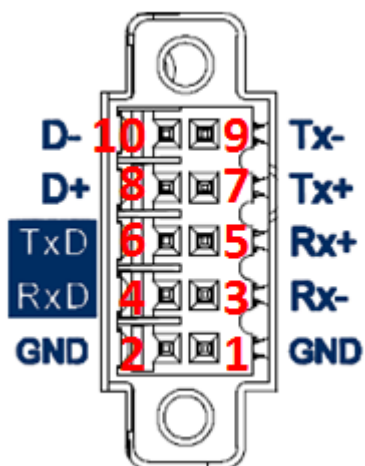

Figure A.1 Connector & Switch Locations (front)

Table A.1: Connectors and Jumpers

Label	Function
CN10	Micro SD card (OS image)
CN11	Micro SD card (External Storage)
MINI1	mPCIe slot with USB & SIM signal
SW7	Switch for COM2 RS-232/485, COM1/2 terminal resistance
SW2	Switch for CAN terminal resistance
SIM1	Micro SIM card slot for MINI1

## A.2 RS-485 Serial Port (COM1), RS-422/485 Serial Port (COM2) and console port



**Table A.2: Connectors and Jumpers**

Pin	Description
1	GND
2	GND
3	COM2 RS-422 Rx
4	Debug port Rx
5	COM2 RS-422 Rx+
6	Debug port Tx
7	COM2 RS-422 Tx+ or RS-485 Data+
8	COM1 RS-485 Data+
9	COM2 RS-422 Tx- or RS-485 Data-
10	COM1 RS-485 Data-

## A.3 Switch setting of RS-485 Serial Port (COM1) & RS-422/485 Serial Port (COM2)

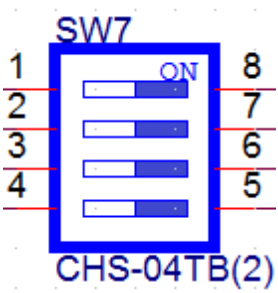
SW	SW7	
Description	COM1 RS485; COM2 RS422/485 termination resistor setting COM2 RS422/485 mode setting	
Default	1. Termination resistor ON 2. COM2 RS-422 mode (contact to Pin 5, 6, 7, 8)	
Termination resistor ON	COM1 RS485: Contact to Pin 8, COM2 RS485: Contact to Pin 7, COM2 RS422 Tx: Contact to Pin 7, COM2 RS422 Rx: Contact to Pin 6 (if switch to termination resistor OFF, Contact to Pin 1, 2, 3)	
RS-422 master mode	Contact to Pin 5 (if switch to RS-422 slave mode/RS-485, contact to Pin4)	

## A.4 RS-232 Serial Port (COM3)

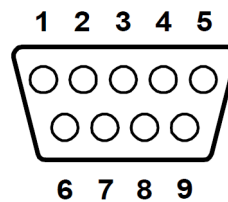

**Table A.3: Connectors and Jumpers**

Pin	Description
1	DCD
2	RxD
3	TxD
4	DTR
5	GND
6	DSR
7	RTS
8	CTS
9	RI

## A.5 CAN Port



**Table A.4: Connectors and Jumpers**

Pin	Description
1	GND
2	CAN_H
3	CAN_L

## A.6 Switch setting of CAN port

SW	SW2
Description	CAN termination resistor setting
Default	Termination resistor ON
Termination resistor ON	Contact to 2 (if switch to termination resistor OFF, Contact to Pin 1)
	<p>The diagram shows a switch labeled SW2, model ESD101E65Z. It has two terminals, 1 and 2. The switch is currently in the 'ON' position, connecting terminal 1 to terminal 2.</p>

## A.7 Power Connector

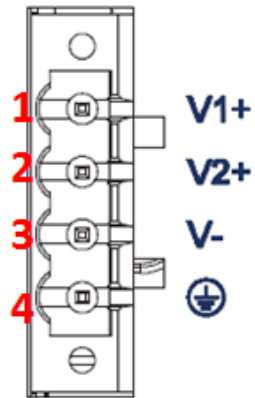

**Table A.5: Connectors and Jumpers**

Pin	Description
1	10~36 V+DC Input 1
2	10~36 V+DC Input 2
3	Power ground
4	Chassis ground

## A.8 USB Connector

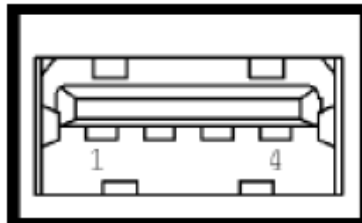
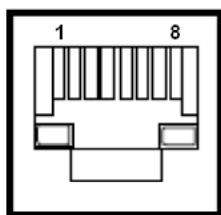

**Table A.6: Connectors and Pin Assignments**

Pin	Signal Name	Description
1	VCC	Red
2	DATA-	White
3	DATA+	Green
4	GND	Black



## A.9 LAN Connector



**Table A.7: Connectors and Pin Assignments**

Pin	Signal Name
1	XMT+
2	XMT-
3	RCV+
4	NC
5	NC
6	RCV-
7	NC
8	NC

## [www.advantech.com](http://www.advantech.com)

Please verify specifications before quoting. This guide is intended for reference purposes only.

All product specifications are subject to change without notice.

No part of this publication may be reproduced in any form or by any means, electronic, photocopying, recording or otherwise, without prior written permission of the publisher.

All brand and product names are trademarks or registered trademarks of their respective companies.

© Advantech Co., Ltd. 2016