

User Manual

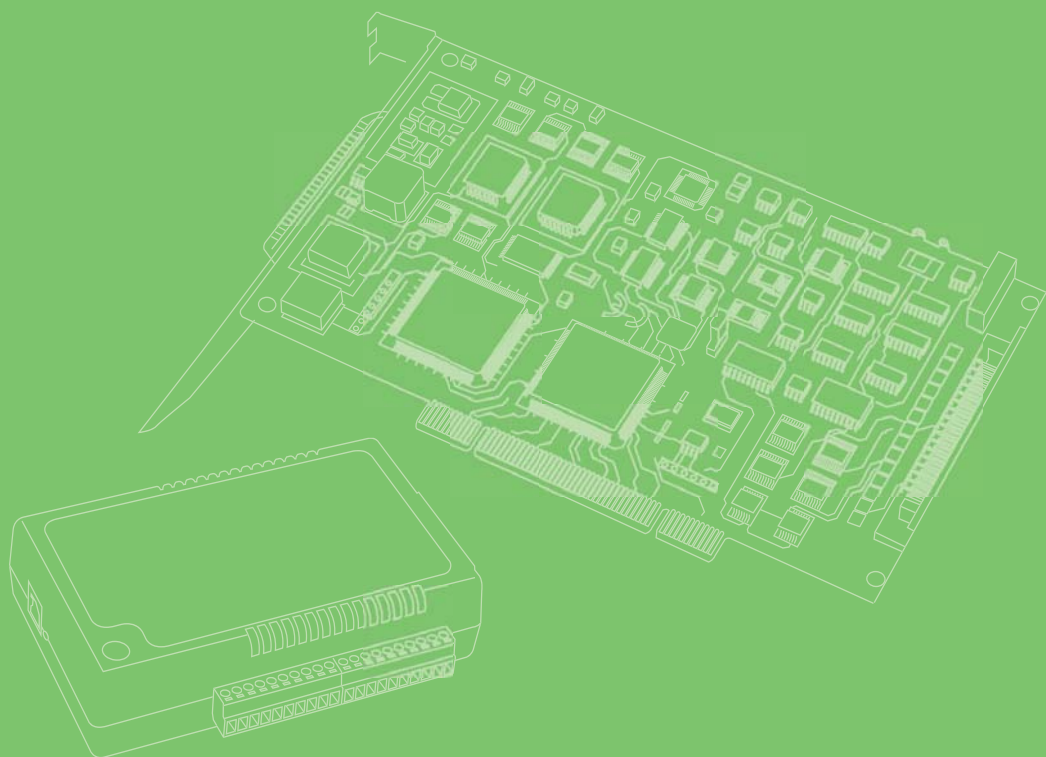

PCI COMM Series User Manual

Industrial Serial Communication
Cards

ADVANTECH

Enabling an Intelligent Planet

Copyright

The documentation and software included with this product are copyrighted 2018 to Advantech Co., Ltd. All rights are reserved. Advantech Co., Ltd. reserves the right to make improvements on the products described in this manual at any time without notice. No part of this manual may be reproduced, copied, translated, or transmitted in any form or by any means without prior written permission from Advantech Co., Ltd. The information provided in this manual is intended to be accurate and reliable. However, Advantech Co., Ltd. assumes no responsibility for its use, nor for any infringements of the rights of third parties, which may result from its use.

Acknowledgments

Intel® and Pentium® are trademarks of Intel Corporation.

Microsoft Windows and MS-DOS are registered trademarks of Microsoft Corporation.

All other product names or trademarks are the property of their respective owners.

Product Warranty (5 years)

Advantech warrants to you, the original purchaser, that this product will be free from defects in materials and workmanship for 5 years from the date of purchase.

This warranty does not apply to products that have been repaired or altered by persons other than repair personnel authorized by Advantech, nor does it apply to products that have been subject to misuse, abuse, accident, or improper installation. Under the terms of this warranty, Advantech assumes no liability for consequences arising from such events.

Because of Advantech's high quality-control standards and rigorous testing, most of our customers never need to use our repair service. If an Advantech product is defective, it will be repaired or replaced at no charge during the warranty period. For out-of-warranty repairs, you will be billed according to the cost of replacement materials, service time, and freight. Please consult your dealer for more details.

If you believe that you have a defective product, follow these steps:

1. Collect all the information about the problem encountered (e.g., CPU speed, Advantech products used, other hardware and software used, etc.). Note anything abnormal and list any on-screen messages that appear when the problem occurs.
2. Call your dealer and describe the problem. Please have your manual, product, and any helpful information readily available.
3. If your product is diagnosed as defective, obtain a return merchandise authorization (RMA) number from your dealer. This allows us to process your return more quickly.
4. Carefully pack the defective product, a fully completed Repair and Replacement Order Card, and proof of purchase date (e.g., a photocopy of your sales receipt) in a shippable container. A product returned without proof of the purchase date is not eligible for warranty service.
5. Write the RMA number clearly on the outside of the package and ship it prepaid to your dealer.

Part No. 2003160004

Printed in Taiwan

Edition 5

January 2018

Declaration of Conformity

CE

This product has passed the CE test for environmental specifications. Test conditions for passing include the equipment being operated within an industrial enclosure. To protect the product from damage due to electrostatic discharge and EMI leakage, we strongly recommend using CE-compliant industrial enclosure products.

FCC Class A

This equipment has been tested and found to comply with the limits for a Class A digital device, pursuant to Part 15 of the FCC rules. These limits are designed to provide reasonable protection against harmful interference when the equipment is operated in a commercial environment. This equipment generates, uses, and can radiate radio-frequency energy and, if not installed and used in accordance with the instruction manual, may cause harmful interference to radio communications. Operation of this equipment in a residential area is likely to cause harmful interference in which case the user will be required to correct the interference at his or her own expense.

Technical Support and Assistance

1. Visit the Advantech website at www.advantech.com/support for the latest information about this product.
2. Should you require additional assistance, contact your distributor, sales representative, or Advantech's customer service center for technical support. Please have the following information ready before you call:
 - Product name and serial number
 - Description of your peripheral attachments
 - Description of your software (OS, version, application software, etc.)
 - A complete description of the problem
 - The exact wording of any error messages

Warnings, Cautions, and Notes

Warning! Warnings indicate conditions, which if not observed, can cause personal injury!



Caution! Cautions are included to help you avoid damaging hardware or losing data.



Note! Notes provide optional additional information.



Document Feedback

To assist us in improving this manual, we welcome your feedback. Please write to support@advantech.com.

Packing List

Before setting up the system, you should check that the items listed below are included and in good condition. Please contact your dealer immediately if there is some discrepancy.

- PCI communication interface board
- Industrial communication driver, utility, and user manual (CD-ROM)

Safety Instructions

1. Read these safety instructions carefully.
2. Retain the user manual for later reference.
3. Disconnect the equipment from any AC outlet before cleaning. Use a damp cloth. Do not use liquid or spray detergents.
4. For plug-in equipment, the power outlet socket must be located near the equipment and be easily accessible.
5. Keep the equipment away from humidity.
6. Place the equipment on a stable surface during installation. Dropping it or letting it fall may cause damage.
7. The openings on the enclosure are for air convection. Protect the equipment from overheating. Do not cover the openings.
8. Ensure that the power source voltage is correct before connecting the equipment to a power outlet.
9. Position the power cord so that people cannot step on it. Do not place anything over the power cord.
10. Pay attention to any cautions and warnings noted on the equipment.
11. If the equipment is not used for a long time, disconnect it from the power source to prevent damage from transient overvoltage.
12. Never pour any liquid into the openings. This may cause fire or electrical shock.
13. Never open the equipment. For safety reasons, the equipment should be opened only by qualified service personnel.
14. If one of the following situations arises, get the equipment checked by service personnel:
 - The power cord or plug is damaged.
 - Liquid has penetrated the equipment.
 - The equipment has been exposed to moisture.
 - The equipment does not work well, or you cannot get it to work according to the user manual.
 - The equipment has been dropped and damaged.
 - The equipment has obvious signs of breakage.
15. Do not store this equipment in an environment where the temperature may go below -20°C (-4°F) or above 60°C (140°F). This could damage the equipment. The equipment should be kept in a controlled environment.
16. **CAUTION:** The battery may explode if it is incorrectly replaced. Replace only with the same or equivalent type recommended by the manufacturer, and discard used batteries in accordance with the manufacturer's instructions.
17. In accordance with IEC 704-1:1982, the sound pressure level at the operator's position does not exceed 70 dB (A).

DISCLAIMER: These instructions are given in accordance with IEC 704-1. Advantech disclaims all responsibility for the accuracy of any statements contained herein.

Safety Precaution - Static Electricity

Follow these simple precautions to protect yourself from harm and to protect the equipment from damage:

- To avoid electrical shock, always disconnect the power from your PC chassis before you work on it. Do not touch any components on the CPU card or other cards while the PC is on.
- Disconnect the power before making any configuration changes. A power spike as you connect a jumper or install a card may damage sensitive electronic components.

Contents

Chapter 1	Introduction.....	1
1.1	Description	2
1.1.1	PCI Bus.....	2
1.2	Features	2
1.3	Specifications	3
1.3.1	Bus Interface.....	3
	Table 1.1: Transmission Modes	3
	Table 1.2: Power Consumption	4
1.3.2	Ordering Information	5
	Table 1.3: Model List	5
	Table 1.4: PCI Communication Card Selection Guide	5
Chapter 2	Hardware Configuration.....	7
2.1	Initial Inspection	8
2.2	Jumper and Switch Locations	9
2.2.1	PCI-1602B	9
	Figure 2.1 PCI-1602B Silk Screen.....	9
2.2.2	PCI-1602C/PCI-1604C	9
	Figure 2.2 PCI-1602C/1604C Silk Screen	9
2.2.3	PCI-1602UP.....	10
	Figure 2.3 PCI-1602UP Silk Screen	10
2.2.4	PCI-1612B/PCI-1610B.....	10
	Figure 2.4 PCI-1612B/1610B Silk Screen	10
2.2.5	PCI-1612C/PCI-1610C	11
	Figure 2.5 PCI-1612C/1610C Silk Screen.....	11
2.2.6	PCI-1622B/PCI-1620A/PCI-1620B	11
	Figure 2.6 PCI-1622B/PCI-1620A/PCI-1620B Silk Screen.....	11
2.2.7	PCI-1622C	12
	Figure 2.7 PCI-1622C Silk Screen.....	12
2.3	Jumper Settings	13
2.3.1	How to Set Jumpers.....	13
	Figure 2.8 How to Set Jumpers	13
2.3.2	Default Settings.....	13
2.3.3	Mode Selection by Jumper/DIP Settings	14
	Figure 2.9 PCI-1600 Series RS-232/422/485 Selection	14
	Table 2.1: PCI-1600 Series Operating Mode Jump Position.....	14
	Table 2.2: Board ID Setting	14
	Table 2.3: TX Enable Mode Selection	15
	Figure 2.10 Impedance Selection (for PCI-1600 Series)	16
	Table 2.4: PCI-1600 Series Impedance Selection Jumper Position	16
2.4	Card Installation	17
Chapter 3	Driver Setup and Installation.....	19
3.1	Introduction	20
3.2	Driver Setup	20
3.2.1	Operating System Driver Setup	20
3.3	Driver Uninstall.....	23

Appendix 4 ICOM Tools 25

4.1	Introduction	26
4.2	Installation.....	26
4.3	ICOM Tools User Interface	26
4.3.1	Menu Bar	26
4.3.2	Tool Bar	27
4.3.3	Com Port Tab	28
4.3.4	Port Status	28
4.3.5	Message Logo	29
4.3.6	TX Slide Bar.....	29
4.3.7	Performance Listing Area	29
4.3.8	Status Bar	30
4.4	Using the ICOM Tools Utility	30
4.4.1	Port Selection	30
	Figure 4.1 ICOM Tools Program Window.....	30
	Figure 4.2 Select Port Dialog Box	30
	Figure 4.3 Ports Selected Appear in the Selected Ports Field ..	31
	Figure 4.4 ICOM Tools User Interface.....	31
4.4.2	Configuring a Port.....	32
	Figure 4.5 Test Information on the Performance Listing Area ...	32
	Figure 4.6 Test Information on the Performance Listing Area ...	33
4.4.3	Close Port.....	33
4.4.4	Exit the ICOM Tools Utility.....	33
4.5	Messages on Status Bar and Message Logo Area.....	33
4.5.1	Status Bar Messages.....	34
4.5.2	Message Logo Messages.....	34

Appendix 5 Pin Assignments and Wiring 35

5.1	Pin Assignments	36
5.1.1	PCI-1602B/C/UP.....	36
	Table 5.1: PCI-1602B/C Male DB9 on Bracket	36
5.1.2	PCI-1604B/C.....	36
	Table 5.2: PCI-1604C Male DB9 on Bracket.....	36
5.1.3	PCI-1610B/C.....	37
	Table 5.3: PCI-1610B/C Male DB9 on Cable	37
	Table 5.4: PCI-1610B/C Male DB25 on Cable	37
	Table 5.5: PCI-1610B/C Female DB37 on Bracket	38
5.1.4	PCI-1612B/C.....	39
	Table 5.6: PCI-1612B/C Male DB9 on Cable	39
	Table 5.7: PCI-1612B/C Male DB25 on Cable	39
	Table 5.8: PCI-1612B/C Female DB37 on Bracket	40
5.1.5	PCI-1620A, PCI-1620B and PCI-1622B	41
	Table 5.9: PCI-1620A, PCI-1620B and PCI-1622B Female DB62 on Bracket	41
	Table 5.11: PCI-1620A and PCI-1620B Male DB9 on Cable	42
	Table 5.12: PCI-1622B Male DB25 on Cable.....	42
	Table 5.10: PCI-1622B Male DB9 on Cable.....	42
5.1.6	PCI-1622C	43
	Table 5.13: PCI-1622C Male DB9 on Cable	43
	Table 5.14: PCI-1622C Female DB78 on Bracket	44
5.2	Wiring.....	45
5.2.1	RS-232 Signal Wiring	45
	Table 5.15: Terminal or PC (DTE) Connections.....	45
	Table 5.16: Modem Connections	45
	Table 5.17: Terminal Without Handshake	46
5.2.2	RS-422 Signal Wiring	46
	Table 5.18: RS-422 DB9 Pin Assignment	46

5.2.3	RS-485 Signal Wiring.....	47
	Figure 5.1 RS-485 Wiring Topology	47

Appendix A **Scale of Connectors49**

A.1	Connector Size Comparison	50
	Figure A.1 DB9 Male.....	50
	Figure A.2 DB25 Male.....	50
	Figure A.3 DB37 Female.....	50
	Figure A.4 DB62 Female.....	51
	Figure A.5 DB78 Female.....	51

Chapter 1

Introduction

1.1 Description

1.1.1 PCI Bus

The PCI Bus is a high-performance bus that provides a processor-independent data path between the CPU and high-speed peripherals. PCI is a robust interconnect mechanism designed specifically to accommodate multiple high-performance peripherals for serial communication, SCSI, LAN, and so on.

Advantech's serial communication card leverages the "Plug & Play" capability defined in the PCI 2.1/2.2 bus specification. The board requires only one PCI slot and provides independent serial channels. All channels are addressed in a continuous 32-byte I/O block for simplified software access. Furthermore, all channels may share one PCI interrupt. An interrupt status register is available for determining the interrupt source.

The Advantech PCI communication card applies the RE-232/422/485 standard, which provides deeper FIFOs compared to serial ports. These upgraded FIFOs greatly reduce the CPU overhead and are ideal for heavy multitasking environments.

1.2 Features

PCI Card Features

- PCI Specification 2.1/2.2 compliant
- Speeds of up to 921.6 Kbps for extremely fast data transmission
- Supports any baud rate
- 2 x RS-232 or RS- 232/422/485 ports/ XR17V352 UART with 256-byte FIFOs
- 4 x RS-232 or RS- 232/422/485 ports/ XR17V354 UART with 256-byte FIFOs
- 8 x RS-232 or RS- 232/422/485 ports/ XR17V358 UART with 256-byte FIFOs
- OS support: Windows XP/7/8/10 and Linux (refer to the software release note for information on the supported OS versions)
- Utility-ICOM tools

1.3 Specifications

1.3.1 Bus Interface

The following table shows the bus specifications of the comm. cards.

■ Bus Interface	■ Models
PCI Bus Specifications 2.2	PCI-1602B, PCI-1602C, PCI-1602UP, PCI-1604C, PCI-1610B, PCI-1610C, PCI-1612B, PCI-1612C, PCI-1620A, PCI-1620B, PCI-1622B, PCI-1622C

- **IRQ:** All ports use the same IRQ assigned by PCI Plug-and-Play
- **Data bits:** 5, 6, 7, 8
- **Stop bits:** 1, 1.5, 2
- **Parity:** None, Even, Odd, Mark, and Space
- **Speed (bps):**

Model	Criteria	Speed (bps)
PCI Series	A level	50~921.6 kbps
	B level	50~921.6 kbps

- **Data Signals:**

Table 1.1: Transmission Modes

BUS Interface	Model Name	Ports	Communication Interface		
			RS-232	RS-422	RS-485
PCI	PCI-1602B	2	V	V	V
	PCI-1602C	2	V	V	V
	PCI-1602UP	2	V	V	V
	PCI-1604B	2	V		
	PCI-1604C	2	V		
	PCI-1610B	4	V		
	PCI-1612B	4	V	V	V
	PCI-1612C	4	V	V	V
	PCI-1610C	4	V		
	PCI-1620A	8	V		
	PCI-1620B	8	V		
	PCI-1622B	8	V	V	V
	PCI-1622C	8	V	V	V

1. RS-232: TxD, RxD, RTS, CTS, DTR, DSR, DCD, RI
2. RS-422: Tx+, Tx-, Rx+, Rx-, CTS+, CTS-, RTS+, RTS-
3. RS-485: Data+, Data-

- **Dimensions**

Size	Model
119.91 x 106.67 mm (4.72" x 4.2")	PCI-1602B, PCI-1602C, PCI-1604C
174.65 x 106.67 mm (6.88" x 4.2")	PCI-1610B, PCI-1610C, PCI-1612B, PCI-1612C, PCI-1620A, PCI-1620B, PCI-1622B, PCI-1622C
119.91 x 64.41 mm (4.7" x 2.5") (low-profile MD1)	PCI-1602UP

- **Power Consumption**

Table 1.2: Power Consumption

Model Name	Typical	Maximum
PCI-1602B	260 mA @ +3.3 V	330 mA @ +3.3 V
PCI-1602C	260 mA @ +3.3 V	450 mA @ +3.3 V
PCI-1602UP	260 mA @ +3.3 V	420 mA @ +3.3 V
PCI-1604C	260 mA @ +3.3 V	450 mA @ +3.3 V
PCI-1610B	260 mA @ +3.3 V	530 mA @ +3.3 V
PCI-1610C	260 mA @ +3.3 V	680 mA @ +3.3 V
PCI-1612B	260 mA @ +3.3 V	530 mA @ +3.3 V
PCI-1612C	260 mA @ +3.3 V	680 mA @ +3.3 V
PCI-1620A	260 mA @ +3.3 V	880 mA @ +3.3 V
PCI-1620B	260 mA @ +3.3 V	880 mA @ +3.3 V
PCI-1622B	260 mA @ +3.3 V	880 mA @ +3.3 V
PCI-1622C	260 mA @ +3.3 V	1250 mA @ +3.3 V

- **Operating Temperature:** -10~60°C (14~144°F)
- **Operating Humidity:** 5~95% relative humidity, non-condensing
- **Storage Temperature:** -25~85°C (-13~185°F)
- **Current Value:** 20 mA (standard)
- **Mode:**
RS-232/422: Asynchronous, full duplex
RS-485: Asynchronous, half duplex
- **Baud Rate:** 50~921.6 Kbps
- **Transmission Distance:**
RS-232 < 15 m
RS-422/485 < 1000 m

Note! PCI-1602UP uses PI7C8952 as the communication controller.



1.3.2 Ordering Information

Table 1.3: Model List

Product	Description
PCI-1602B	2-port RS-232/422/485 PCI comm. card w/surge protection
PCI-1602C	2-port RS-232/422/485 PCI comm. card w/surge and isolation protection
PCI-1602UP	2-port RS-232/422/485 low-profile PCI comm. Card w/surge and isolation protection
PCI-1604C	2-port RS-232 PCI comm. card w/surge and isolation protection
PCI-1610B	4-port RS-232 PCI comm. card w/surge protection
PCI-1610C	4-port RS-232 PCI comm. card w/surge and isolation protection
PCI-1612B	4-port RS-232/422/485 PCI comm. card w/surge protection
PCI-1612C	4-port RS-232/422/485 PCI comm. card w/surge and isolation protection
PCI-1620A	8-port RS-232 PCI comm. card
PCI-1620B	8-port RS-232 PCI comm. Card w/surge protection
PCI-1622B	8-port RS-232/422/485 PCI comm. card w/surge protection
PCI-1622C	8-port RS-232/422/485 PCI comm. card w/surge and isolation protection

Table 1.4: PCI Communication Card Selection Guide

Model		Ports	Comm. Interface Support	Protection	
				Surge	Isolation
PCI-1602	B	2	RS-232/422/485	1000 V	
	C		RS-232/422/485	1000 V	3000 V _{DC}
	UP		RS-232/422/485	1000V	3000 V _{DC}
PCI-1604	C		RS-232	1000 V	3000 V _{DC}
PCI-1610	B	4	RS-232	1000 V	
	C		RS-232	1000 V	3000 V _{DC}
PCI-1612	B		RS-232/422/485	1000 V	
	C		RS-232/422/485	1000 V	3000 V _{DC}
PCI-1620	A	8	RS-232		
	B		RS-232	1000 V	
PCI-1622	B		RS-232/422/485	1000 V	
	C		RS-232/422/485	1000 V	3000 V _{DC}

1.3.2.1 Accessories

- **OPT4A-AE:** 30-cm male DB-37 to 4 x male DB9 cables
- **OPT8C-AE:** 1-m male DB-62 to 8 x male DB-25 cables
- **OPT8H-AE:** 1-m male DB-62 to 8 x male DB-9 cables
- **OPT8J-AE:** 1-m male DB-78 to 8 x male DB-9 cables
- **OPT8HP:** 1-m double shield DB-62 to 8 x DB-9 cables
- **OPT8AP-AE:** 8-port RS-232(DCE) connection box w/(F) DB25 connector

Chapter 2

Hardware
Configuration

2.1 Initial Inspection

1. PCI comm. card
2. ICOM CD-ROM including:
 - a. User manual
 - b. Industrial communication driver
 - c. Utility tool

We carefully inspect our PCI communication cards mechanically and electrically before shipping. Your card should be free of marks and scratches and in perfect working condition upon receipt.

As you unpack, check for any signs of shipping damage (damaged box, scratches, dents, etc.). Should you find any damage or if the card fails to meet specifications, please notify our service department or your local sales representative immediately. The carrier should also be notified. Please retain the shipping carton and packing material for further inspections by the carrier.

After inspection we will arrange either repair or a replacement.

When you handle the card, hold the rear metal panel when removing it from its protective packaging. Keep the anti-vibration packaging for later storage should you need to remove the card from the PC.

Warning! *Discharge your body's static electric charge by touching the back of the grounded chassis of the system unit (metal) before handling the board. You should avoid contact with materials that hold a static charge such as plastic, vinyl, and styrofoam. Handle the board only by its edges to prevent static from damaging its integrated circuits. Avoid touching the exposed circuit connectors. We recommend that you use a grounded wrist strap and place the card on a static dissipative mat whenever you handle it.*



2.2 Jumper and Switch Locations

2.2.1 PCI-1602B

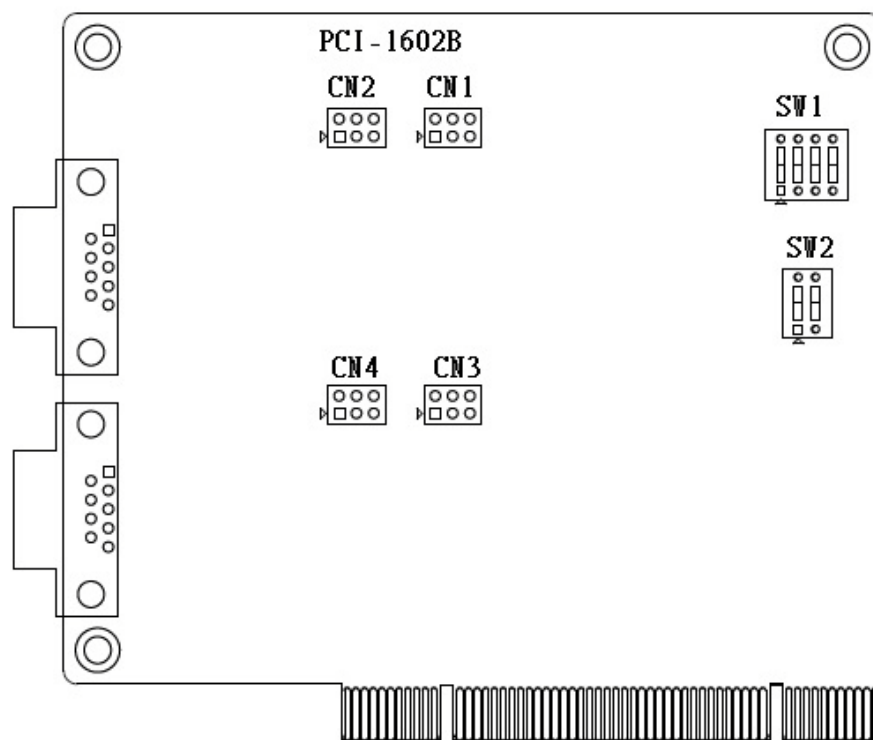

Figure 2.1 PCI-1602B Silk Screen

2.2.2 PCI-1602C/PCI-1604C

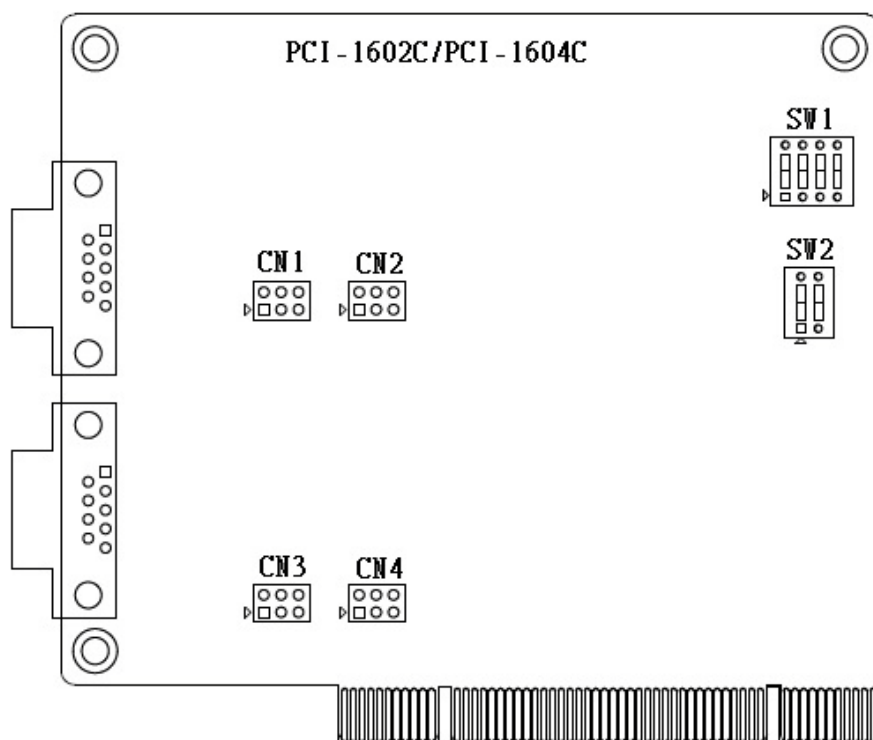

Figure 2.2 PCI-1602C/1604C Silk Screen

2.2.3 PCI-1602UP

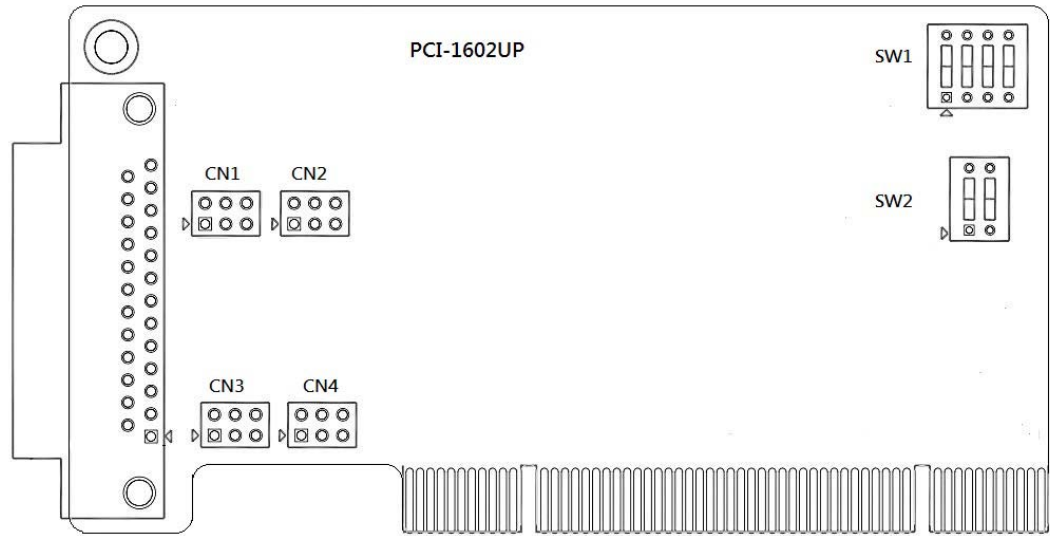

Figure 2.3 PCI-1602UP Silk Screen

2.2.4 PCI-1612B/PCI-1610B

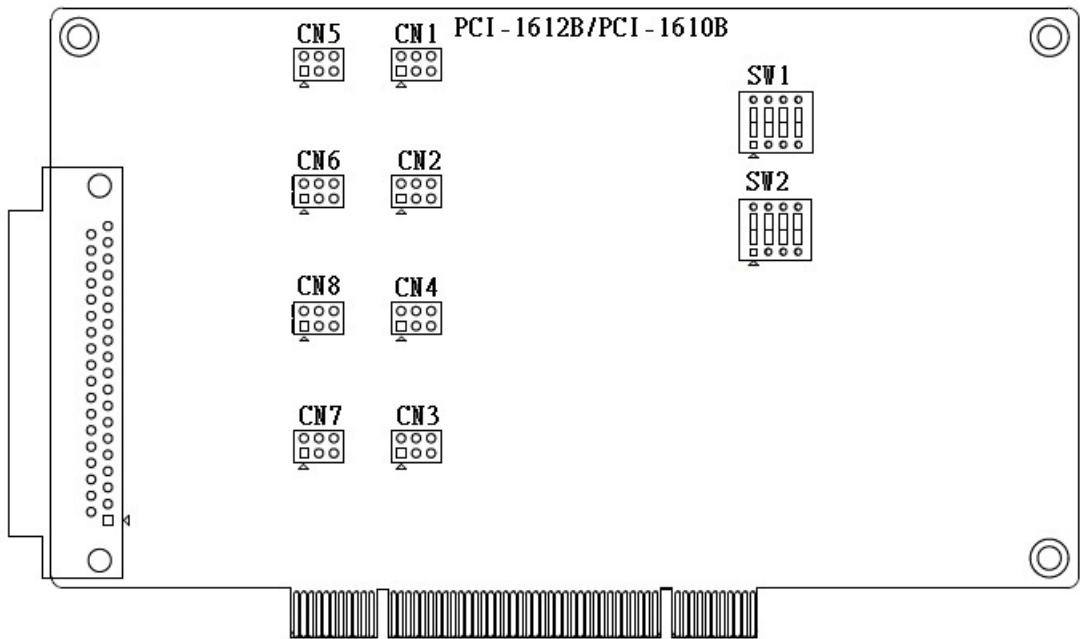

Figure 2.4 PCI-1612B/1610B Silk Screen

2.2.5 PCI-1612C/PCI-1610C

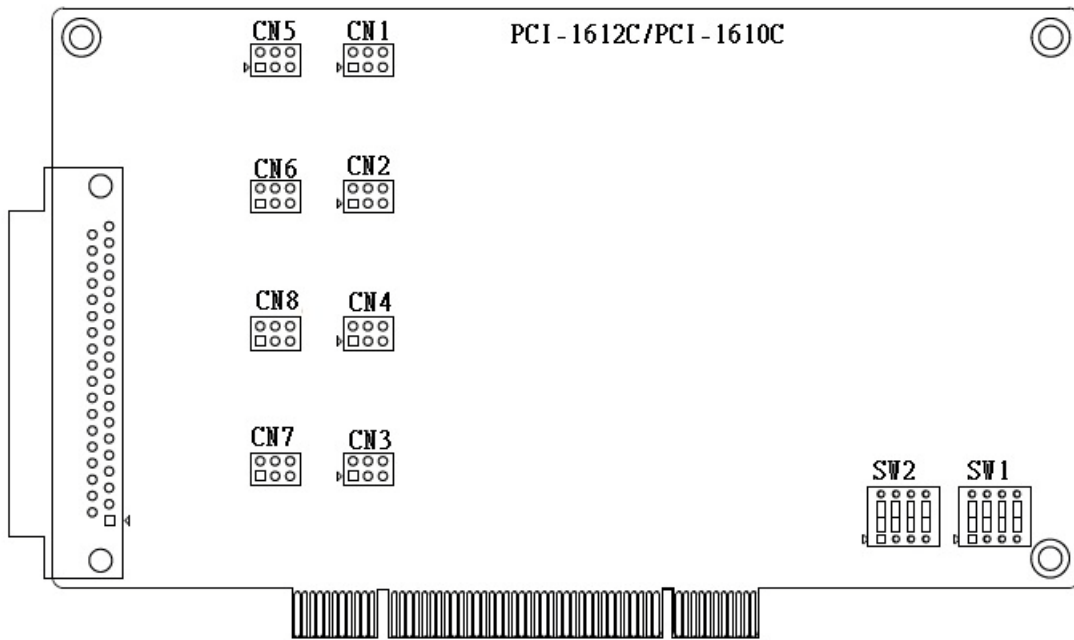

Figure 2.5 PCI-1612C/1610C Silk Screen

2.2.6 PCI-1622B/PCI-1620A/PCI-1620B

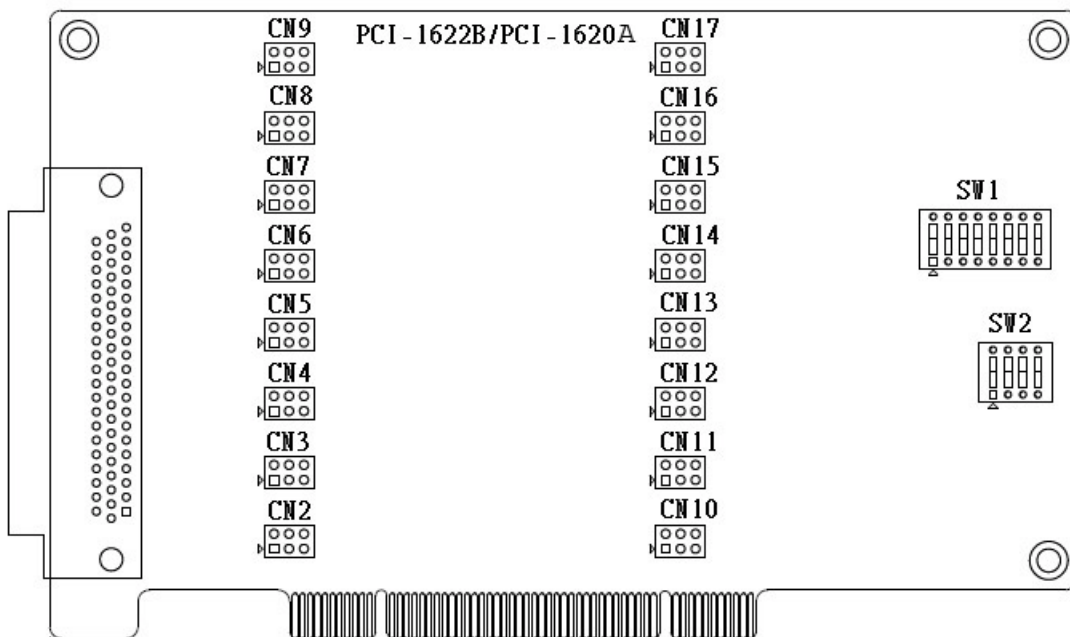

Figure 2.6 PCI-1622B/PCI-1620A/PCI-1620B Silk Screen

2.2.7 PCI-1622C

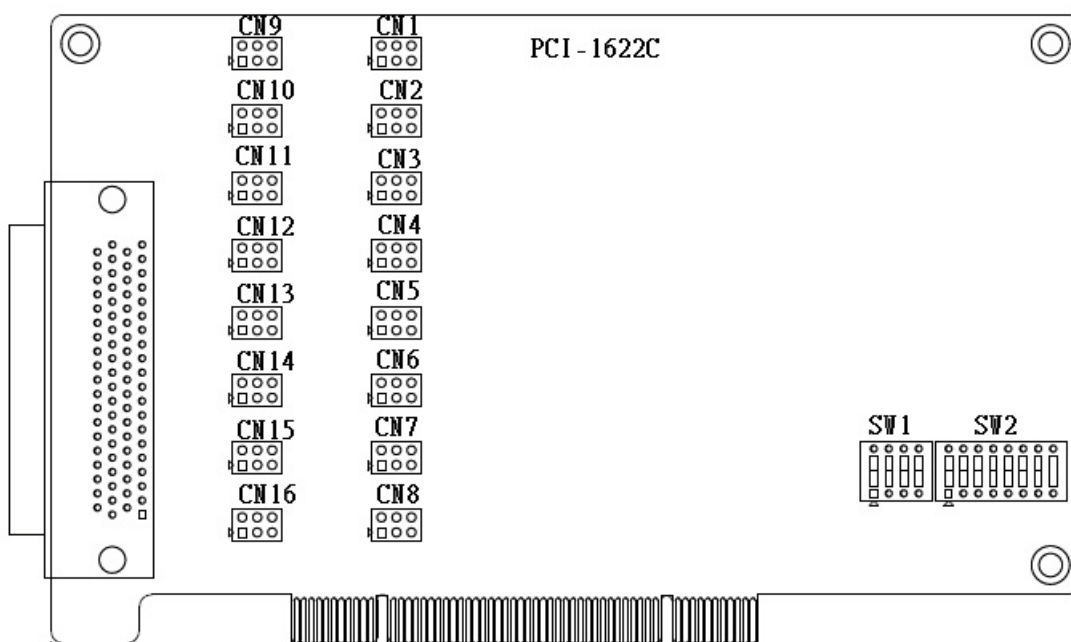

Figure 2.7 PCI-1622C Silk Screen

2.3 Jumper Settings

This section details the possible jumper configurations for your card.

2.3.1 How to Set Jumpers

Configure the card to match the needs of your application by setting the jumpers. A jumper is the simplest type of electric switch. It consists of two metal pins and a small metal clip (typically protected by a plastic cover) that slides over the pins to connect them. To “close” a jumper, connect the pins with the clip. To “open” a jumper, remove the clip. You may find a pair of needle-nose pliers useful for setting the jumpers.

If you have any doubts about the best hardware configuration for your application, contact your local distributor or sales representative before making any changes.

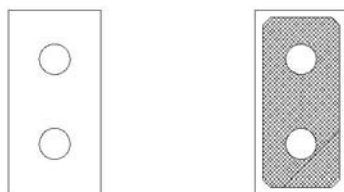

Open

Closed

Figure 2.8 How to Set the Jumpers

2.3.2 Default Settings

The card is shipped with default settings. If you need to change these settings, please refer to the following sections.

PCI-1600 Series Communication Card Settings

Model	Specifications	Default Setting	Tx Enable Mode	Remarks
PCI-1602B/1602C	RS-232/422/485	RS-232	Auto	*Jumpers are provided for terminator use and packed in the PE bag along with the card
PCI-1604C	RS-232	RS-232	N/A	
PCI-1610B/1610C	RS-232	RS-232	N/A	
PCI-1612B/1612C	RS-232/422/485	RS-232	Auto	
PCI-1620A/PCI-1620B	RS-232	RS-232	N/A	
PCI-1622B/1622C	RS-232/422/485	RS-232	Auto	
PCI-1602UP	RS-232/422/485	RS-232	Auto	

2.3.3 Mode Selection by Jumper/DIP Settings

2.3.3.1 RS232/422/485 Selection (PCI-1602B/1602C/1612B/1612C/1622B/1622C)

Should you wish to configure the PCI communication card to operate in the RS-232 or RS422/RS-485 mode, you will locate jumpers at CNX to make connection as shown below.

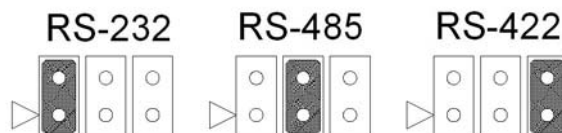

Figure 2.9 PCI-1600 Series RS-232/422/485 Selection

Table 2.1: PCI-1600 Series Operating Mode Jumper Position

Model	CH1	CH2	CH3	CH4	CH5	CH6	CH7	CH8
PCI-1602B	CN1	CN3						
PCI-1602C	CN1	CN3						
PCI-1612B	CN1	CN2	CN3	CN4				
PCI-1612C	CN1	CN2	CN3	CN4				
PCI-1622B	CN10	CN11	CN12	CN13	CN14	CN15	CN16	CN17
PCI-1622C	CN1	CN2	CN3	CN4	CN5	CN6	CN7	CN8
PCI-1602UP	CN1	CN3						

2.3.3.2 Board ID Function (SW1)

The comm. cards feature a built-in DIP switch for defining the card's board ID. When multiple cards are installed, the board ID switch is useful for identifying the device number of each card.

After setting each COM card, you can identify each card installed in the system according to their device numbers. The default board ID value is 0 (disabled). To adjust the board ID value, configure SW1 according to Table 2.2.

After COM ports have been created, the COM port number will be linked to the board ID even if the card is moved to a different PCI/PCIE slot. This is a useful function for maintenance and mass production applications.

(PCI-1620A/PCI-1620B/PCI-1622B are SW2)

Table 2.2: Board ID Setting

SW	Position 3	Position 2	Position 1	Position 0
BoardID	BID3	BID2	BID1	BID0
0	ON	ON	ON	ON
1	ON	ON	ON	OFF
2	ON	ON	OFF	ON
3	ON	ON	OFF	OFF
4	ON	OFF	ON	ON
5	ON	OFF	ON	OFF
6	ON	OFF	OFF	ON
7	ON	OFF	OFF	OFF
8	OFF	ON	ON	ON
9	OFF	ON	ON	OFF
10	OFF	ON	OFF	ON

Table 2.2: Board ID Setting

11	OFF	ON	OFF	OFF
12	OFF	OFF	ON	ON
13	OFF	OFF	ON	OFF
14	OFF	OFF	OFF	ON
15	OFF	OFF	OFF	OFF

Note: On: 0, Off: 1

2.3.3.3 Tx Enable Mode Selection (SW2)

Tx Enable Mode is set by two, four, or eight position DIP switches (one for each port). If a switch is set to “On,” the driver of the corresponding port will always be enabled, and the COM port will change to RS-422 master mode, which means that the Tx output is always enabled. If a switch is set to “OFF,” the driver will be in Auto Direction Control Mode. You must select a mode before beginning any RS-422 applications. (PCI-1620A/PCI-1620B/PCI-1622B are SW1)

Table 2.3: Tx Enable Mode Selection

Mode	Switch Position	Description
RS-422_Master	ON	Tx always enabled
RS-422_Slave/RS-485	OFF	Auto direction control enabled

Note! Do not set termination resistors in RS232 mode.



2.3.3.4 Termination Setup (for PCI-1602B/1602C/1612B/1612C/1622B/1622C)

If necessary, you can set termination resistors to match the impedance. Each signal line (Tx, Rx) has a separate resistor.

Note! *Especially in fields with serious electric noise, setting termination resistors is helpful to stabilize communications. Ensure that both sides of the RS-485 bus have termination resistors. See Sections 5.2.2 and 5.2.3 for further details.*



Termination is recommended for when designing an RS-422 interface. RS422 Mode with a terminator resistor is 120 Ω under standard conditions. However, the transmission condition is affected by the impedance of the cable length.

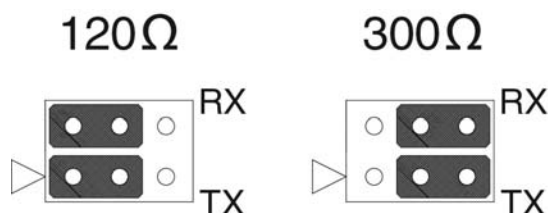

Figure 2.10 Impedance Selection (PCI-1600 Series)

Table 2.4: PCI-1600 Series Impedance Selection Jumper Position

Model	CH1	CH2	CH3	CH4	CH5	CH6	CH7	CH8
PCI-1602B	CN2	CN4						
PCI-1602C	CN2	CN4						
PCI-1612B	CN5	CN6	CN7	CN8				
PCI-1612C	CN5	CN6	CN7	CN8				
PCI-1622B	CN2	CN3	CN4	CN5	CN6	CN7	CN8	CN9
PCI-1622C	CN9	CN10	CN11	CN12	CN13	CN14	CN15	CN16
PCI-1602UP	CN2	CN4						

Note! *Do not set termination resistors under RS232 mode.*



2.4 Card Installation

Note! We strongly recommend that you install the software driver before installing the hardware. This will guarantee a smooth and trouble-free installation process.



Turn off your PC's power supply whenever you install or remove the PCI comm. card or its cables. Static electricity can easily damage computer equipment. Ground yourself by touching the chassis of the computer (metal) before you touch any boards. See the static warning in Chapter 2.

1. Install the driver (see Sections 3.1 and 3.2 for reference).
2. Turn off the computer and all peripheral devices.
3. Disconnect the power cord and any other cables from the back of the computer.
4. Remove the PC cover (refer to the user manual if necessary).
5. Install the PCI comm. card into your PCI bus.
6. Replace the PC cover and reconnect the cables disconnected at Step 3.
7. Turn the computer on.
8. The the PCI comm. card driver will install automatically (see Sections 3.3~3.5).
9. Test the COM port and verify normal operation (see Chapter 4).
10. Refer to the pin assignment chart and cabling information (see Chapter 5).

Chapter 3

Driver Setup and
Installation

3.1 Introduction

This chapter describes the driver installation, configuration, and uninstall procedures for Windows. We strongly recommend installing the software driver before the hardware. This will guarantee a smooth and trouble-free installation process.

3.2 Driver Setup

Windows supports up to 256 serial ports (COM1~COM256). To fully utilize the advanced features of Windows (e.g., multiprocessing and multithreading), Windows 7/8/10 (and other versions) device drivers that are provided with the PCI comm. card all conform to the COMM API standard.

3.2.1 Operating System Driver Setup

Follow these steps to install your PCI comm. card driver on Windows:

1. Insert the DVD into your drive.
2. The driver setup program will launch automatically. If the AutoPlay function is not enabled on your system, use Windows Explorer or the Windows Run command to execute autorun.exe on the DVD.
3. After the setup program is launched, the following screen will appear:



4. Click **Continue** and the catalogue select page will appear. Click **Installation** to view the installation options.



5. Choose the driver you want to install, then click the corresponding hyperlink.

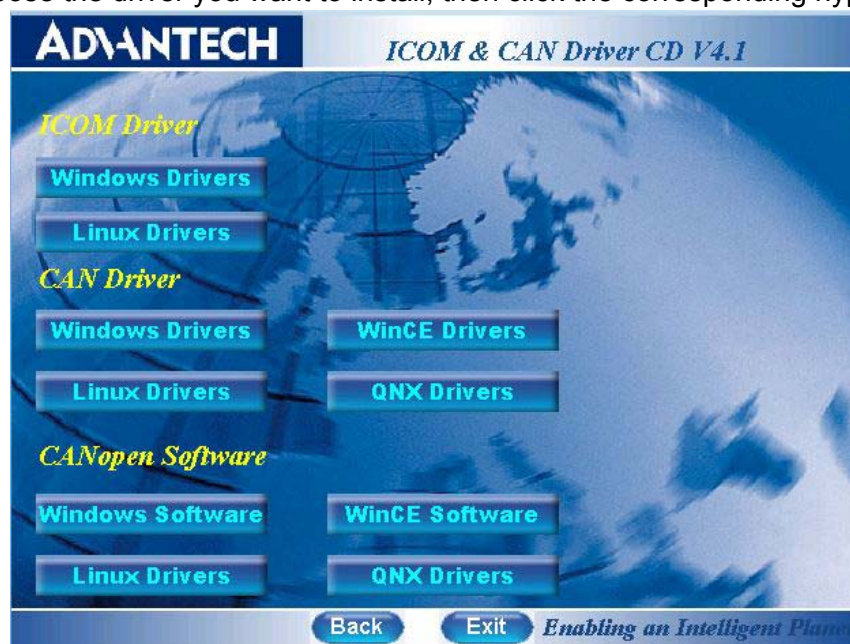

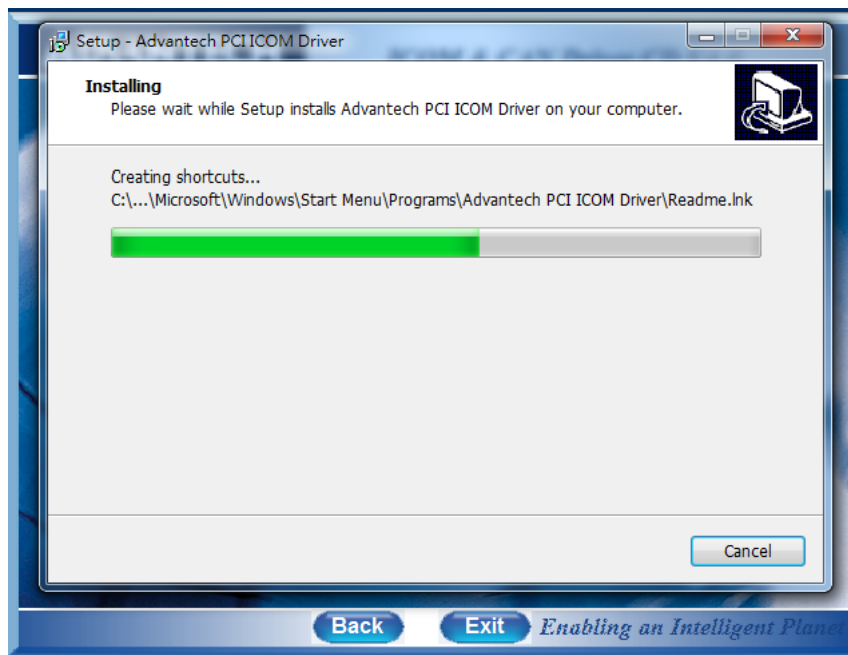
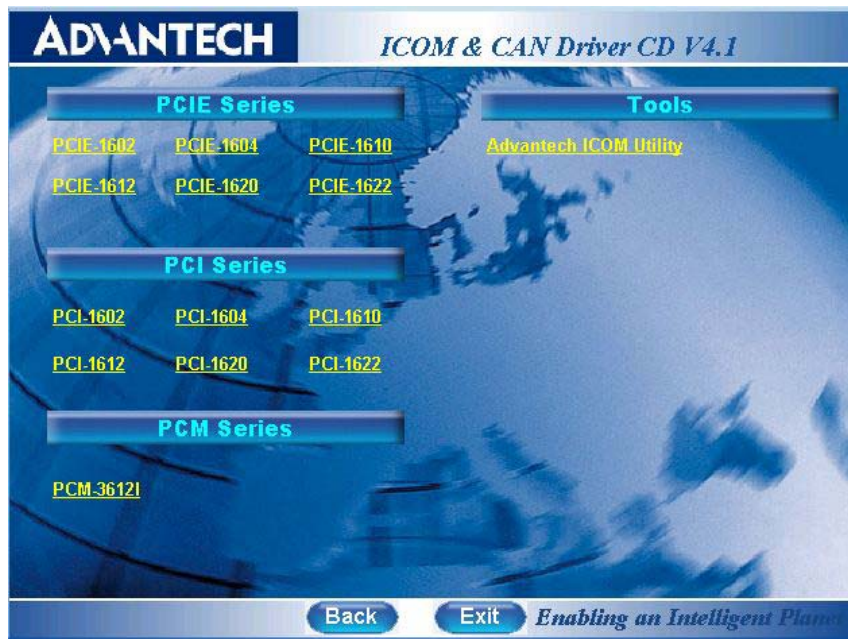

3.3 Driver Uninstall

1. To remove the ICOM driver, click **Uninstall** inside the Start Menu folder and follow the prompts.

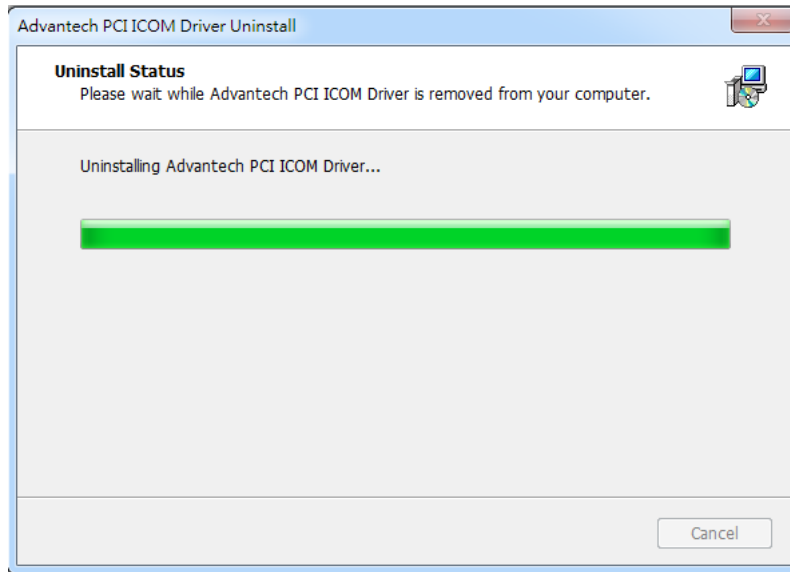
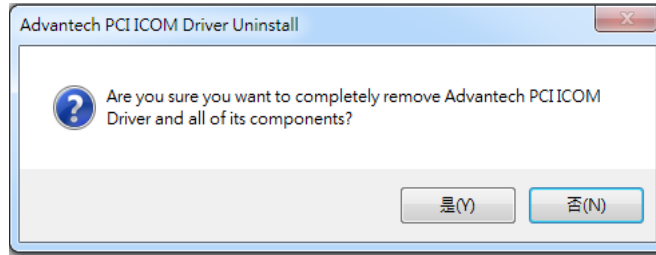

Chapter 4

ICOM Tools

4.1 Introduction

Advantech ICOM Tools provide a convenient utility to help you test the performance of ICOM cards through analyzing the port status. They feature a user-friendly GUI with testing options available via menu commands and toolbar buttons.

Advantech ICOM Tools are applicable to all series of Advantech ICOM cards, and may even be used with third-party ICOM cards. It is included on the companion DVD with all Advantech industrial communication cards.

4.2 Installation

To begin installation, double-click the **ICOM_Tools.exe** icon in the **Tools** folder or click the **Advantech ICOM Utility** hyperlink in the installation window to launch the ICOM Tools setup program. The setup program will copy the program files to a specified destination folder or the default installation path (i.e. C:\Program Files\Advantech\ICOM Tools). A program folder will be created in your Start/Programs menu (you can access the program through Start/Program/Advantech PCI Comm Tools/COM Examine Tool).

4.3 ICOM Tools User Interface

4.3.1 Menu Bar



The menus contain various commands for port testing. You can also use short-cut keys.

Port

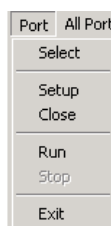

Select: Select the ports you want to configure

Setup: Setup the configuration of a specific port

Close: Close a specific port

Run: Run the test on a specific port

Stop: Stop the test on a specific port

All Ports



Setup: Setup the configuration of all ports

Run: Run the test on all ports

Stop: Stop the test on all ports









Help

This menu allows you to access online help.

4.3.2 Tool Bar



The toolbar icons are described as follows:

	Port Select: Selects the port(s) you want to perform testing on
	Port Setup: Sets up configuration of the port you have selected
	Port Close: Closes the port you have selected
	Port Run: Runs the port test on the port you have selected
	Port Stop: Stops the port test on the port you have selected
	All Ports Setup: Sets up the configuration of all ports not running tests
	All Ports Run: Runs the test on all ports
	All Ports Stop: Stops the test on all ports
	Clear Message: Clears messages in the Message Logo panel and the Rx length information in the Performance Listing panel

4.3.3 Com Port Tab

Each COM tab represents a specific port you have selected for testing and configuration. Each tab contains a **Transfer Mode**, **Port Status**, and **Message Logo** panel.

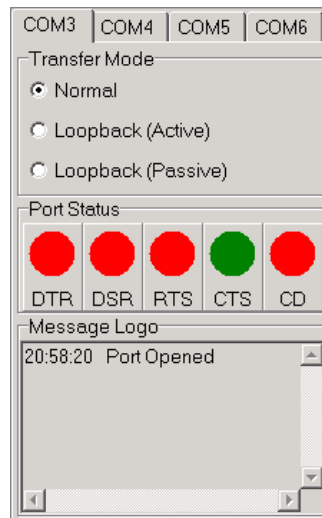

Transfer Modes

You can specify the transfer mode to be **Normal**, **Loopback (Active)**, or **Loopback (Passive)**.

Normal: This setting enables simultaneous data transmission/reception. The data signalling rate is helpful for identifying the performance of a communication card installed on your system.

Loopback (Active)/Loopback (Passive): In loopback mode, a series of transmitted data are expected to appear with the same structure on the receiving end. Using loopback mode, you can check the integrity of the received data and determine whether a transmission error has occurred. Active and passive loopback work in tandem; under active loopback mode, a port will send data first and then receive data later, whereas under passive mode, a port will take data received on the Rx line and retransmit it via the Tx line. These two modes form a logical loop.

4.3.4 Port Status

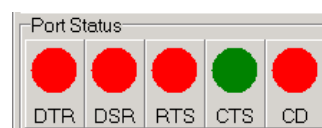

The port status labels are defined as follows:

- DTR: Data terminal ready
- DSR: Data set ready
- RTS: Request to send
- CTS: Clear to send
- CD: Carrier detect

For RS-232 specifications, DTR and RTS are for output signals and can be toggled on/off by double-clicking the corresponding labels. However, if you are using RTS/CTS for flow control to run the test, you will notice that RTS appears in black. This indicates that the RTS can no longer be toggled on/off since it is controlled by the driver.

4.3.5 Message Logo

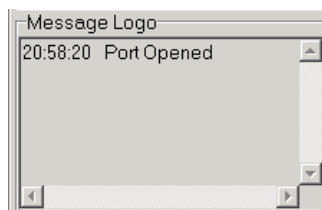

The **Message Logo** panel displays relevant messages about the port(s) you have selected. See Section 4.5 for information on the messages that are shown in this panel.

4.3.6 Tx Slide Bar

The **Tx** slide bar gives you control of the overall system loading. With this, the transmission rate of your port(s) can be set from 0% to 100%.



4.3.7 Performance

The **Performance** panel displays information on the Rx length (received packet byte length), transmission rate (B/s), and last abnormal status of each port being tested.

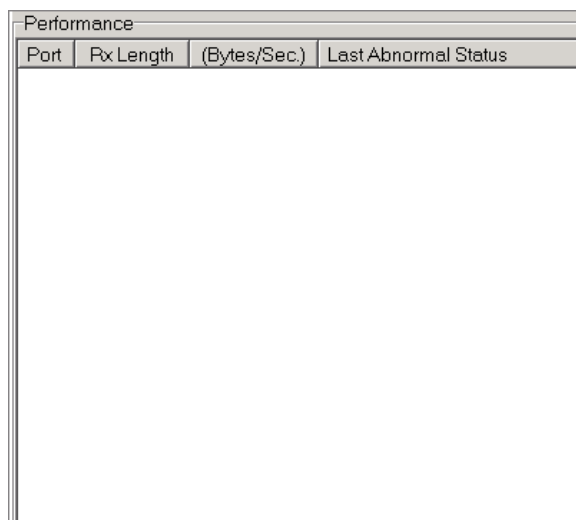

4.3.8 Status Bar

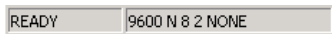

The status bar displays current information on the selected port. It indicates whether a port is ready, running, busy, stopped, or not applicable. It also shows the baud rate, data bit, stop bit, parity bit, and flow control (e.g., 1200 N 8 1 NONE), with the test duration shown in hh:mm:ss format on the right. See Section 4.5 for information on the messages that appear in this panel.

4.4 Using the ICOM Tools Utility

To launch the ICOM Tools Utility, access Start/Programs/Advantech PCI Comm Tools/COM Examine Tools.

4.4.1 Port Selection

Follow these steps for port selection:

1. Launch ICOM Tools. The program window is shown in Figure 4.1. The window will be blank if you have not yet selected a port.



Figure 4.1 ICOM Tools Program Window

2. There are two ways to select ports: 1) on the **Port** menu, click **Select**; or 2) press the **Port Select** button  on the toolbar. This will open the **Select Port** dialog box (Figure 4.2).

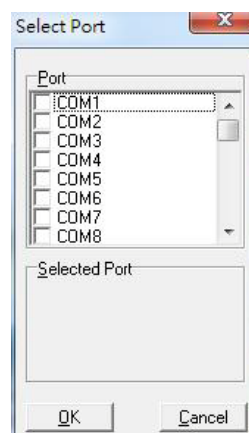

Figure 4.2 “Select Port” Dialog Box

Choose which port(s) you want to test by selecting the checkbox or double-clicking the port name(s) (you can do the same to deselect a port). The ports you select will immediately appear in the **Selected Port** panel (see Figure 4.3).

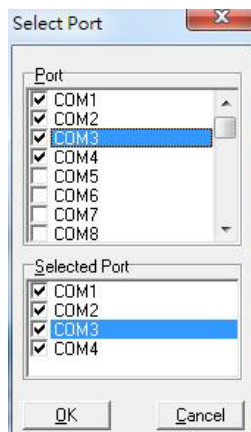

Figure 4.3 “Selected Port” Panel

Click **OK** to view the ICOM Tools user interface (Figure 4.4).

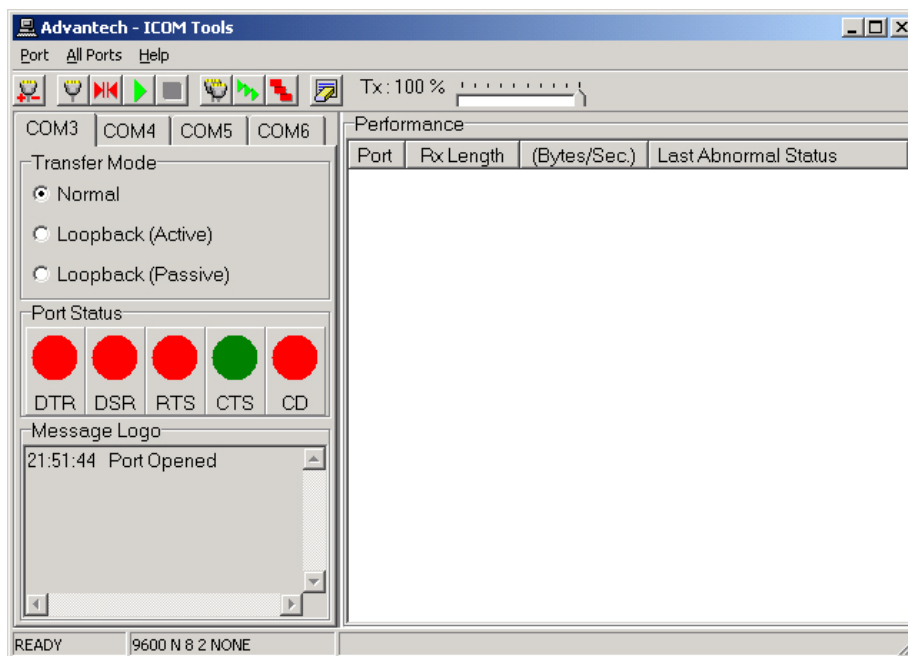



Figure 4.4 ICOM Tools User Interface

4.4.2 Configuring a Port

You can choose to configure a specific port before running your test. Simply click the corresponding port tab (**COM1**, **COM2**, etc.) and then press the **Port Setup** button  on the toolbar or click **Setup** on the **Port** menu. To configure all ports, press the **All Ports Setup** button  on the toolbar or click **Setup** on the **All Ports** menu. This will open the **Configure Port** dialog box (Figure 4.5).

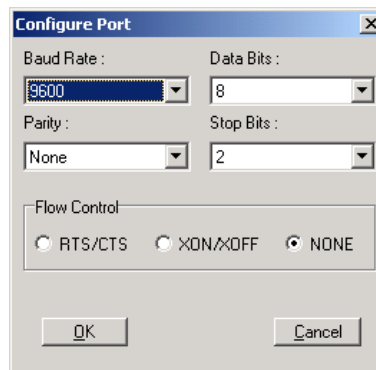





Figure 4.5 Test Information on the Performance Listing Area

In the **Configure Port** dialog box, you can configure the baud rate, data bits, parity, stop bits, and flow control mode for the specified port (or for all ports). Once you have configured the ports, click **OK** to apply the configuration.

Note!  *When setting up all ports, you must stop any ports that are running the test or they will not be configured. In other words, you can configure only those ports that have been stopped.*

Run the Test

After the ports have been configured, you can start the test on the selected port by pressing the **Run** button  on the toolbar or by clicking **Run** on the **Port** menu. Similarly, to run the test on all ports, press the **All Ports Run** button  on the toolbar or click **Run** on the **All Ports** menu. Once the test has started, information on port performance will be shown in the **Performance** panel.

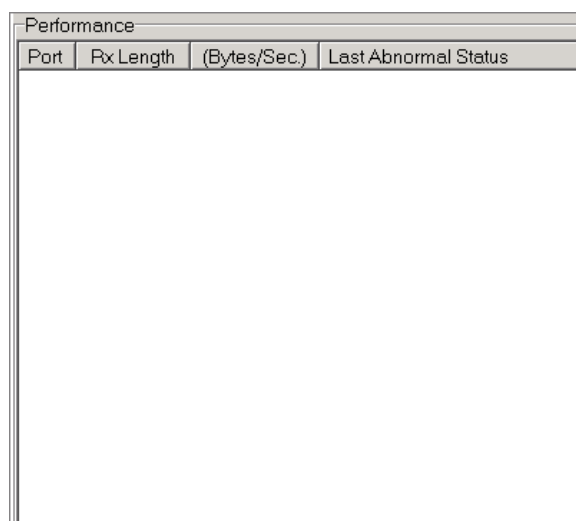





Figure 4.6 “Performance” Panel

The columns in the **Performance** panels are explained briefly as follows:

Port	COM port number
Rx Length (Bytes/Sec.)	Received packet length (in bytes) Transmission rate
Last Abnormal Status	Last abnormal status

Stop the Test

To stop the test on a specific port, press the **Port Stop** button  on the toolbar or click **Stop** on the **Port** menu. To stop the test on all ports, press the **All Ports Stop** button  on the toolbar or click **Stop** on the **All Ports** menu. You can restart the test by pressing the **Run** button  on the toolbar or by clicking **Run** on the **Port** menu. To run all ports at once, press the **All Ports Run** button  on the toolbar or click **Run** on the **All Ports** menu.

4.4.3 Close Port

If you want to close a port, go to the tab for the com port you wish to close and press the **Port Close** button  or click **Close** on the **Port** menu.

4.4.4 Exit the ICOM Tools Utility

To exit the ICOM Tools utility, click **Exit** on the **Port** menu or press the **Close** button.

4.5 Status Bar and Message Logo Panel Messages

Messages appearing in the **Status Bar** and **Message Logo** panels give specific information on your system settings and performance.

4.5.1 Status Bar Messages

BUSY: The port is currently used by another application.

FAIL: The configuration parameters are not accepted by the port.

N/A PORT: The port is not available in the system.

READY: The port is ready to run or to be configured.

RUNNING: The test is running on the port.

STOPPED: The test running on the port has been manually stopped.

4.5.2 Message Logo Messages

Port Opened: The port has been manually opened.

Port Setup Fail: The port configuration parameters are incorrect or unsupported.

Port Running: The port is running a test.

Port Stopped: The test has stopped on the port.

Tx Starting/Tx Stopped: Transmission has started/stopped.

Rx Starting/Rx Stopped: Reception has started/stopped.

Break Error: A break event has been detected on the port.

Framing Error: A timing error (i.e., from the start bit to the stop bit) has been detected on the port.

Port I/O Error: An incorrect I/O event has been detected on the port.

Rx Overrun: Received data have been overwritten before being processed.

Rx Buffer Full Error: The buffer on the receiving end is full, meaning that newly arrived data will be ignored.

Tx Buffer Full Error: The buffer on the transmitting end is full, meaning that data transmitted by applications will be ignored.

LB Error - %d: Data error detected in loopback.

LB Rx Pending: Loopback mode is waiting for incoming data.

Data Setup Error: Parameter errors in the port configuration.

Chapter 5

Pin Assignments and
Wiring

5.1 Pin Assignments

5.1.1 PCI-1602B/C/UP

The following table shows the pin assignments of two male DB9 connectors on the bracket for the PCI-1602B/C/UP in RS-232, RS-422, and RS-485 modes.

Table 5.1: PCI-1602B/C/UP Male DB9 (Bracket)

Pin	RS-232	RS-422	RS-485
1	DCD	Tx-	Data-
2	RxD	Tx+	Data+
3	TxD	Rx+	N/A
4	DTR	Rx-	N/A
5	GND	GND	GND
6	DSR	RTS-	N/A
7	RTS	RTS+	N/A
8	CTS	CTS+	N/A
9	RI	CTS-	N/A

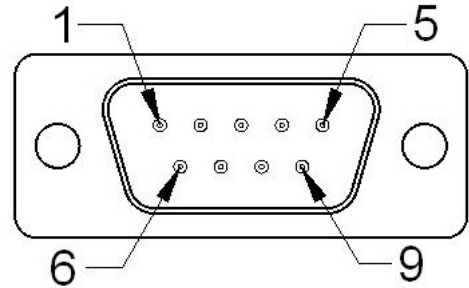

5.1.2 PCI-1604C

The following table shows the pin assignments of two male DB9 connectors on the bracket for the PCI-1604C.

Table 5.2: PCI-1604C Male DB9 (Bracket)

Pin	RS-232
1	DCD
2	RxD
3	TxD
4	DTR
5	GND
6	DSR
7	RTS
8	CTS
9	RI

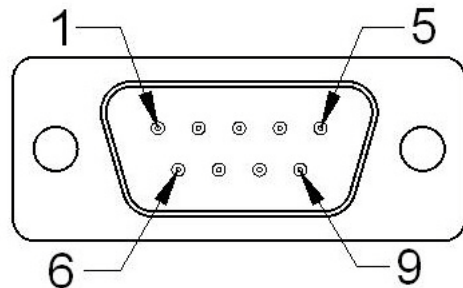

5.1.3 PCI-1610B/C

The following tables show the cable pin assignments for connecting a female DB37 connector (bracket) to a male DB9/DB25 connector for PCI-1610B cards.

Table 5.3: PCI-1610B/C Male DB9 (Cable)

Pin	RS-232
1	DCD
2	RxD
3	TxD
4	DTR
5	GND
6	DSR
7	RTS
8	CTS
9	RI

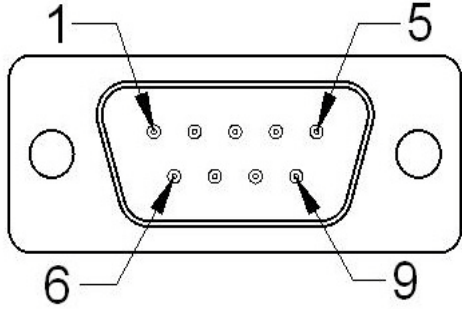

The diagram shows a top-down view of a male DB9 connector. It has a central row of five pins and a bottom row of four pins. The pins are numbered as follows: Pin 1 is the top-left pin, Pin 5 is the top-right pin, Pin 6 is the bottom-left pin, and Pin 9 is the bottom-right pin. There are two circular mounting holes on either side of the connector.

Table 5.4: PCI-1610B/C Male DB25 (Cable)

Pin	RS-232
2	TxD
3	RxD
4	RTS
5	CTS
6	DSR
7	GND
8	DCD
20	DTR
22	RI

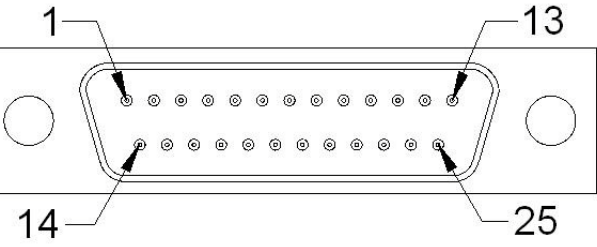

The diagram shows a top-down view of a male DB25 connector. It has a central row of 13 pins and a bottom row of 12 pins. The pins are numbered as follows: Pin 1 is the top-left pin, Pin 13 is the top-right pin, Pin 14 is the bottom-left pin, and Pin 25 is the bottom-right pin. There are two circular mounting holes on either side of the connector.

Table 5.5: PCI-1610B/C Female DB37 (Bracket)

Pin	RS-232	Pin	RS-232
1	-	20	3_RI
2	3_DCD	21	3_DTR
3	3_GND	22	3_DSR
4	3_CTS	23	3_RTS
5	3_RxD	24	3_TxD
6	4_RI	25	4_DCD
7	4_DTR	26	4_GND
8	4_DSR	27	4_CTS
9	4_RTS	28	4_RxD
10	4_TxD	29	2_RI
11	2_DCD	30	2_DTR
12	2_GND	31	2_DSR
13	2_CTS	32	2_RTS
14	2_RxD	33	2_TxD
15	1_RI	34	1_DCD
16	1_DTR	35	1_GND
17	1_DSR	36	1_CTS
18	1_RTS	37	1_RxD
19	1_TxD		

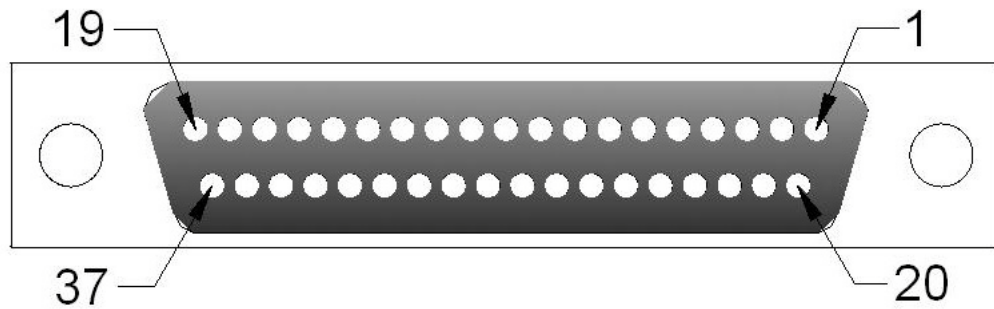

5.1.4 PCI-1612B/C

The following tables show the cable pin assignments for connecting a female DB37 connector (bracket) to a male DB9/DB25 connector for the PCI-1612B/C cards in RS-232, RS-422 and RS-485 modes.

Table 5.6: PCI-1612B/C Male DB9 (Cable)

Pin	RS-232	RS-422	RS-485
1	DCD	Tx-	Data-
2	RxD	Tx+	Data+
3	TxD	Rx+	-
4	DTR	Rx-	-
5	GND	GND	GND
6	DSR	RTS-	-
7	RTS	RTS+	-
8	CTS	CTS+	-
9	RI	CTS-	-

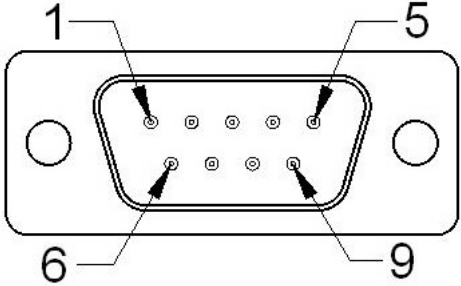

The diagram shows a top-down view of a male DB9 connector. It has a rectangular metal housing with two circular mounting holes on the sides. The connector has nine pins arranged in two rows. The top row contains pins 1, 5, 6, and 9. The bottom row contains pins 2, 3, 4, and 8. Arrows point from the labels 1, 5, 6, and 9 to their respective pins.

Table 5.7: PCI-1612B/C Male DB25 (Cable)

Pin	RS-232	RS-422	RS-485
2	1_TxD	1_RxD	+
3	1_RxD	1_TxD+	1_Data+
4	1_RTS	1_RTS+	-
5	1_CTS	1_CTS+	-
6	1_DSR	1_RTS-	-
7	1_GND	1_GND	1_GND
8	1_DCD	1_TxD-	1_DATA-
20	1_DTR	1_RxD	-
22	1_RI	1_CTS	-

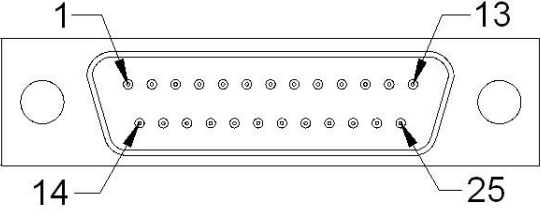

The diagram shows a top-down view of a male DB25 connector. It has a rectangular metal housing with two circular mounting holes on the sides. The connector has 25 pins arranged in two rows. The top row contains pins 1, 13, 14, and 25. The bottom row contains pins 2, 3, 4, 5, 6, 7, 8, 9, 10, 11, 12, 15, 16, 17, 18, 19, 20, 21, 22, 23, 24. Arrows point from the labels 1, 13, 14, and 25 to their respective pins.

Table 5.8: PCI-1612B/C Female DB37 (Bracket)

Pin	RS-232	RS-422	RS-485	Pin	RS-232	RS-422	RS-485
1	-	-	-	20	3_RI	3_CTS-	-
2	3_DCD	3_TxD-	3_Data-	21	3_DTR	3_RxD-	-
3	3_GND	3_GND	3_GND	22	3_DSR	3_RTS-	-
4	3_CTS	3_CTS+	-	23	3_RTS	3_RTS+	-
5	3_RxD	3_TxD+	3_Data+	24	3_TxD	3_RxD+	-
6	4_RI	4_CTS-	-	25	4_DCD	4_TxD-	4_Data-
7	4_DTR	4_RxD-	-	26	4_GND	4_GND	4_GND
8	4_DSR	4_RTS-	-	27	4_CTS	4_CTS+	-
9	4_RTS	4_RTS+	-	28	4_RxD	4_TxD+	4_Data+
10	4_TxD	4_RxD+	-	29	2_RI	2_CTS-	-
11	2_DCD	2_TxD-	2_Data-	30	2_DTR	2_RxD-	-
12	2_GND	2_GND	2_GND	31	2_DSR	2_RTS-	-
13	2_CTS	2_CTS+		32	2_RTS	2_RTS+	-
14	2_RxD	2_TxD+	2_Data+	33	2_TxD	2_RxD+	-
15	1_RI	1_CTS-	-	34	1_DCD	1_TxD-	1_Data-
16	1_DTR	1_RxD-	-	35	1_GND	1_GND	1_GND
17	1_DSR	1_RTS-	-	36	1_CTS	1_CTS+	-
18	1_RTS	1_RTS+	-	37	1_RxD	1_TxD+	1_Data+
19	1_TxD	1_RxD+	+	-	-	-	-

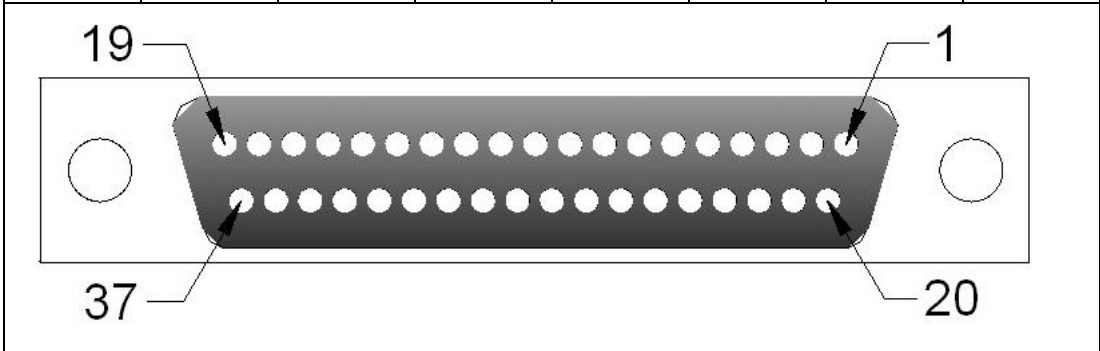

5.1.5 PCI-1620A, PCI-1620B and PCI-1622B

The following tables show the cable pin assignments for connecting a female DB62 connector (bracket) to a DB9 connector for the PCI-1620A, PCI-1620B, and PCI-1622B.

Table 5.9: PCI-1620A, PCI-1620B and PCI-1622B Female DB62 (Bracket)

Pin	RS-232	RS-422	RS-485	Pin	RS-232	RS-422	RS-485
1	1_TX	1_RX+	-	32	GND	GND	GND
2	1_DTR	1_RX-	-	33	5_TX	5_RX+	-
3	2_RX	2_TX+	2_Data+	34	5_DTR	5_RX-	-
4	2_DSR	-	-	35	6_RX	6_TX+	6_Data+
5	2_DCD	2_TX-	2_Data-	36	6_DSR	-	-
6	3_TX	3_RX+	-	37	6_DCD	6_TX-	6_Data-
7	3_DTR	3_RX-	-	38	7_TX	7_RX+	-
8	4_RX	4_TX+	4_Data+	39	7_DTR	7_RX-	-
9	4_DSR	-	-	40	GND	GND	GND
10	4_DCD	4_TX-	4_Data-	41	8_TX	8_RX+	-
11	5_RX	5_TX+	5_Data+	42	8_DTR	8_RX-	-
12	5_DSR	-	-	43	1_CTS	-	-
13	5_DCD	5_TX-	5_Data-	44	1_RTS	-	-
14	6_TX	6_RX+	-	45	GND	GND	GND
15	6_DTR	6_RX-	-	46	2_CTS	-	-
16	7_RX	7_TX+	7_Data+	47	2_RTS	-	-
17	7_DSR	-	-	48	3_CTS	-	-
18	7_DCD	7_TX-	7_Data-	49	3_RTS	-	-
19	8_RX	8_TX+	8_Data+	50	GND	GND	GND
20	8_DSR	-	-	51	4_CTS	-	-
21	8_DCD	8_TX-	8_Data-	52	4_RTS	-	-
22	1_RX	1_TX+	1_Data+	53	5_CTS	-	-
23	1_DSR	-	-	54	5_RTS	-	-
24	1_DCD	1_TX-	1_Data-	55	GND	GND	GND
25	2_TX	2_RX+	-	56	6_CTS	-	-
26	2_DTR	2_RX-	-	57	6_RTS	-	-
27	3_RX	3_TX+	3_Data+	58	GND	GND	GND
28	3_DSR	-	-	59	7_CTS	-	-
29	3_DCD	3_TX-	3_Data-	60	7_RTS	-	-
30	4_TX	4_RX+	-	61	8_CTS	-	-
31	4_DTR	4_RX-	-	62	8_RTS	-	-

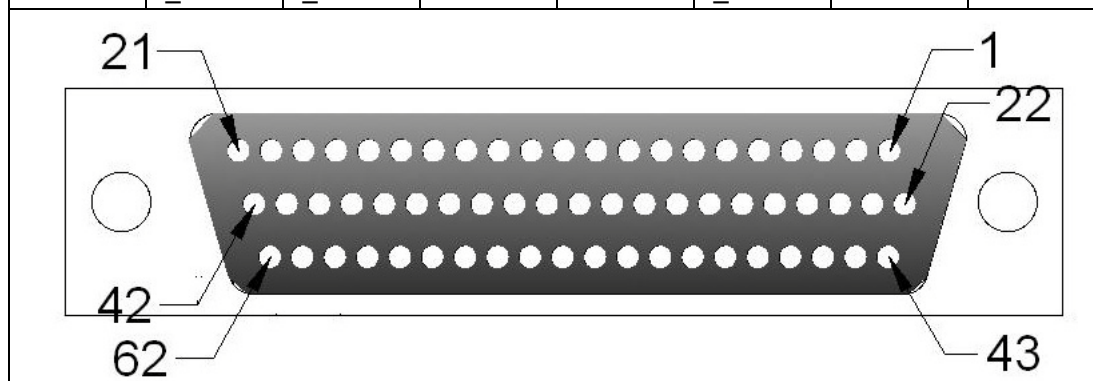

Table 5.10: PCI-1622B Male DB9 (Cable)

Pin	RS-232	RS-422	RS-485
1	DCD	TX-	Data-
2	RxD	TX+	Data+
3	TxD	RX+	-
4	DTR	RX-	-
5	GND	GND	GND
6	DSR	-	-
7	RTS	-	-
8	CTS	-	-

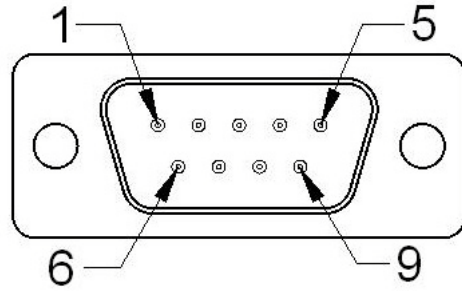

Table 5.11: PCI-1620A and PCI-1620B Male DB9 (Cable)

Pin	RS-232
1	DCD
2	RxD
3	TxD
4	DTR
5	GND
6	DSR
7	RTS
8	CTS
9	RI

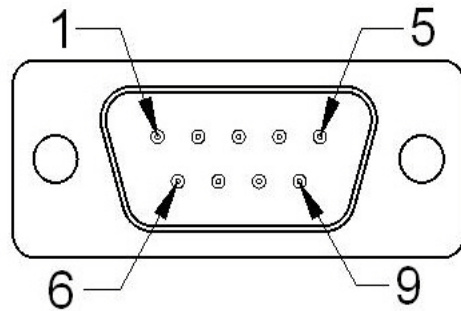
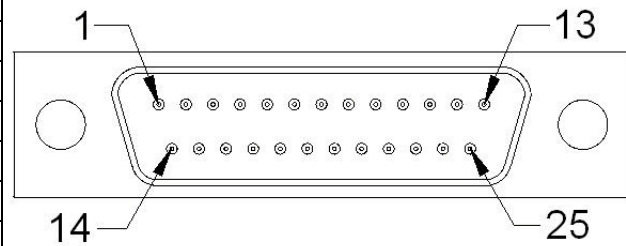

Table 5.12: PCI-1622B Male DB25 (Cable)

Pin	RS-232	RS-422	RS-485
1	-	-	-
2	TxD	RX+	-
3	RxD	TX+	Data+
4	RTS	-	-
5	CTS	-	-
6	DSR	-	-
7	GND	GND	GND
8	DCD	TX-	Data-
20	DTR	RX-	-



5.1.6 PCI-1622C

The following table shows the cable pin assignments for connecting a female DB78 connector (bracket) to a DB9 connector for the PCI-1622C in RS-232, RS-422, and RS-485 modes.

Table 5.13: PCI-1622C Male DB9 (Cable)

Pin	RS-232	RS-422	RS-485
1	DCD	Tx-	Data-
2	RxD	Tx+	Data+
3	TxD	Rx+	N/A
4	DTR	Rx-	N/A
5	GND	GND	GND
6	DSR	RTS-	N/A
7	RTS	RTS+	N/A
8	CTS	CTS+	N/A
9	RI	CTS-	N/A

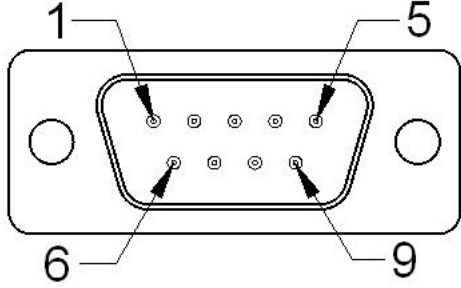

The diagram shows a top-down view of a DB9 connector. It is a rectangular metal housing with a central 9-pin D-sub connector. The pins are arranged in two rows: five pins in the top row and four pins in the bottom row. Four pins are specifically labeled with numbers and arrows: Pin 1 is the top-left pin, Pin 5 is the top-right pin, Pin 6 is the bottom-left pin, and Pin 9 is the bottom-right pin. There are two circular mounting holes on the left and right sides of the housing.

Table 5.14: PCI-1622C Female DB78 (Bracket)

Pin	RS-232	RS-422	RS-485	Pin	RS-232	RS-422	RS-485
1	8_GND	8_GND	8_GND	40	8_DCD	8_TxD-	8_Data-
2	8_DSR	8_RTS-	-	41	8_RxD	8_TxD+	8_Data+
3	8_RTS	8_RTS+	-	42	7_GND	7_GND	7_GND
4	7_DSR	7_RTS-	-	43	7_DCD	7_TxD-	7_Data-
5	7_RTS	7_RTS+	-	44	7_RxD	7_TxD+	7_Data+
6	6_DSR	6_RTS-	-	45	6_DCD	6_TxD-	6_Data-
7	6_RTS	6_RTS+	-	46	6_RxD	6_TxD+	6_Data+
8	-	-	-	47	5_GND	5_GND	5_GND
9	5_DSR	5_RTS-	-	48	5_DCD	5_TxD-	5_Data-
10	5_RTS	5_RTS+	-	49	5_RxD	5_TxD+	5_Data+
11	4_DSR	4_RTS-	-	50	4_DCD	4_TxD-	4_Data-
12	4_RTS	4_RTS+	-	51	4_RxD	4_TxD+	4_Data+
13	-	-	-	52	3_GND	3_GND	3_GND
14	3_DSR	3_RTS-	-	53	3_DCD	3_TxD-	3_Data-
15	3_RTS	3_RTS+	-	54	3_RxD	3_TxD+	3_Data+
16	2_DSR	2_RTS-	-	55	2_DCD	2_TxD-	2_Data-
17	2_RTS	2_RTS+	-	56	2_RxD	2_TxD+	2_Data+
18	-	-	-	57	1_GND	1_GND	1_GND
19	1_DSR	1_RTS-	-	58	1_DCD	1_TxD-	1_Data-
20	1_RTS	1_RTS+	-	59	1_RxD	1_TxD+	1_Data+
21	8_CTS	8_CTS+	-	60	8_TxD	8_RxD+	-
22	8_RI	8_CTS-	-	61	8_DTR	8_RxD-	-
23	7_CTS	7_CTS+	-	62	7_TxD	7_RxD+	-
24	7_RI	7_CTS-	-	63	7_DTR	7_RxD-	-
25	-	-	-	64	6_GND	6_GND	6_GND
26	6_CTS	6_CTS+	-	65	6_TxD	6_RxD+	-
27	6_RI	6_CTS-	-	66	6_DTR	6_RxD-	-
28	5_CTS	5_CTS+	-	67	5_TxD	5_RxD+	-
29	5_RI	5_CTS-	-	68	5_DTR	5_RxD-	-
30	-	-	-	69	4_GND	4_GND	4_GND
31	4_CTS	4_CTS+	-	70	4_TxD	4_RxD+	-
32	4_RI	4_CTS-	-	71	4_DTR	4_RxD-	-
33	3_CTS	3_CTS+	-	72	3_TxD	3_RxD+	-
34	3_RI	3_CTS-	-	73	3_DTR	3_RxD-	-
35	-	-	-	74	2_GND	2_GND	2_GND
36	2_CTS	2_CTS+	-	75	2_TxD	2_RxD+	-
37	2_RI	2_CTS-	-	76	2_DTR	2_RxD-	-
38	1_CTS	1_CTS+	-	77	1_TxD	1_RxD+	-
39	1_RI	1_CTS-	-	78	1_DTR	1_RxD-	-

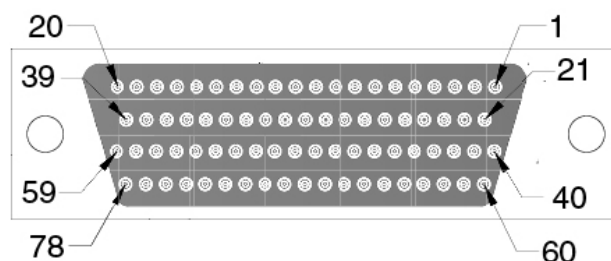

5.2 Wiring

5.2.1 RS-232 Signal Wiring

Since the RS-232 interface is not strictly defined, many devices have their own connection methods, and these may ignore some signal lines or lines reserved for other functions. It is best to refer to the user manual of your device for installation instructions. You may find the following helpful.

In general, data terminal equipment (DTE) refers to a device that communicates with data circuit-terminating equipment (DCE). DTE examples include PCs, terminals, and some printers; whereas DCE examples include modems, digital service units (DSUs), printers, and lab/factory equipment.

In some situations you may be able to get by with just three lines: data on TxD, a signal ground, and a handshaking line. Examples where this would work are printer or plotter connections, troubleshooting, and situations where you require only one-wire communication.

Table 5.15: Terminal or PC (DTE) Connections			
DB-25 Male		DB-25 Male or Female: Terminal	
Pin	Signal	Pin	Signal
2	TxD	3	RxD
3	RxD	2	TxD
4	RTS	5	CTS
5	CTS	4	RTS
6	DSR	20	DTR
7	GND	7	GND
20	DTR	6	DSR
8	DCD	8	DCD

Table 5.16: Modem Connections			
DB-25 Male		Modem (DCE)	
Pin	Signal	Pin	Signal
2	TxD	3	RxD
3	RxD	2	TxD
4	RTS	5	CTS
5	CTS	4	RTS
6	DSR	20	DTR
7	GND	7	GND
20	DTR	6	DSR
8	DCD	8	DCD

For DTE to DCE connections, use a straight-through cable (i.e., you do not need to reverse Lines 2 and 3, Lines 4 and 5, or Lines 6 and 20 since, in general, DCE RS-232 interfaces are reversed themselves).

Table 5.17: Terminal Without Handshake

DB-25 Male		Terminal, PC (DTE)	
Pin	Signal	Pin	Signal
2	TxD	3	RxD
3	RxD	2	TxD
4	RTS		
5	CTS		
7	GND	7	GND
6	DSR		
20	DTR		
8	DCD		

Therefore, if you are not using CTS, RTS, DSR, DTR, or DCD signals, short Pins 4 and 5 together, and short Pins 6, 8, and 20 together.

5.2.2 RS-422 Signal Wiring

The RS-422 interface wiring is based on the one-on-one principle. The transmit lines on one side connect to the receive lines on the other side (and vice versa). With RS-422, you can transmit and receive data simultaneously (full duplex). The connections are as follows:

Table 5.18: RS-422 DB9 Pin Assignment

DTE (Male DB-9)		Terminal DTE	
Pin	Signal	Pin	Signal
1	TxD-	1	RxD-
2	TxD+	2	RxD+
3	RxD+	3	TxD+
4	RxD-	4	TxD-
5	GND	5	GND
6	RTS-	6	CTS-
7	RTS+	7	CTS+
8	CTS+	8	CTS+

Termination Resistors Setup

Termination resistors are onboard and can be selected by using a jumper for 120 or 300 Ω . Each pair of signal lines has a separate resistor (RxD+/-, TxD+/-).

5.2.3 RS-485 Signal Wiring

The RS-485 standard supports half-duplex communication. This means that just two wires are needed to transmit and receive data. Handshaking signals, such as request-to-send (RTS) are normally used to control the direction of the data flow and to switch the transmission accordingly. In RS-485 mode, PCI-1602/1612/1622 cards automatically sense the direction of the data flow and switch the transmission direction, meaning that no handshaking is necessary. Thus, you can build an RS-485 network with only two wires. This RS-485 control is completely transparent to the user. The software written for half-duplex RS-485 works without modification.

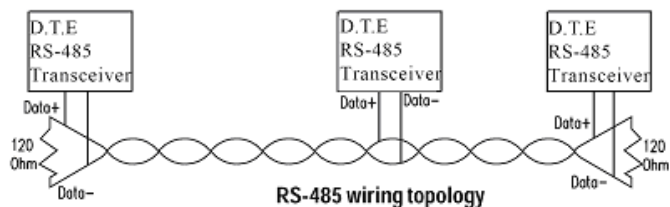

Figure 5.1 RS-485 Wiring Topology

Termination Resistor Setup

Termination resistors are onboard and can be selected by using a jumper for 120 or 300 Ω .

Appendix **A**

Scale of Connectors

A.1 Connector Size Comparison

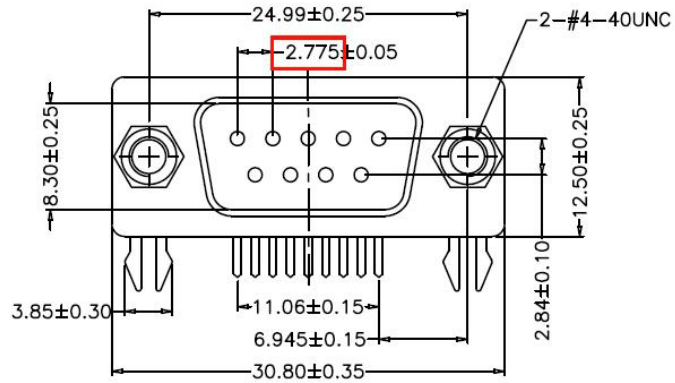

Figure A.1 DB9 Male

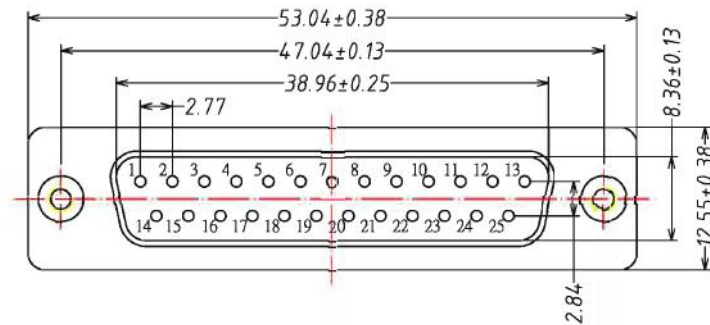

Figure A.2 DB25 Male

POSITION	A	B	C
37 Pin	55.42	63.50	69.32

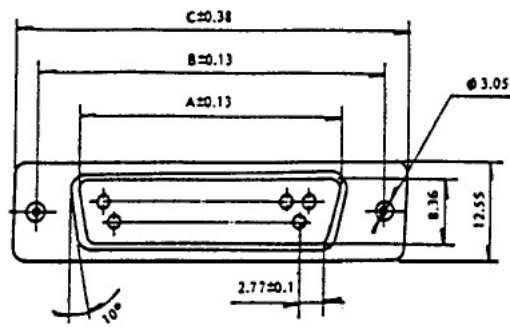

Figure A.3 DB37 Female

POSITION	A	B	C	D	E	F
62 Pin	55.42	63.50	69.32	1.98	8.36	12.55

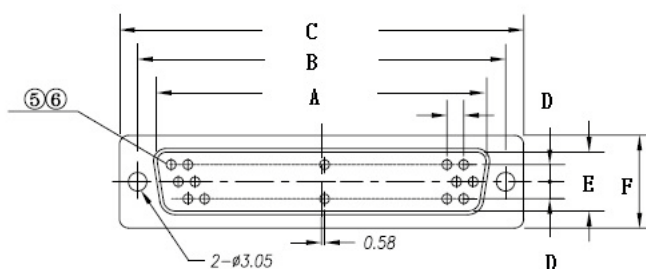

Figure A.4 DB62 Female

POSITION	A	B	C	D1	D2	E	F
78 Pin	67.16±0.38	61.11±0.25	52.40±0.20	2.41	2.08	10.72±0.25	14.1±0.25

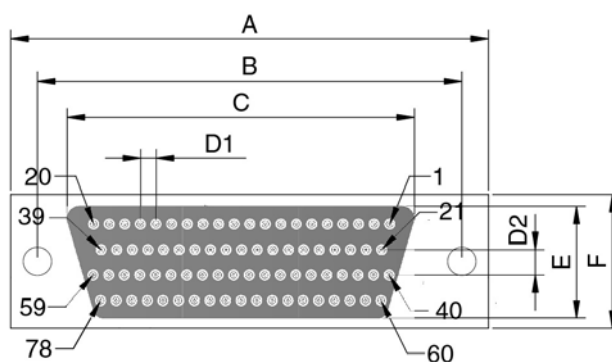

Figure A.5 DB78 Female

ADVANTECH

Enabling an Intelligent Planet

www.advantech.com

Please verify the specifications before quoting. This guide is intended for reference purposes only.

All product specifications are subject to change without notice.

No part of this publication may be reproduced in any form (e.g., electronically) or by any means (e.g., photocopying, recording, or otherwise) without prior written permission from the publisher.

All brand and product names are trademarks or registered trademarks of their respective companies.

© Advantech Co., Ltd. 2018