

User Manual

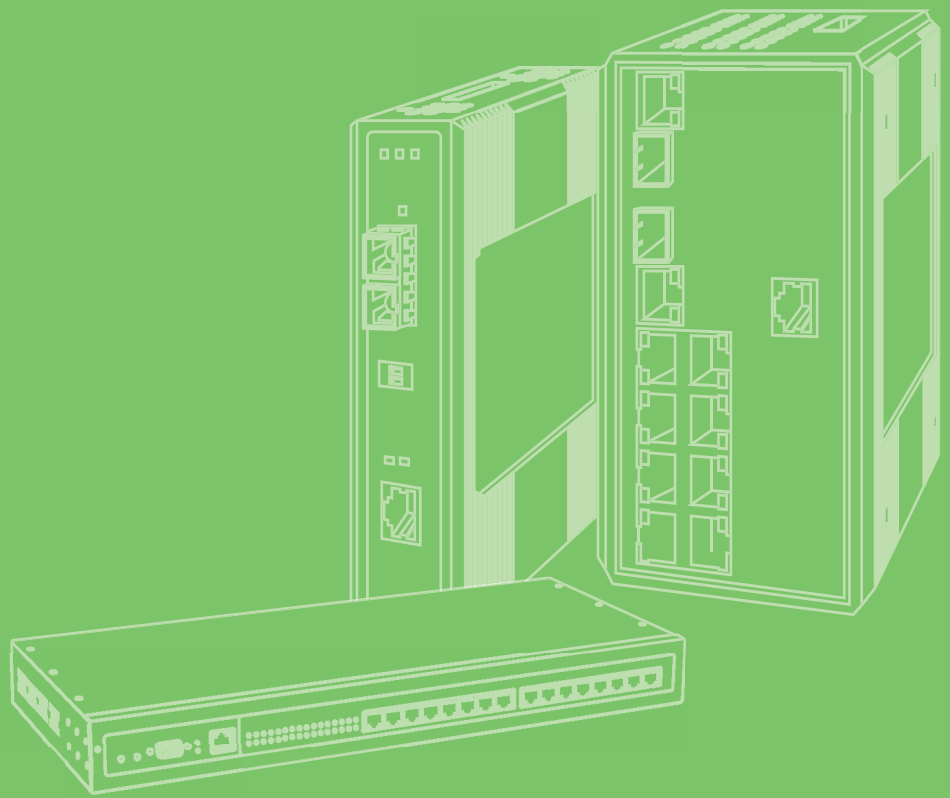

EKI-1511X/1512X

1/2-port RS-422/485 Serial
Device Servers

ADVANTECH

Enabling an Intelligent Planet

Copyright

The documentation and the software included with this product are copyrighted 2016 by Advantech Co., Ltd. All rights are reserved. Advantech Co., Ltd. reserves the right to make improvements in the products described in this manual at any time without notice. No part of this manual may be reproduced, copied, translated or transmitted in any form or by any means without the prior written permission of Advantech Co., Ltd. Information provided in this manual is intended to be accurate and reliable. However, Advantech Co., Ltd. assumes no responsibility for its use, nor for any infringements of the rights of third parties, which may result from its use.

Acknowledgements

All other product names or trademarks are properties of their respective owners.

Product Warranty (5 years)

Advantech warrants to you, the original purchaser, that each of its products will be free from defects in materials and workmanship for five years from the date of purchase.

This warranty does not apply to any products which have been repaired or altered by persons other than repair personnel authorized by Advantech, or which have been subject to misuse, abuse, accident or improper installation. Advantech assumes no liability under the terms of this warranty as a consequence of such events.

Because of Advantech's high quality-control standards and rigorous testing, most of our customers never need to use our repair service. If an Advantech product is defective, it will be repaired or replaced at no charge during the warranty period. For out-of-warranty repairs, you will be billed according to the cost of replacement materials, service time and freight. Please consult your dealer for more details.

If you think you have a defective product, follow these steps:

1. Collect all the information about the problem encountered. (For example, CPU speed, Advantech products used, other hardware and software used, etc.) Note anything abnormal and list any onscreen messages you get when the problem occurs.
2. Call your dealer and describe the problem. Please have your manual, product, and any helpful information readily available.
3. If your product is diagnosed as defective, obtain an RMA (return merchandise authorization) number from your dealer. This allows us to process your return more quickly.
4. Carefully pack the defective product, a fully-completed Repair and Replacement Order Card and a photocopy proof of purchase date (such as your sales receipt) in a shippable container. A product returned without proof of the purchase date is not eligible for warranty service.
5. Write the RMA number visibly on the outside of the package and ship it prepaid to your dealer.

Declaration of Conformity

CE

This product has passed the CE test for environmental specifications when shielded cables are used for external wiring. We recommend the use of shielded cables. This kind of cable is available from Advantech. Please contact your local supplier for ordering information.

FCC Class A

Note: This equipment has been tested and found to comply with the limits for a Class A digital device, pursuant to part 15 of the FCC Rules. These limits are designed to provide reasonable protection against harmful interference when the equipment is operated in a commercial environment. This equipment generates, uses, and can radiate radio frequency energy and, if not installed and used in accordance with the instruction manual, may cause harmful interference to radio communications. Operation of this equipment in a residential area is likely to cause harmful interference in which case the user will be required to correct the interference at his own expense.

FCC Class B

This equipment has been tested and found to comply with the limits for a Class B digital device, pursuant to part 15 of the FCC Rules. These limits are designed to provide reasonable protection against harmful interference in a residential installation. This equipment generates, uses and can radiate radio frequency energy and, if not installed and used in accordance with the instructions, may cause harmful interference to radio communications. However, there is no guarantee that interference will not occur in a particular installation. If this equipment does cause harmful interference to radio or television reception, which can be determined by turning the equipment off and on, the user is encouraged to try to correct the interference by one or more of the following measures:

- Reorient or relocate the receiving antenna.
- Increase the separation between the equipment and receiver.
- Connect the equipment into an outlet on a circuit different from that to which the receiver is connected.
- Consult the dealer or an experienced radio/TV technician for help.

Technical Support and Assistance

1. Visit the Advantech web site at www.advantech.com/support where you can find the latest information about the product.
2. Contact your distributor, sales representative, or Advantech's customer service center for technical support if you need additional assistance. Please have the following information ready before you call:
 - Product name and serial number
 - Description of your peripheral attachments
 - Description of your software (operating system, version, application software, etc.)
 - A complete description of the problem
 - The exact wording of any error messages

Safety Instructions

1. Read these safety instructions carefully.
2. Keep this User Manual for later reference.
3. Disconnect this equipment from any AC outlet before cleaning. Use a damp cloth. Do not use liquid or spray detergents for cleaning.
4. For plug-in equipment, the power outlet socket must be located near the equipment and must be easily accessible.
5. Keep this equipment away from humidity.
6. Put this equipment on a reliable surface during installation. Dropping it or letting it fall may cause damage.
7. The openings on the enclosure are for air convection. Protect the equipment from overheating. **DO NOT COVER THE OPENINGS.**
8. Make sure the voltage of the power source is correct before connecting the equipment to the power outlet.
9. Position the power cord so that people cannot step on it. Do not place anything over the power cord.
10. All cautions and warnings on the equipment should be noted.
11. If the equipment is not used for a long time, disconnect it from the power source to avoid damage by transient overvoltage.
12. Never pour any liquid into an opening. This may cause fire or electrical shock.
13. Never open the equipment. For safety reasons, the equipment should be opened only by qualified service personnel.
14. If one of the following situations arises, get the equipment checked by service personnel:
 - The power cord or plug is damaged.
 - Liquid has penetrated into the equipment.
 - The equipment has been exposed to moisture.
 - The equipment does not work well, or you cannot get it to work according to the user's manual.
 - The equipment has been dropped and damaged.
 - The equipment has obvious signs of breakage.
15. **DO NOT LEAVE THIS EQUIPMENT IN AN ENVIRONMENT WHERE THE STORAGE TEMPERATURE MAY GO BELOW -40° C (-4° F) OR ABOVE 85° C (185° F). THIS COULD DAMAGE THE EQUIPMENT. THE EQUIPMENT SHOULD BE IN A CONTROLLED ENVIRONMENT.**

16. CAUTION: DANGER OF EXPLOSION IF BATTERY IS INCORRECTLY REPLACED. REPLACE ONLY WITH THE SAME OR EQUIVALENT TYPE RECOMMENDED BY THE MANUFACTURER, DISCARD USED BATTERIES ACCORDING TO THE MANUFACTURER'S INSTRUCTIONS.

Disclaimer

Information in this document is subject to change without notice and does not represent a commitment on the part of Advantech or any of its subsidiaries.

Advantech provides this document "as is," without warranty of any kind, either expressed or implied, including, but not limited to, the implied warranties of, fitness or merchantability for a particular purpose. Advantech may make improvements and/or changes in this manual or in the product(s) and/or the program(s) described in this manual at any time.

This document could include technical inaccuracies or typographical errors. Changes are made periodically to the information herein; these changes may be incorporated in new editions of the publication.

Contents

Chapter 1	Overview	1
1.1	Introduction	2
1.2	Features	2
1.3	Specification	2
1.4	Packing List	3
Chapter 2	Getting Started	5
2.1	Understanding the Advantech EKI-1510X Series	6
2.1.1	Network Architecture	6
2.1.2	LED Indicators	6
	Table 2.1: EKI-1510 Series LED Definition	6
2.1.3	Dimensions (Unit: mm)	7
2.2	Connecting the Hardware	9
2.2.1	Physical Mounting	9
2.2.2	Network Connection	9
2.2.3	Power Connection	10
2.2.4	Serial Connection	10
2.3	Configuration Utility Installation	11
Chapter 3	Configuration	15
3.1	Advantech EKI Device Configuration Utility overview	16
3.2	Discovering Your Serial Device Server	17
3.2.1	Auto Searching	17
3.2.2	Cleaning the Device List and Searching Again	18
3.2.3	Manual Appending	18
3.3	Setting Ethernet Parameters	19
3.4	Setting Serial Parameters	21
3.4.1	Basic Configuration	22
3.5	Operation Mode Configuration	22
3.5.1	Virtual COM Mode	22
3.5.2	Data Mode (USDG Mode)	25
3.5.3	Control Mode (USDG Mode)	29
3.5.4	Control Mode Command List	30
3.6	Advanced Settings	31
3.7	Security Configuration	33
3.7.1	Accessible Function	33
3.8	Port Monitor	34
3.9	Administrator Settings	35
3.9.1	Import/Export Device Setting	35
3.9.2	Import/Export Serial Port Setting	35
3.9.3	Locate the Serial Device Server	35
3.9.4	Lock the Serial Device Server (Password Protection)	36
3.9.5	Restore to Factory Default Setting	37
3.9.6	Update firmware	38
Chapter 4	Setting COM Redirector	39
4.1	Setting COM Redirector (Virtual COM port)	40
4.1.1	Auto Mapping	40
4.1.2	Manual Mapping	42

	4.1.3	Manual Direct Mapping Virtual COM Port.....	43
	4.1.4	Remove the Virtual COM Port	44
Chapter	5	Web-Based Configuration.....	45
	5.1	Overview	46
	5.2	Accessing the Web Page.....	46
	5.3	System	47
	5.4	Network Configuration	48
	5.5	Port Configuration	48
	5.6	Monitor	50
	5.7	Auto Warning (Alarm)	52
	5.8	Change Password.....	53
	5.9	Import/Export Device Settings	53
	5.10	Reboot	54
Chapter	6	Telnet Configuration.....	57
	6.1	Overview	58
	6.2	Command List.....	58
		Table 6.1: Console Command List.....	58
Appendix A		List of Known TCP and UDP Port Numbers	65
	A.1	List of Known TCP and UDP Port Numbers	66

Chapter 1

Overview

1.1 Introduction

Advantech's EKI-1511X, EKI-1512X series of Industrial Device Servers is a robust, feature-rich, and cost effective way to network-enable equipment in an industrial automation environment. EKI-1510X series provides one or two RS-422/485 serial ports.

By encapsulating serial data and transporting it over Ethernet, the EKI-1510X series allows virtual serial links over Ethernet and IP (TCP/IP, UDP/IP) networks. After mapped VCOM (Virtual COM) port with Advantech EKI Device Configuration Utility, standard serial operation calls are transparently redirected to the serial device servers, guaranteeing compatibility with legacy serial device and enabling backward compatibility with existing software.

1.2 Features

- Up to 4096 serial ports on single host
- Supports 10/100 Mbps auto-sensing Ethernet port
- Supports any baud rate setting up to 921.6 Kbps
- Allows max. of 5 hosts to access one serial port simultaneously with VCOM operation mode.
- EMC level 3 protection
- Compact, slim designed metal case
- Terminal block connector for easy wiring

1.3 Specification

LAN

- **Compatibility:** IEEE 802.3, IEEE 802.3u
- **Speed:** 10/100 Mbps, auto-sensing
- **No. of Ports:** 1
- **Port Connector:** RJ-45
- **Protection:** Built-in 1.5 KV magnetic isolation

Serial Communications

- Port Type: RS-422/485
- No. of Ports: EKI-1511X: 1
EKI-1512X: 2
- Port Connector: Terminal Block
- Data Bits: 5, 6, 7, 8
- Stop Bits: 1, 1.5, 2
- Parity Bits: None, Odd, Even, Space, Mark
- Flow Control: XON/XOFF
- Baud Rate: 300 bps to 921.6 Kbps
- Serial Signals: RS-422: TxD+, TxD-, RxD+, RxD-, GND
RS-485: Data+, Data-, GND
- Protection: 15KV ESD protection for all signals
Enclosure Contact 6KV
Enclosure Air: 8KV
EFT: 1KV
Surge: 2KV

Software

- Driver Support: Windows XP/7/8/8.1, Windows Server 2008/2012/2012 R2
- Utility Software: EKI Device Configuration Utility
- Operation Modes: COM port redirection mode (Virtual COM)
 - TCP/UDP server mode
 - TCP/UDP client mode
 - Pair connection (peer to peer) mode
- Configuration Methods: Windows Utility, and Web Browser

Mechanics

- Dimensions (H x W x D): 85 x 120 x 26 mm (3.35" x 4.72" x 1.02")
- Enclosure: Metal with solid mounting hardware
- Mounting: Wall
- Weight: EKI-1511X: 250g
EKI-1522X: 275g

General

- LED Indicators: System: Power, Status
LAN: Speed, Link/Active
Serial: Tx, Rx

Power Requirements

- Power Input: 10 to 30 VDC
- Power Consumption: 1.5 W
- Power Line Protection: 1 KV burst (EN61000-4-4)
0.5 KV surge (EN61000-4-5)

Regulatory Approvals

- EMC: CE, FCC Part 15 Subpart B (Class A)

1.4 Packing List

- 1 x EKI-1511X/1512X Serial Device Server
- CD-ROM for utility
- Mounting Kit

Chapter 2

Getting Started

In this chapter, you will be given an overview of the EKI-1510X series hardware installation procedures.

2.1 Understanding the Advantech EKI-1510X Series

The EKI-1510X is an advanced series of device servers. They extend traditional COM ports of a PC with access over a TCP/IP network. Through networking, you can control and monitor remote serial devices either over a LAN or over the WAN. Since the EKI-1510X series is connected through a TCP/IP networks, you will need to know some basic facts about networking in order to get the server hooked up correctly.

2.1.1 Network Architecture

Tradition serial port communication uses a COM port board that slides into one of the slots at the back of your PC. In this case, only the computer containing the board can access the serial port. With the EKI-1510X series, you are now able to access the COM port from a distance through local area network. The EKI-1510X series can be integrated within the network architecture of any protocol.

Note! All devices in the series which are connected to the port must have the same protocol running and the same transmission speed. Connect devices running different protocols to different ports of the EKI-1510X series.



2.1.2 LED Indicators

There are three or four LEDs located on the top panel of the EKI-1510X series, each with its own specific functions.

Table 2.1: EKI-1510 Series LED Definition

LED	Color	Status	Description
Status/Power	Green	ON	Heartbeat (1 time/sec)
		OFF	Not working
	Red	ON	Power ON
		OFF	Power OFF
Speed/Link (Act)	Green	ON	100 Mbps speed
		OFF	10 Mbps speed
	Red	ON	Valid network link
		OFF	Invalid network link
Tx/Rx (Serial)	Green	ON	Data being transmitted
		OFF	No data being transmitted
	Red	ON	Data being received
		OFF	No Data being received

2.1.3 Dimensions (Unit: mm)

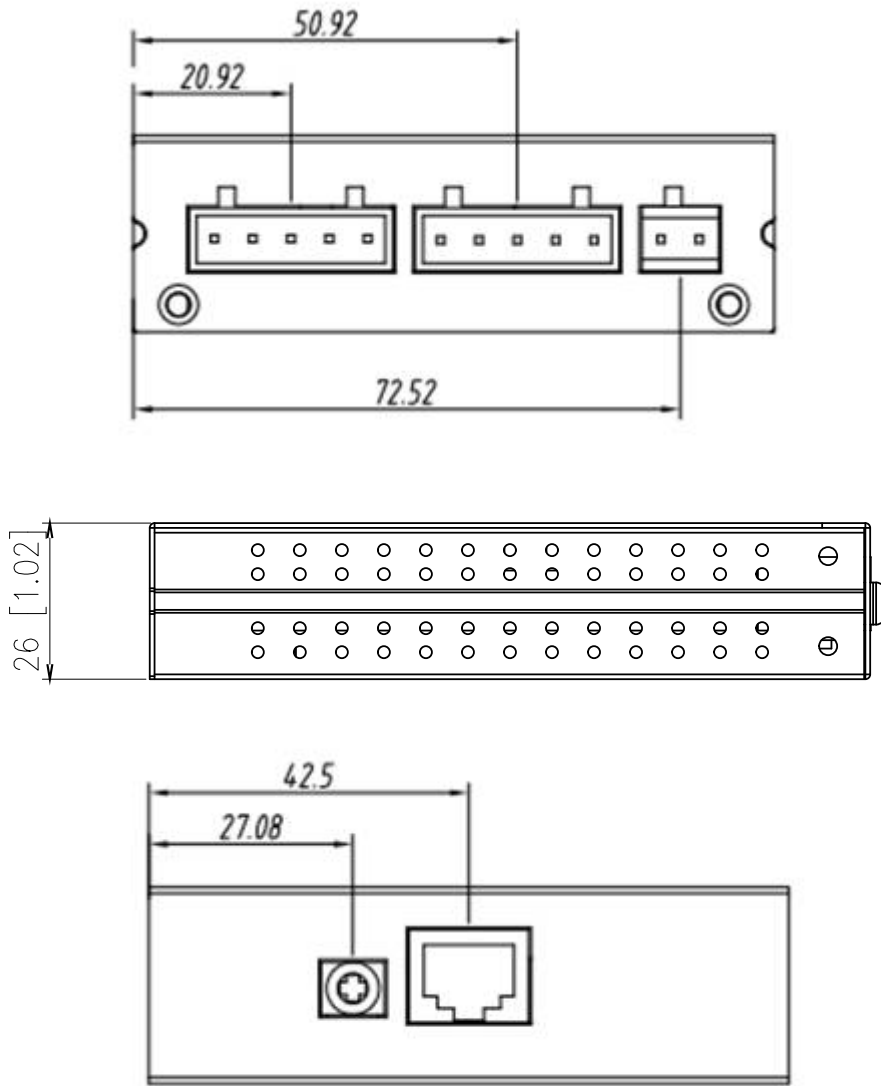

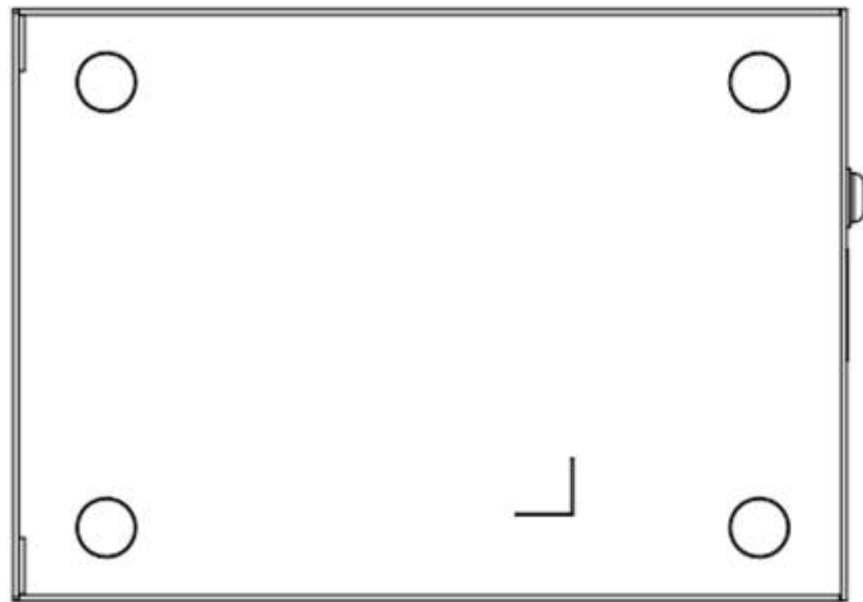
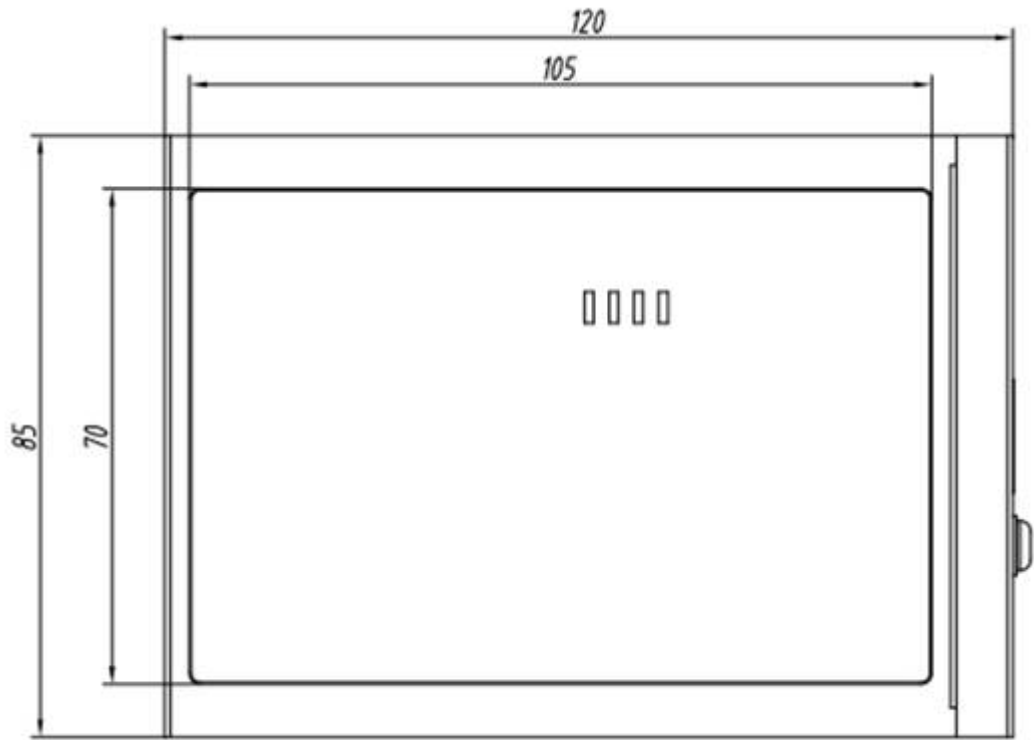

2.2 Connecting the Hardware

Next, we will explain how to find a proper location for your serial device server, and then explain how to connect to the network, hook up the power cable, and connect to the EKI-1510X series's serial port.

2.2.1 Physical Mounting

After attaching the mounting kit, you can install the EKI-1510X series serial device server onto a flat wall surface, and choose the correct screw according the material of your mounting position.

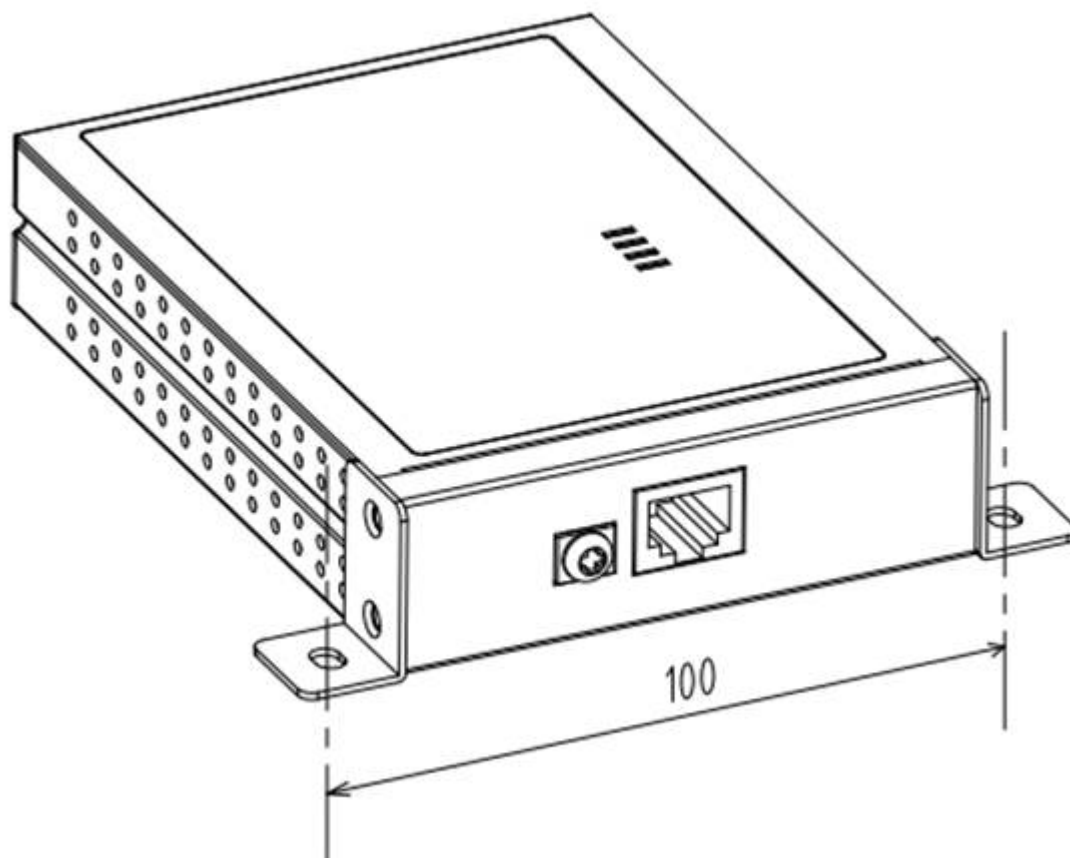

2.2.2 Network Connection

To use the 10/100Base-T Ethernet connector located on the EKI-1510X series, you will simply plug one end of your Ethernet cable into the 10/100Base-T connector, and the other end into the hub/switch connected to your network or direct connect to your PC.

Cabling requirements for the Ethernet

Use an RJ-45 to connect the Ethernet port of the EKI-1510X series to the network hub. The cable for connection should be above Category 3 (for 10Mbps data rate) or Category 5 (for 100Mbps data rate) UTP/STP cable, which is compliant with EIA/TIA 586 specifications. EKI-1510X series can be connected to other hubs or switches through a twisted-pair straight through the cable or a crossover cable up to 100m long.

2.2.3 Power Connection

1. Insert the power wire from DC power supply into the power contacts of the terminal lock connector on the EKI device.
2. Tighten the terminal screws to prevent the DC wires coming loose.
3. Switch on the DC power supply.

If the EKI-1510X series is working properly, the green power LED will light up, indicating that the EKI-1510X series is receiving power.

2.2.4 Serial Connection

The EKI-1510X series has terminal block design for RS-422/485 serial port support. With terminal block, you can wire the physical cable into relative contacts easily.

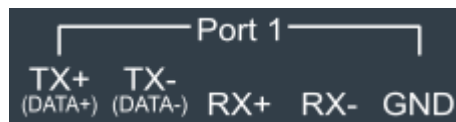

2.3 Configuration Utility Installation

The following section will demonstrate installing the Advantech serial device server configuration utility, a tool to set up and monitor the EKI-1510 series serial device servers.:

Note! Be sure that you have Microsoft .NET Framework 2.0 installed on your PC.



1. Execute the EKI device configuration utility setup program with administrator privilege that could be found in the CD-ROM shipped with the product or downloaded from official support site.
2. Upon executing the setup program, the Welcome Dialog Box will pop-up. Press the “Next” button to continue.

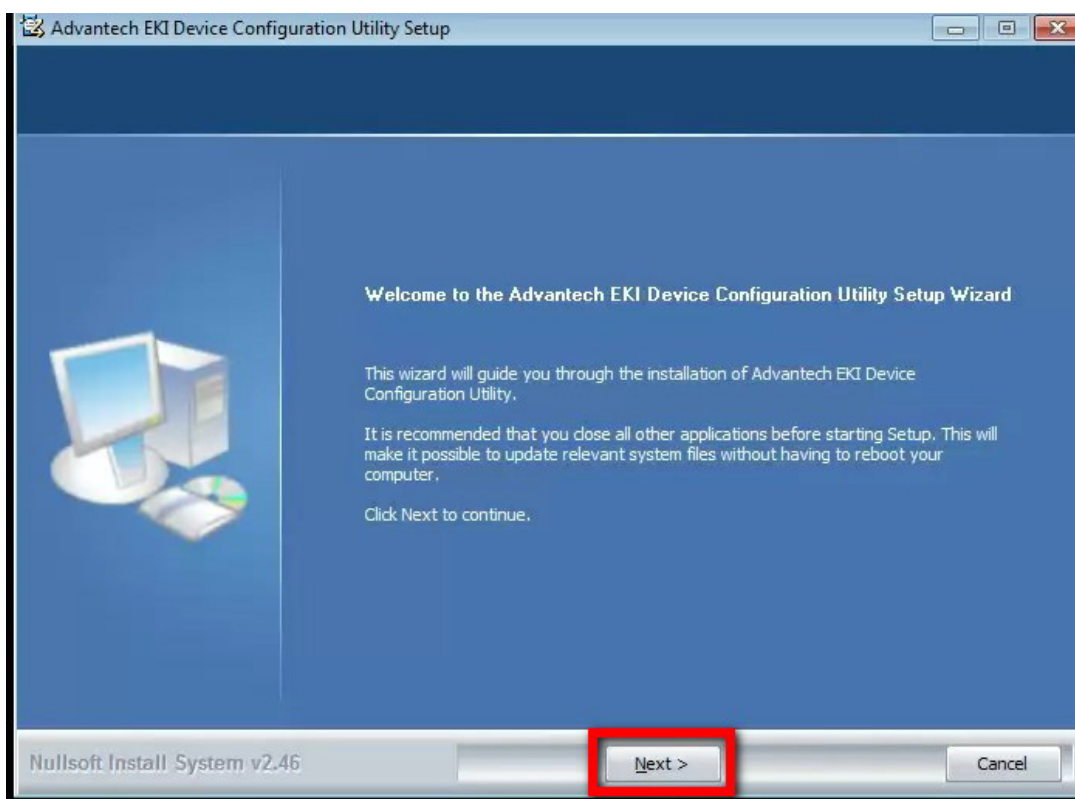

- Carefully read the Software License Agreement and press "I Agree" to continue.

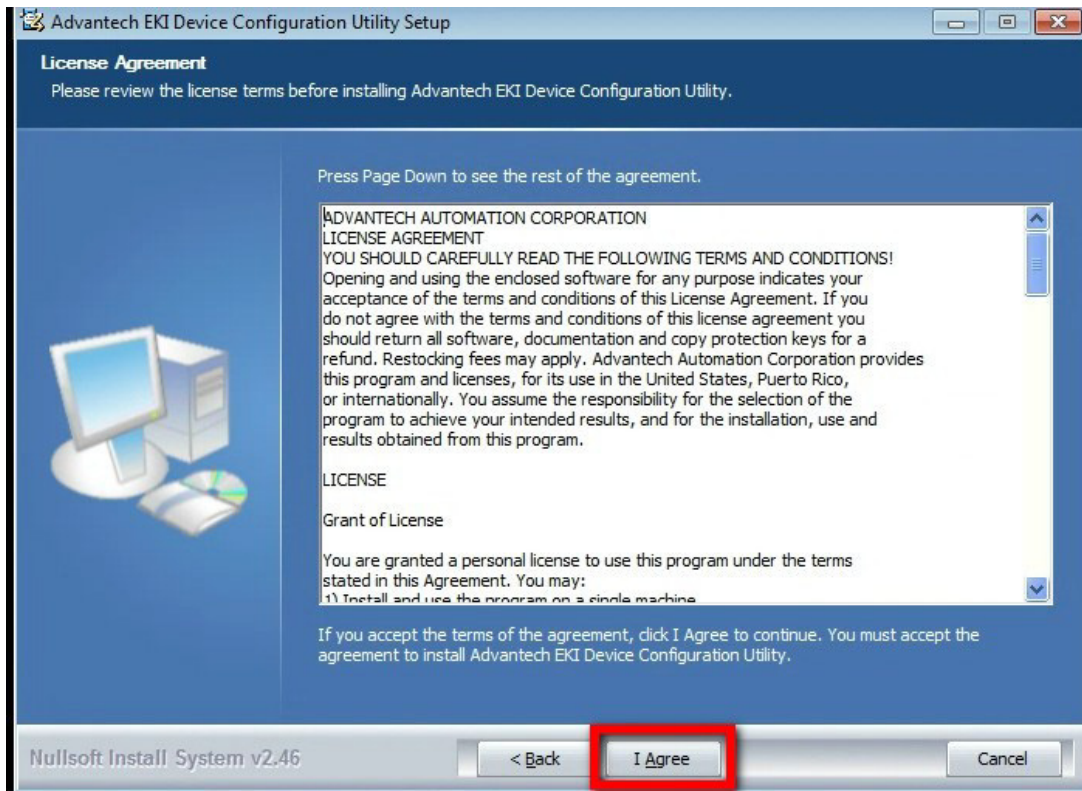

- The setup program will install the relative files into the default path that system assigned.

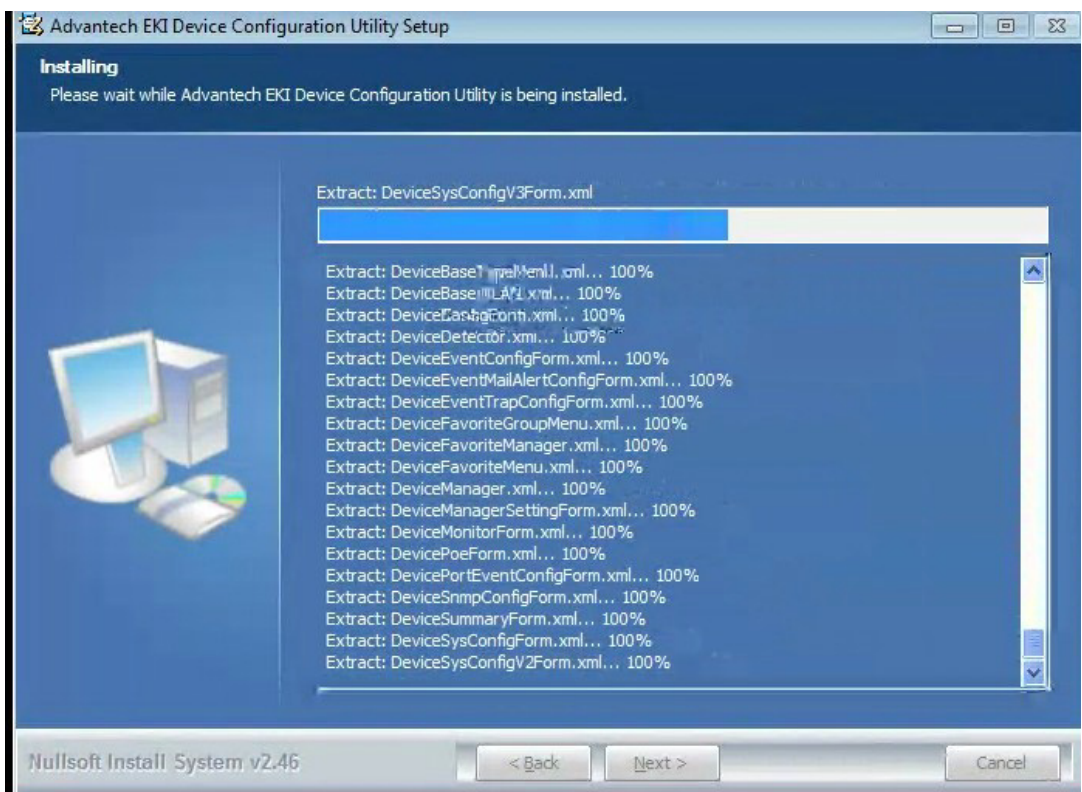

5. After setup program has copied all program files to your computer, click the “Finish” button to finish the installation.

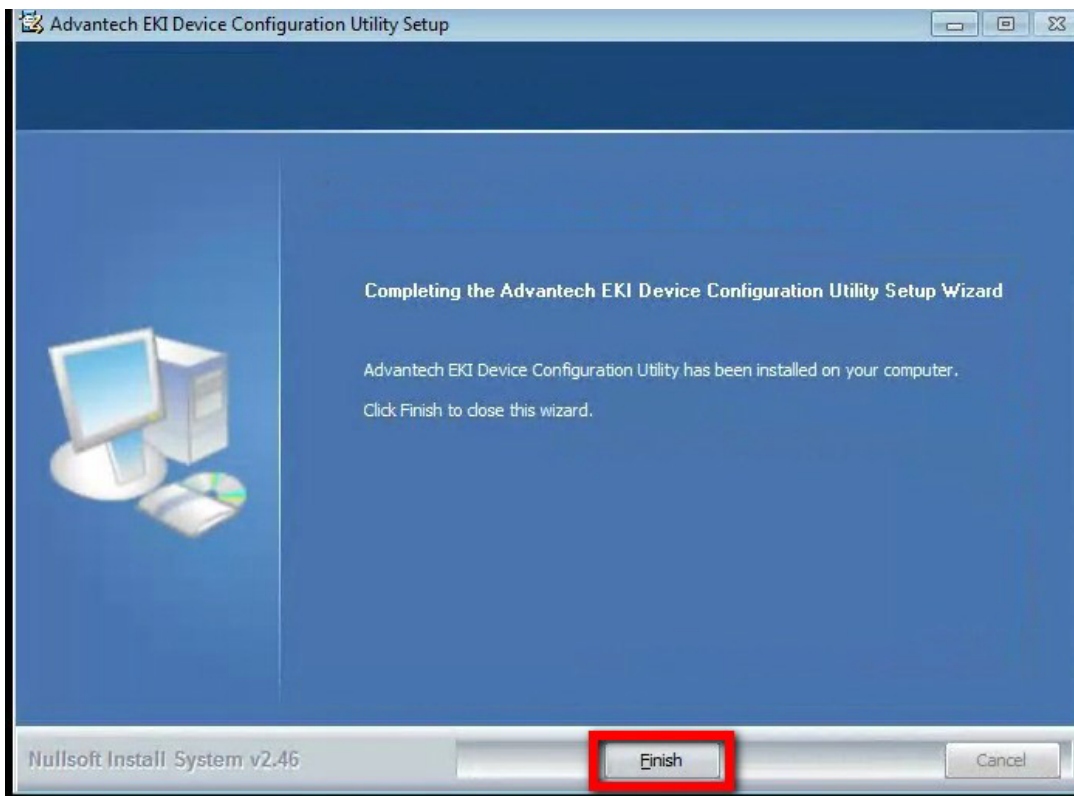

Chapter 3

Configuration

3.1 Advantech EKI Device Configuration Utility overview

Advantech provides an easy-to-use configuration utility to configure your EKI-1510X series serial device server through an Ethernet connection. For secure administration, you can lock up the devices with password. After locking with the password, only the persons who know the password can configure the password protected device. If you lose the password, re-initializing the device is the only way to recover it.

The EKI Device Configuration Utility is an excellent device management tool. You also need this tool to map a virtual COM port on the PC. With this utility, you can:

- Configure the network settings (you can set the IP address, Gateway address, and Subnet mask)
- Perform diagnostic tests
- Perform administrative functions
- Configure virtual COM port

There are four major areas in the serial device server configuration utility.

1. Device List Area: All devices that could be managed by the utility will be searched and listed in this area. You can arrange different groups and virtual COM ports.
2. Device Information Area: When clicking on the device or moving cursor on device, the related information will be shown on this area for quick examination.
3. Configuration Area: Click on the item on the device list area, the related configuration page will display on the area.
4. Quick Toolbar: Useful management functions shortcut for quick access.

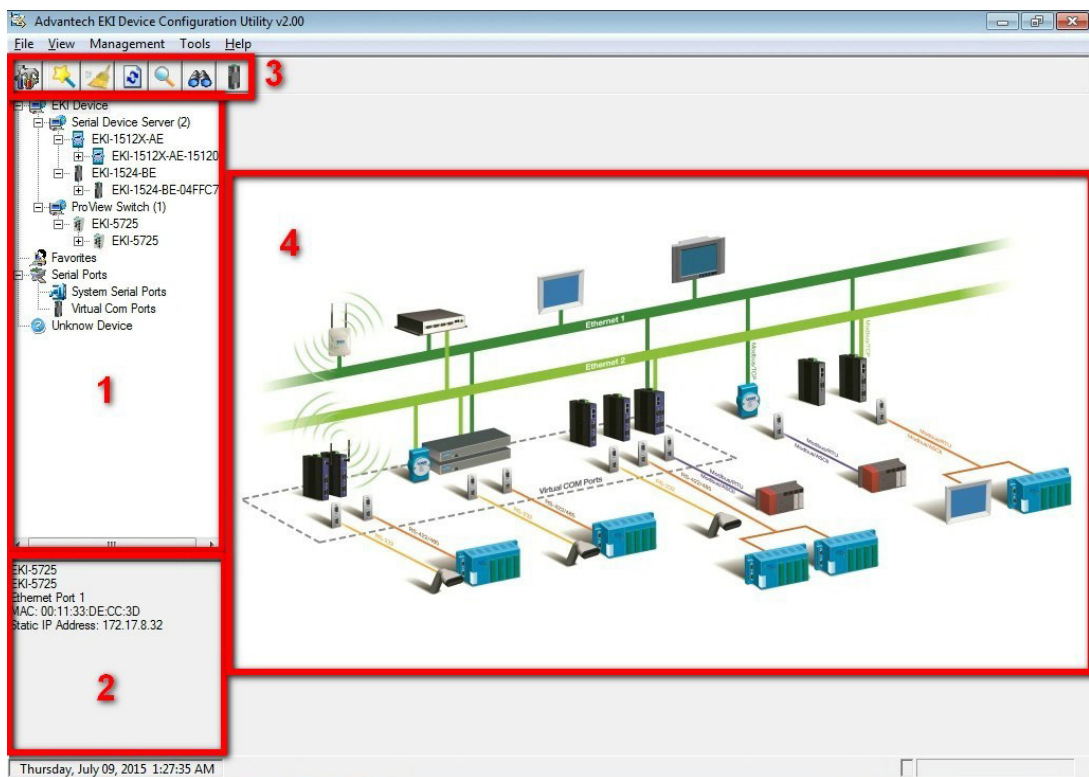

Note! Reserve TCP/UDP port 5048 and 5058 in your Ethernet network, configuration utility will use these ports to communicate with Advantech Devices.





3.2 Discovering Your Serial Device Server

3.2.1 Auto Searching

Advantech's EKI Device Configuration Utility will automatically search all the supported devices periodically, and show on the Device List Area of the utility. The utility provides an auto-search function to show your devices by simply executing the configuration utility program from the Start Menu.

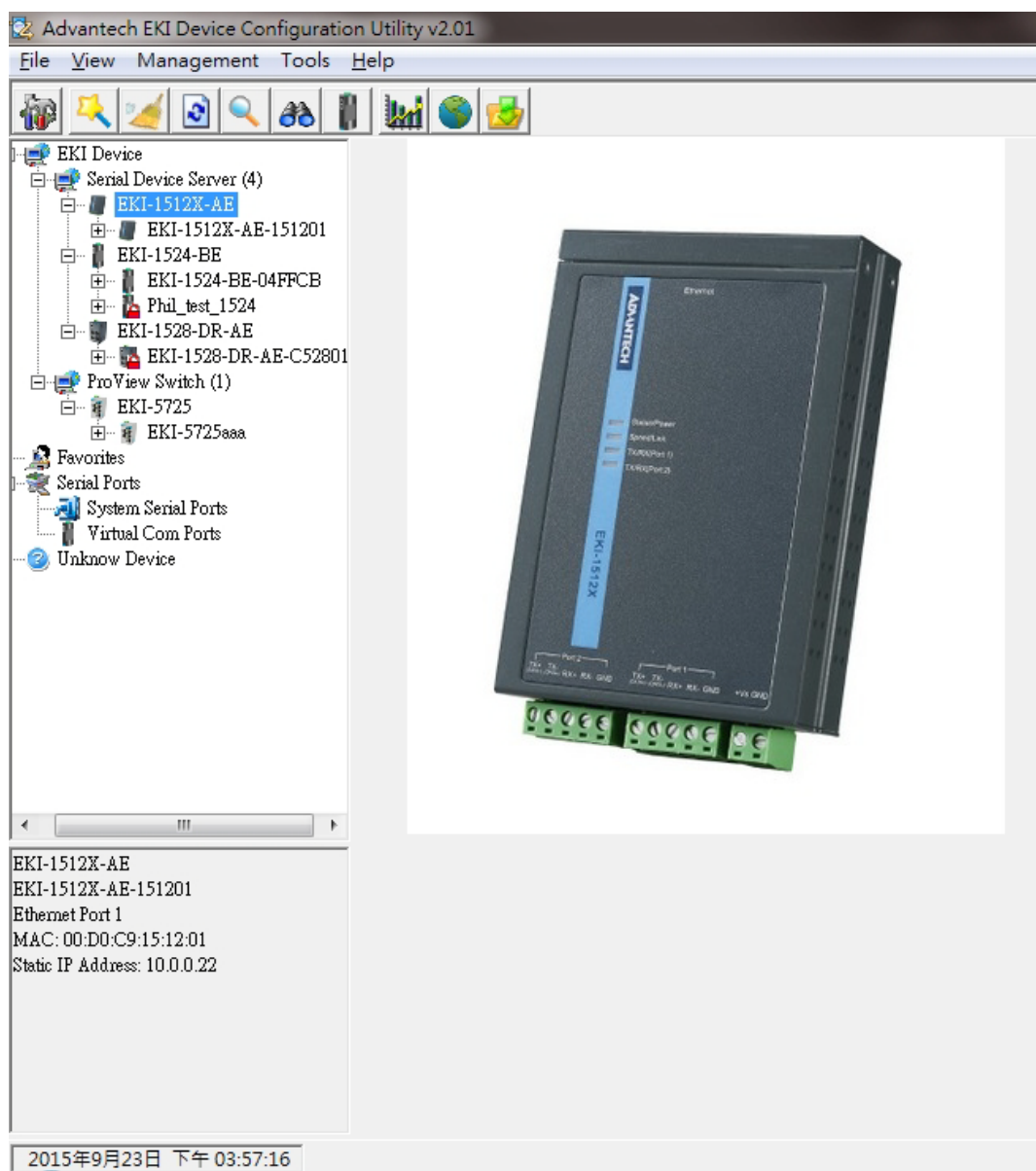
From here all device on the same network domain will be searched and display on Device List Area.



Note!  When you check a device for the first time with factory default setting, the default device name is “MAC ID”. In this case, the device name “EKI-1512X-AE-151201” means the latest 3 “MAC ID” of device is “15 12 01”. You can change the default device name in System Tab of Device Properties.

3.2.2 Cleaning the Device List and Searching Again



You can click the  button on the “Quick Toolbar”. The utility will clear all listed devices in the Device List Area and re-search again.



You can click the  button on the “Quick Toolbar”. The utility will search for devices again without cleaning the device list.

3.2.3 Manual Appending

Using “Add IP address to Favorite” or “Search a Range of IP addresses” function, you are able to add on device or group of devices to “Favorites”. These devices can be located on the local network domain or other network domain.

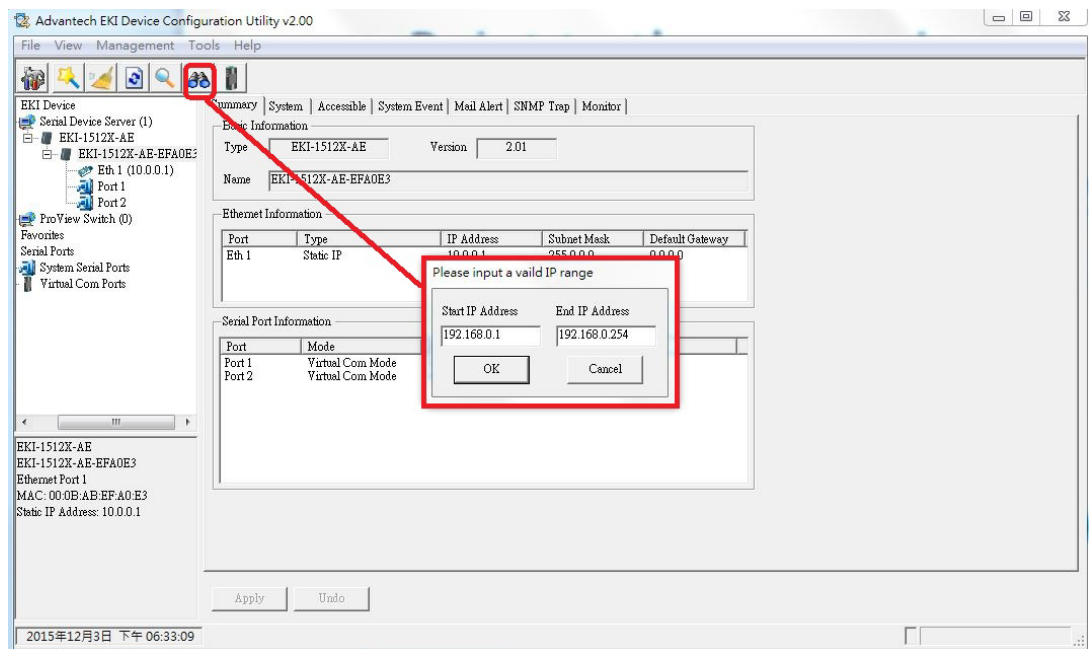

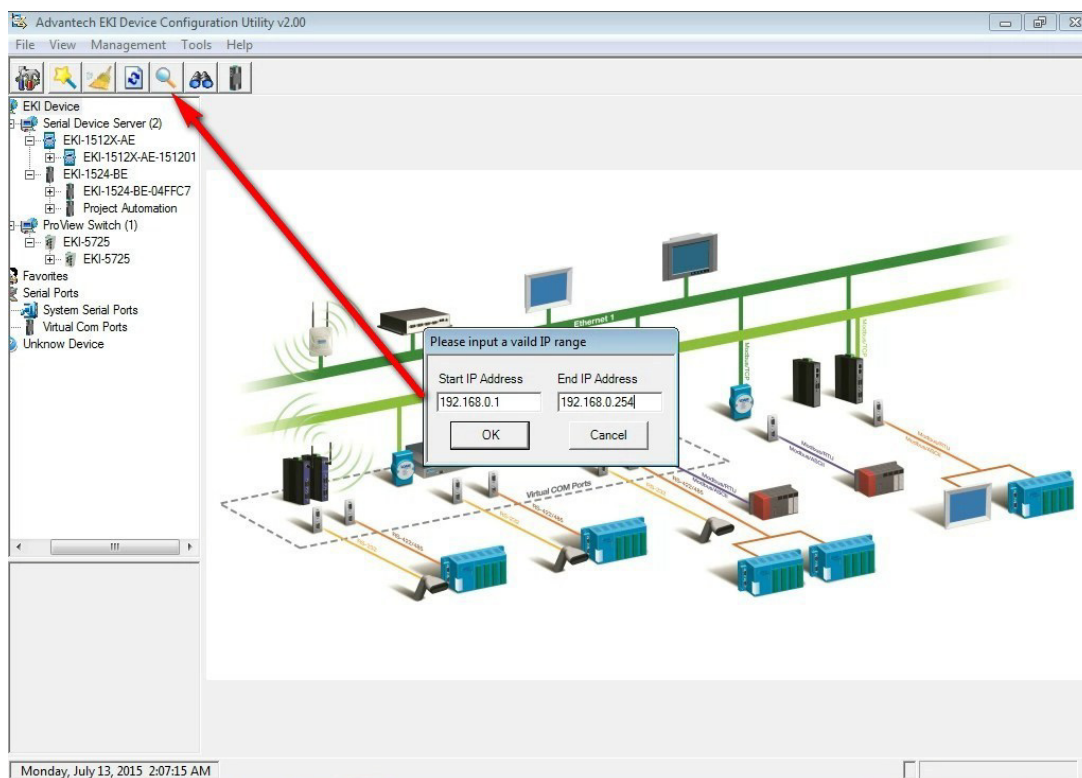

3.3 Setting Ethernet Parameters

This section explains how to configure the device network with configuration utility. Click on the Ethernet interface node under the device node. The Ethernet configuration page will be shown in the Configuration Area.

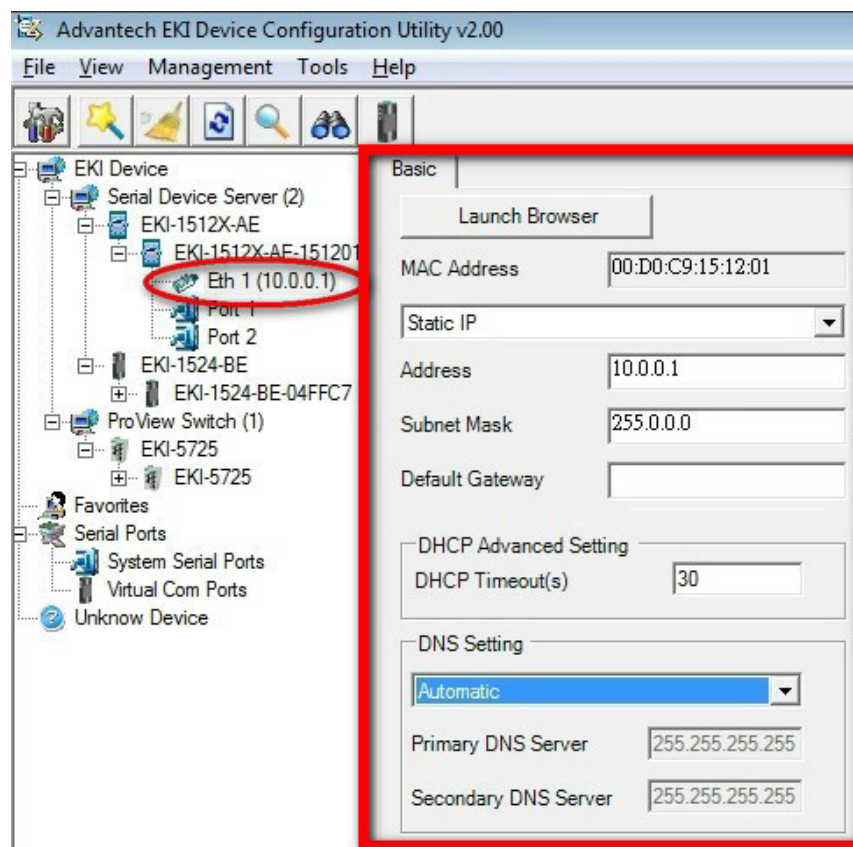

MAC Address:

The MAC address is for the local system to identify and locate each device. This MAC address is already set before delivery from factory, hence no need for further configuration.

IP Address, Subnet Mask, Default Gateway:

The IP address identifies your Advantech serial device server on the global network. Each EKI-1510 series has the same default IP address 10.0.0.1. Obtain these specific IP addresses from your network administrator and then configure each Advantech serial device server with individual IP addresses, related Subnet Mask and Gateway Setting.

You can choose from four possible IP configure modes: Static, DHCP, BOOTP, and DHCP/BOOTP.

Basic

Launch Browser

MAC Address 00:D0:C9:15:12:01

Static IP

Static IP

DHCP + Auto-IP

Bootp + Auto-IP

DHCP + Bootp + Auto-IP

Default Gateway

DHCP Advanced Setting

DHCP Timeout(s) 30

DNS Setting

Automatic

Primary DNS Server 255.255.255.255

Secondary DNS Server 255.255.255.255

Static IP

User defines IP address, Subnet Mask, Default Gateway, and DNS.

DHCP + Auto-IP

DHCP server assigns IP address.

Bootp + Auto-IP

Bootp server assigns IP address.

DHCP + Bootp + Auto-IP

DHCP server assigns IP address, Subnet Mask, Default Gateway, and DNS or Bootp server assigns IP address (If DHCP server does not respond).

DNS Setting

In order to use the DNS feature, you need to set the IP address of DNS server to be able to access the host with the domain name. The device provides Primary DNS server and Secondary DNS server configuration items to set the IP address of the DNS server. Secondary DNS server is included for use when Primary DNS sever is unavailable.

DHCP Timeouts

If you select DHCP as IP configuration mode, the device will retry getting DHCP response before timeouts until network settings are assigned by the DHCP server. If the DHCP/BOOTP server is unavailable, the device will use Address auto configuration (based on RFC 3330 and RFC 3927) for IP setting.

Note! *When you have finished the configuration of these settings for each category, please press the “Apply” button in order to make these settings effective on the Serial Device Server. (Will reboot your Serial Device Server)*



3.4 Setting Serial Parameters

This section explains how to configure the serial communication parameters of serial device server using this utility. There have various operation modes that are suitable for different applications.

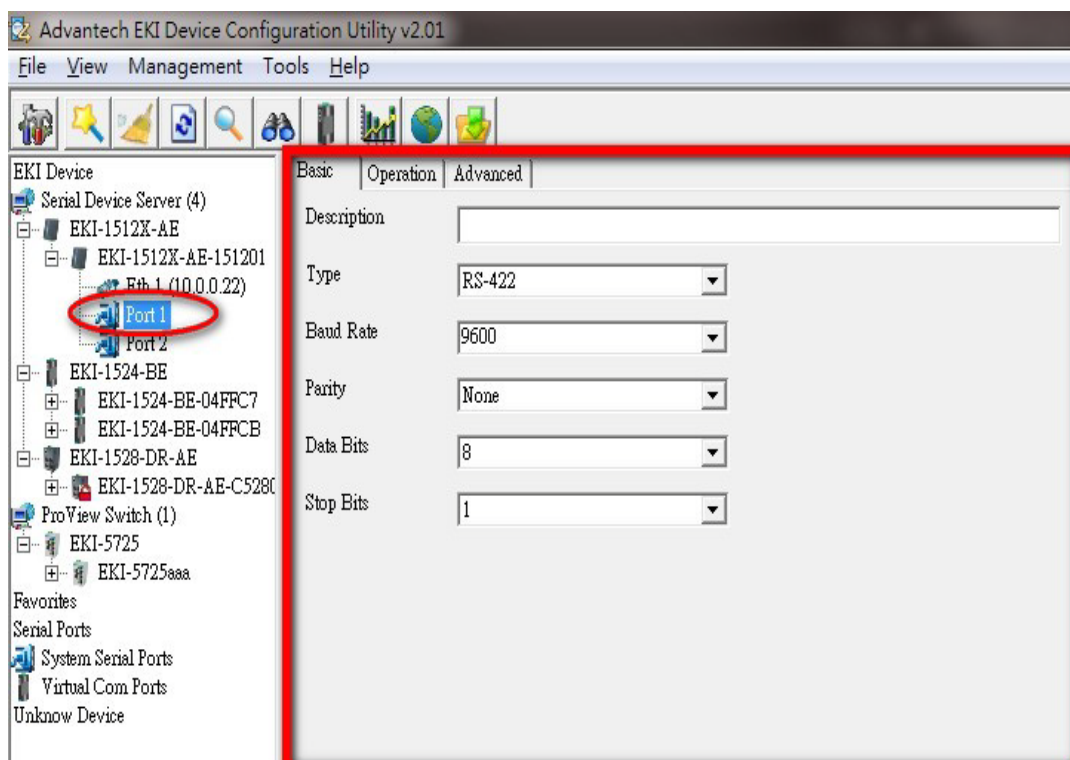

3.4.1 Basic Configuration

Description:

You can give a more detailed description on the function of the port for easier management and maintenance. Descriptions have a limit of 128 characters.

Baud Rate:

The device supports baud rate from 300 to 921.6Kbps. While setting the baud rate, please note that the value should conform to the current transmission speeds of connected devices.

Parity:

The device provides 5 options: None, Odd, Even, Space, and Mark.

Data Bits:

The device provides four options: 5, 6, 7 and 8.

Stop Bits:

The device provides three options: 1, 1.5 and 2.

3.5 Operation Mode Configuration

3.5.1 Virtual COM Mode

The Advantech serial device servers extend traditional COM ports of a PC to Ethernet access. Through Ethernet networking, users can control and monitor remote serial devices and equipment over LAN or WAN.

Advantech serial device servers come with a COM port redirector (Virtual COM driver) that transmits all serial signals intact. This means that your existing COM-based software can be preserved, without modifying to fulfill the needs. The Virtual COM mode allows user to continue using serial communications software that was written for pure serial communication applications.

The device comes with COM port redirector (virtual COM driver) that works. The driver establishes a transparent connection between host and serial device by mapping the IP of Advantech serial device server serial port to a local COM port on the host computer.

The device provides Multi-access function through Ethernet connection path. Allow the maximum of 5 connections to open one serial port simultaneously. In this mode, all connection has to use the same serial setting. If one serial setting of these connections is different from others, the data communication may operate incorrectly.

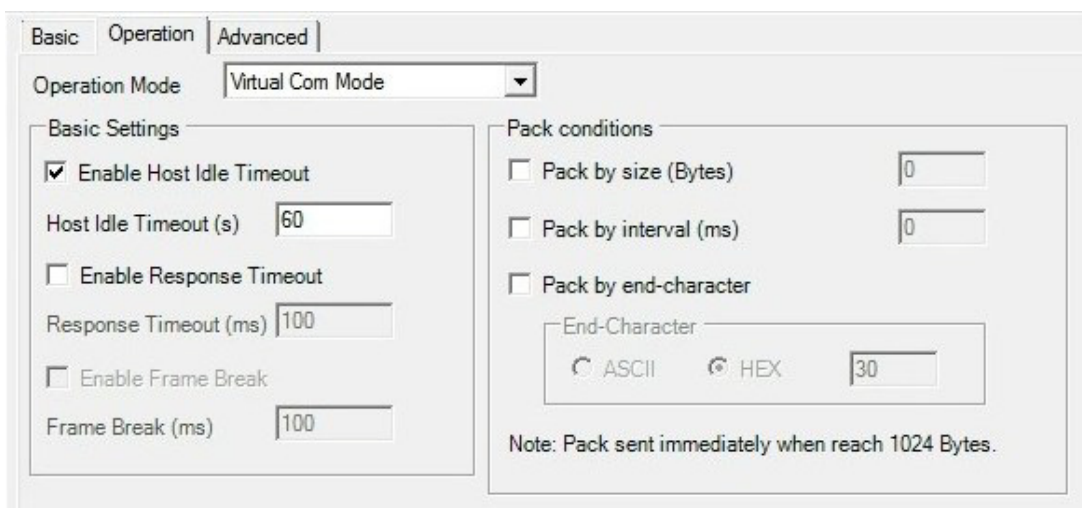

Host Idle Timeout (10 to 255 seconds):

The “Host Idle Timeout” setting monitors the connection between the host and the device. If the “Host Idle Timeout” setting time is reached, the device server will release the resources allocated to the port mapping. This prevents a stalled host from affecting the connective device.

Note! The default value of “Host Idle Timeout” is 60 seconds.



The device provides Multi-access function through Ethernet connection path. Allow the maximum of 5 connections to open one serial port simultaneously. In the mode, all connection has to use the same serial setting. If one serial setting of these connections is different from others, the data communication may operate incorrectly.

There are two operating mode of Multi-access function. One is Normal mode; another is Round-Robin mode.

Normal mode:

Disabling “Response Timeout” parameter, the device server will operate in “normal mode”. When multiple hosts open the serial port simultaneously, the device server only offers control ability for the first connected host and provides data communication function for others. Each serial port supports up to five simultaneous connections, so multiple hosts can transmit/receive data to/from the same serial port simultaneously. Every host can transmit data to the same serial port, and the device server will also transmit data to every host. When the multiple hosts transmit data to the same serial port at the same time, the received data from Ethernet and the outputs of serial port are mixed. When the device server receives data from serial port, the data will also be transmitted to the connected hosts simultaneously.

Round-Robin mode:

After enabling “Response Timeout” parameter, the device will operate in “Round-Robin mode”. Each serial port supports up to five simultaneous connections, so multiple hosts can transmit/receive data to/from the same serial port simultaneously. Every host can transmit data to the same serial port simultaneously, but the device will process the data communication in order. The device will process the first host’s request and reply the response to the first host. The device server can determine the end of the serial acknowledgement via response timeout. When the device receives nothing from serial port after the setting of response timeout, the device will reply the acknowledgement to the host and then process the next host’s request. While the connected hosts are more and “Response Timeout” is long, the process time is much longer.

Frame Break is a very important parameter for Round-Robin mode. This parameter is the smart way to reduce inefficient waiting time and the device can transmit data more efficiently. Disabling the Frame Break function, the device will wait “Response Timeout” period, whether the device have transmitted the data. During this period, the commands from hosts will be queued and the device just processes this command. Enabling “Frame Break”, if the serial port idle is longer than the “Frame Break” period, the device will assume the communication is completed and continue the next host’s query. This is an efficient way to reduce the waiting time and improve the performance.

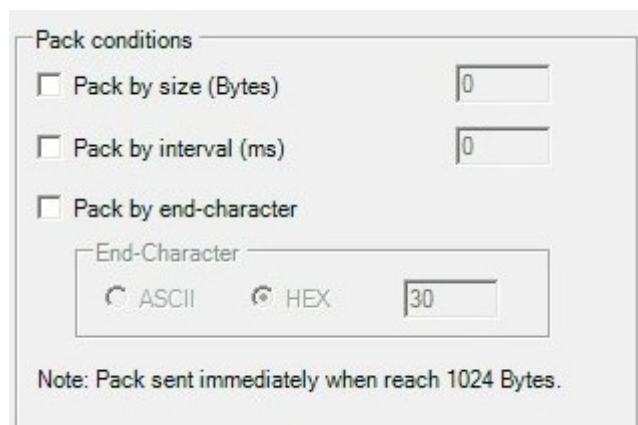

Pack conditions

Pack by size (Bytes)

Pack by interval (ms)

Pack by end-character

End-Character

ASCII HEX

Note: Pack sent immediately when reach 1024 Bytes.

Data Pack

Data pack means you can set condition of receiving data from serial port to be a package according to your application. There are three options to set the data packing: by data size (Byte), by time interval (ms), or by end of character.

3.5.2 Data Mode (USDG Mode)

The device can be Data Server or Data Client either. Both operations support TCP and UDP protocol. The device makes your serial devices behave just like networking devices. You can issue commands or transmit data from serial devices, which connected to the device server, to any devices that are connected to the Internet.

The device allows a maximum of 5 host PCs to simultaneously access data via polling networking architecture. You can use it according to your application. If you want to access the device, you must ascertain your application software supports standard networking application programming interface (API) such as: WinSock Socket.

You might select “USDG Mode” as the following figure to change the mode of the port to TCP server/client or UDP mode.

The screenshot shows a configuration window with three tabs: Basic, Operation, and Advanced. The 'Operation Mode' dropdown is set to 'USDG Mode'. Below it, the 'Mode' dropdown is set to 'Data Mode'. The 'Data Mode Configuration' section is expanded, showing a 'Protocol' dropdown set to 'TCP'. Underneath, there are three sub-sections: 'Basic', 'Peers', and 'Data Pack'. The 'Basic' sub-section contains 'Timeout Settings' with three options: 'Enable Time Sharing (ms)' (checked, value 1000), 'Enable Frame Break (ms)' (checked, value 1000), and 'Enable Auto Connect Peer IP' (unchecked). On the left side of the window, there are 'Common Settings' with 'Data Listen Port' (5300) and 'Command Listen Port' (5400), and 'Basic Settings' with 'Enable' checked and 'Data Idle Timeout (s)' (60).

Protocol

The device provides TCP and UDP two protocols. In settings, you can choose either TCP mode or UDP mode according to your application.

Data Listen Port

The TCP/UDP port number represents the source port number, and the number is used to identify the channel for remote initiating connections. Range: 1024-65533. If an unknown caller wants to connect to the system and asks for some services, they need to define the TCP/UDP port to carry a long-term conversation.

Each node on a TCP/IP network has an IP address, and each IP address can allow connections on one or more TCP port. The well-known TCP ports are those that have been defined; for example, port 23 is used for Telnet connections. There are also custom sockets that users and developers define for their specific needs. The default TCP/UDP port of the device is 5300. The example initial 5300 is System Port, and 5301 is Data Port. But users can adjust them by one's preference or application.

Each port has its own data listen port to accept connected request of other network device. So, the data listen port can't be set the same value. You can transmit/receive data to/from device via the data listen port.

Command Listen Port

Each port has its own command listen port to accept connected request of other network device. So, the command listen port can't be set the same value. You can use 'AT command' to change the port setting via the command listen port. The Command Listen Port should be different from the Data Listen port.

Data Idle Timeout

The default is 60 seconds. If you want to keep connection continually, you can disable the Data Idle Timeout. Data idle Time is the time period in which the device waits for data. If the device does not receive data over an established idle time, the device will disconnect temporarily. When the data comes to the device, it will reconnect automatically. Users do not need to reconnect.

Enable Time Sharing

The device provides Multi-access function through Ethernet connection path. Allow the maximum of 5 connections to open one serial port simultaneously. In the mode, all connection has to use the same serial setting. If one serial setting of these connections is different from others, the data communication may operate incorrectly.

There are two operating mode of Multi-access function. One is Normal mode; another is Round-Robin mode.

Normal Mode

Disabling "Response Timeout" parameter, the device will operate in "normal mode". When multiple hosts open the serial port simultaneously, the device only offers control ability for the first connected host and provides data communication function for others.

Each serial port supports up to five simultaneous connections, so multiple hosts can transmit/receive data to/from the same serial port simultaneously. Every host can transmit data to the same serial port, and the device will also transmit data to every hosts. When the multiple hosts transmit data to the same serial port at the same time, the received data from Ethernet and the outputs of serial port are mixed.

When the device receives data from serial port, the data will also be transmitted to the connected hosts simultaneously.

Round-Robin Mode

Enabling "Response Timeout" parameter, the device server will operate in "Round-Robin mode". Each serial port supports up to five simultaneous connections, so multiple hosts can transmit/receive data to/from the same serial port simultaneously. Every host can transmit data to the same serial port simultaneously, but the device will process the data communication in order. The device will process the first host's request and reply the response to the first host. The device can determine the end of the serial acknowledgement via response timeout. When device receives nothing from serial port after the setting of response timeout, the device will reply the acknowledgement to the host and then process the next host's request. While the connected hosts are more and "Response Timeout" is long, the process time is much longer.

Frame Break is a very important parameter for Round Robin mode. This parameter is the smart way to reduce inefficient waiting time and the device can transmit data more efficiently. Disabling the Frame Break function, the device server will wait “Response Timeout” period, whether the device have transmitted the data. During this period, the commands from hosts will be queued and the device just processes this command. Enabling “Frame Break”, if the serial port idle is longer than the “Frame Break” period, the device will assume the communication is completed and continue the next host’s query. This is an efficient way to reduce the waiting time and improve the performance.

The screenshot shows the "Data Mode Configuration" window. At the top, the "Protocol" is set to "TCP". Below this are three tabs: "Basic", "Peers", and "Data Pack". The "Peers" tab is selected. Underneath, there is a section titled "Peers for Receiving Data (0/16)". This section contains three input fields: "Local Port", "Peer IP", and "Peer Port". Below these fields is a table with three columns: "Local Port", "Peer IP", and "Peer Port". To the right of the table are two buttons: "Add" and "Delete".

Local Port	Peer IP	Peer Port
------------	---------	-----------

Peer Number

Set the number of network device which you want to connect. You can set a maximum of sixteen network devices which you want to connect. You need to fill out the IP Address and Port of network devices which you want to connect.

Data Mode Configuration

Protocol **TCP**

Basic | Peers | **Data Pack**

Pack conditions

Pack by size (Bytes)

Pack by interval (ms)

Pack by character timeout (4 Bytes)

Pack by end-character

End-Character

ASCII HEX

Note: Pack sent immediately when reach 1024 Bytes.

Data Pack

Data pack means you can set condition of receiving data from serial port to be a package according to your application. There are four options to set the data packing: by data size (Byte), by time interval (ms), by character timeout (4 Bytes), or by end of character.

3.5.3 Control Mode (USDG Mode)

In Control Mode, the EKI device presents a modem interface to the attached serial device: it accepts AT-style modem commands to connect/disconnect to other networking device. If you want serial device running application program to connect/disconnect to different devices dynamically, you can use controlling mode.

Control mode provides three kinds of modem AT-style commands. The serial devices can use these commands to control the EKI device to connect/disconnect to remote networking device. Thus, intelligent serial devices such as standalone PLC will send/receive data to/from devices one by one via Ethernet.

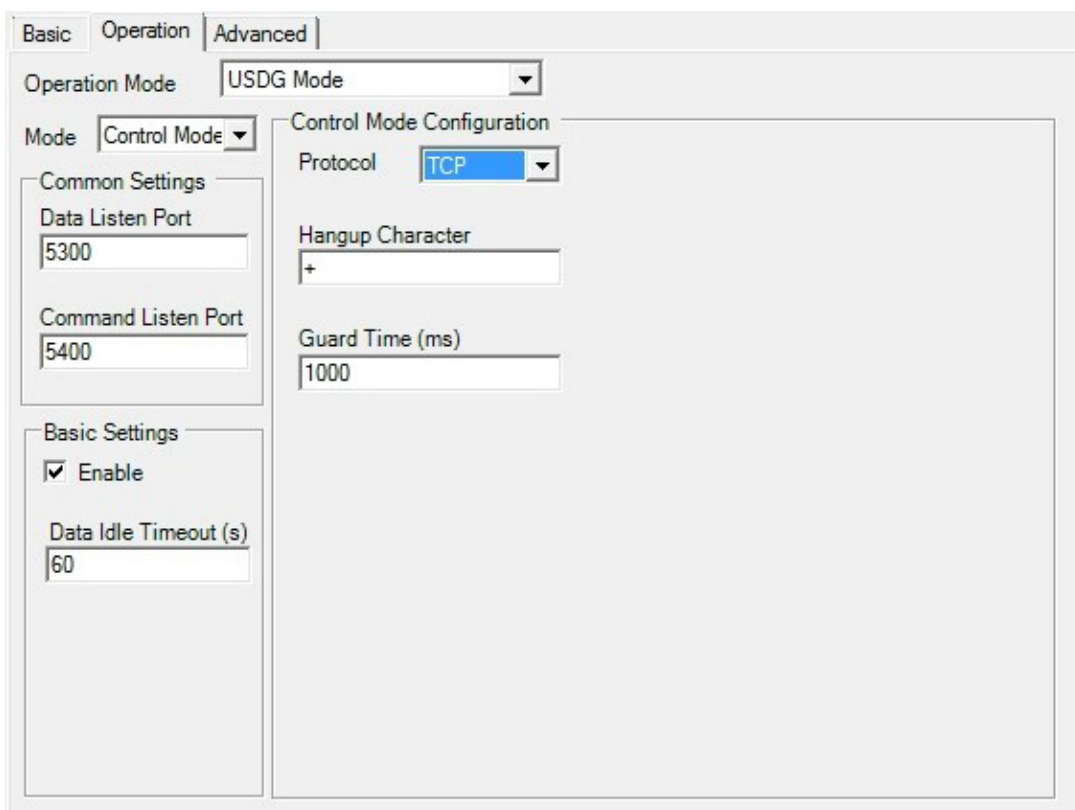

The screenshot displays the configuration interface for the EKI device in Control Mode (USDG Mode). The interface is divided into several sections:

- Operation Mode:** Set to USDG Mode.
- Mode:** Set to Control Mode.
- Common Settings:**
 - Data Listen Port: 5300
 - Command Listen Port: 5400
- Basic Settings:**
 - Enable:
 - Data Idle Timeout (s): 60
- Control Mode Configuration:**
 - Protocol: TCP
 - Hangup Character: +
 - Guard Time (ms): 1000

Refer to the USDG Data Mode to setup the Data Listen Port, Command Listen Port, and Data Idle Timeout.

Hang-up Character

The default character is “+”. After you have connected to another serial device via EKI device, you may need to disconnect. Then you can use the command “+++” to disconnect. To do this leaves your keyboard idle (don't press any keys) for at least several seconds, then press “+” three times. You can set “Guard Time” to define the idle time. Be sure that you have to press “+” over the idle time.

Guard Time

The default value is 1000 ms.

Example: <Guard Time>+++<Guard Time>

Control Mode is designed for use with legacy operating systems, such as MS-DOS, that do not support TCP/IP Ethernet. By connecting one of EKI's serial ports to the MS-DOS computer's serial port, it is possible to use legacy software originally designed to transmit data via modem, but now transmit the data over the Ethernet.

Dial-in (Use TCP connect to serial port of EKI)

EKI listens for a TCP/IP connection request from the remote host. When a TCP connection is coming, there will have prompt string "RING" shows on serial port site. After the system prompting the "RING" string, user can use "ATA" command to accept the connection or just ignore it. After accepted the connection, EKI will enter data mode.

Dial-out (From serial port connect to specific TCP host target)

User can use the AT Command "ATD <IP>#<TCP port>" to connect to a specific TCP target host from serial port. When the TCP connection is accepted by the remote host, EKI will show "CONNECT" string to serial port and enter data mode.

3.5.4 Control Mode Command List

EKI supports the following commands:

AT command	Description
ATA	Answer
ATD	Dial up the IP address#Port No.
ATE	ATE0=Echo OFF ATE1=Echo ON (default)
ATH	On-hook
ATZ	Reset and Recall user's settings
AT&F	Restore factory's Default settings

3.6 Advanced Settings

The serial device server provides the advanced settings for some special applications which need critical time requirements. In normal applications, these settings are recommended not to be set to avoid the unusual action happened.

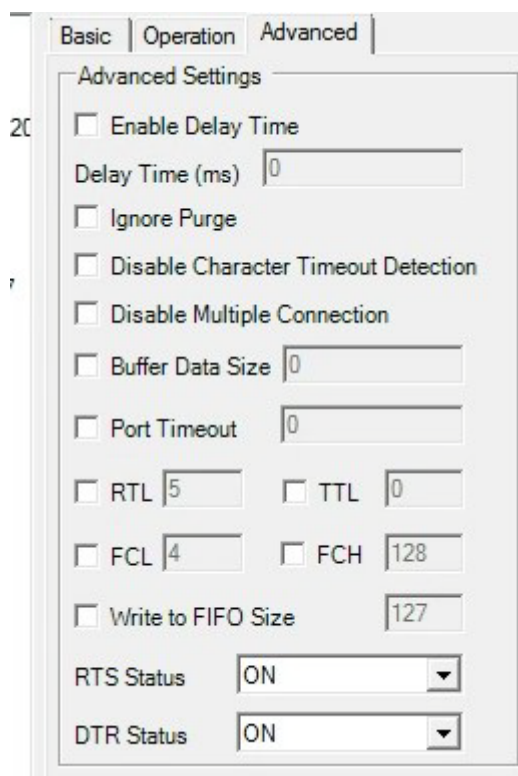

Enable Delay Time (ms)

When you enable the delay time, the serial port will postpone the received data for the time interval you set, and then send the received data to the TCP/IP network.

Ignore Purge

Some application program will purge the serial port while it is the first time opens this serial port. You can ignore the purge command by enable this option.

Disable Character Timeout Detection

Enable this option will disable the serial port character timeout detection.

Disable Multiple Connection

Enable this option will disable the multi-access function, thus the only one TCP connection is allowed on this serial port.

Buffer Data Size

It determines the internal buffer size to queue data to become a packet.

Port Timeout

It determines the time period that received data from serial port will be postponed.

RTL (Receiver Trigger Level)

It determines how often or when the receiver interrupt will be triggered.

TTL (Transmitter Trigger Level)

It determines how often or when the transmitter will be triggered.

FCL (Flow Control Lower Trigger Level)

FCH (Flow Control Higher Trigger Level)

It determines when the transmission will be suspend or resume.

Write to FIFO size

It determines the maximum characters will be written into one interrupt.

RTS/DTR Control

You can configure what happen to the RTS and DTR signals when the cellular and Ethernet connection goes down.

Note! *These settings are just for some special application cases. We strongly recommend do not enable the advanced settings in normal usage.*



3.7 Security Configuration

3.7.1 Accessible Function

Summary | System | Accessible | System Ever

Function Accessible Setting

Allow any IP to access

Specified IP which can access

Accessible IP Address (0/32)

	Add
	Delete

Allow any IP to access:

The default option, any host PC can communicate with this serial device server.

Specified IP which can access:

Type the IP address in the column and click “Add” or “Delete” button to make the accessible IP address list. The limit of this list is 32 IP addresses.

3.8 Port Monitor

Configuration utility provides an excellent function that allows monitoring the serial ports' status. It will present each serial port's operation mode and status. The IP address of Host PC which is communicating with serial port will be list on the right window. Click "Refresh" button, the status will be refresh once. It will be auto refresh after click "Auto Refresh" and the time duration is depending on the setting (the default value is 1000ms).

The screenshot shows the 'Monitor' tab of a configuration utility. At the top, there are several tabs: Summary, System, Accessible, System Event, PortEvent, Mail Alert, SNMP Trap, and Monitor. Below the tabs, there are two buttons: 'Refresh' and 'Auto Refresh'. To the right of these buttons is a text input field containing '1000' followed by 'ms'. Below this is a table with the following data:

Port	Mode	Status	Tx Count	Rx Count	Total Tx	Total Rx
Port 1	Virtual Com Mode	Idle	0	0	0	0
Port 2	Virtual Com Mode	Idle	0	0	0	0

At the bottom left, there is a 'Latest Update Time' label with a value of '01:41:42'. On the right side, there is a section titled 'Port 1 has 0 Peers' with a checked checkbox labeled 'Sort host IP addresses' and an empty list box below it.

3.9 Administrator Settings

The configuration utility provides several administrator settings for easy management and configuration. Right click the mouse on the device name in the sub-tree of Serial Device Sever List Area, and select these administrator settings.

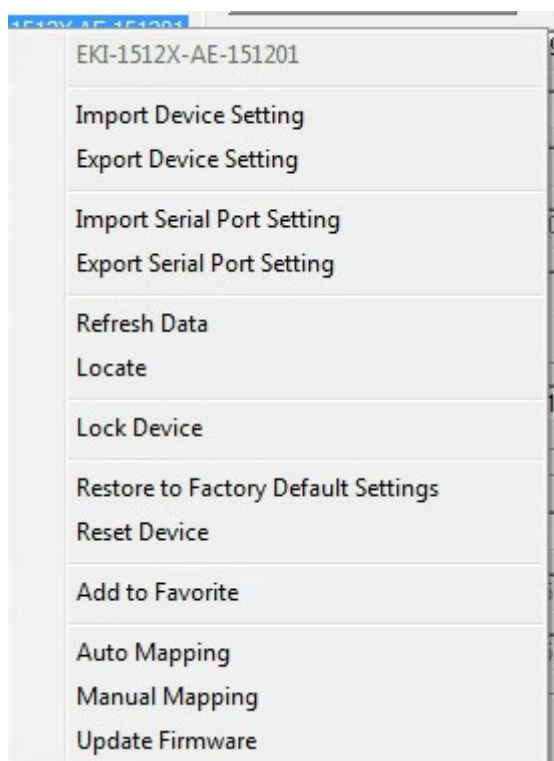

3.9.1 Import/Export Device Setting

The utility allows importing or exporting the serial device server's setting via the ".conf" file format.

3.9.2 Import/Export Serial Port Setting

The utility allows importing or exporting the serial port setting including "Basic Setting" and "Operation Setting" via ".sps" file format.

3.9.3 Locate the Serial Device Server

If there are many serial device servers need your management, you may need to identify which unit is correct to configuration on utility. Click "Locate" to make that unit's "Status" LED be steady on until you click "Stop Locate".

3.9.4 Lock the Serial Device Server (Password Protection)

The configuration utility provides the “Lock Device” function to make it more confidential. You need to set up a password while the first time clicking “Lock Device”. Be sure to click “Reset Device” to restart the serial device server and store your setting password into the memory.

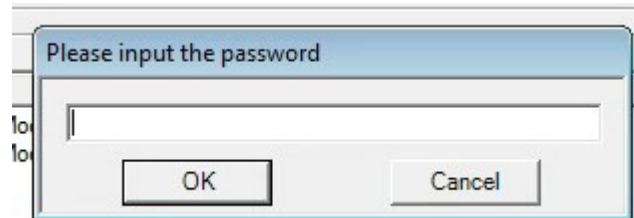

Click “Unlock Device” to unlock the serial device sever, and you need to fill in the password you have set up before. If you forgot the password, the only way to solve this problem is to restore the setting of the serial device server to the factory default which will be introduced next section.

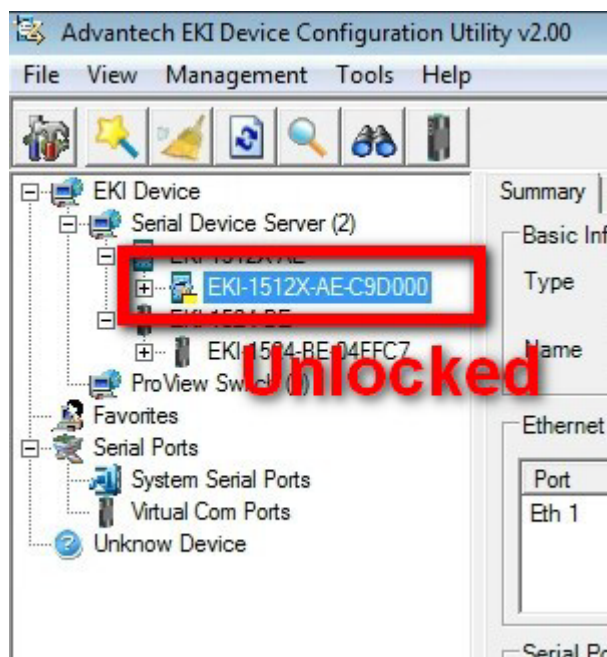

If you want to disable this function or change the password, click “Change Password” to change the password to default “None” (leave the new password and confirm new password columns blank) to disable this function or other password you want to change. Be sure to click “Reset Device” to restart the serial device sever and store the new password into the memory.

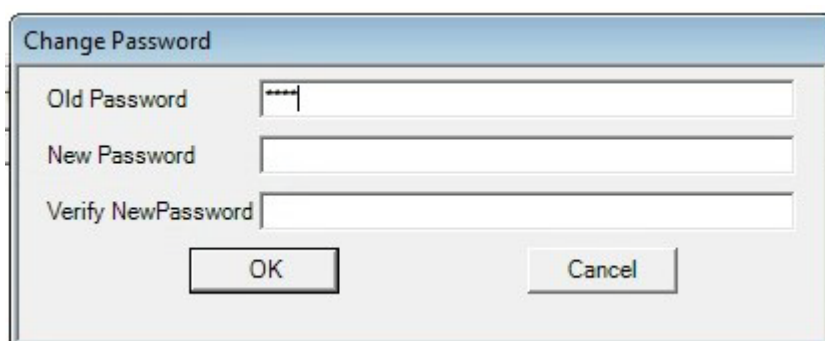

3.9.5 Restore to Factory Default Setting

The configuration utility provides this function to let you can restore the serial device server to factory default settings. The confirm message will be pop-up while clicking “Restore to Factory Default Settings”. If you really want to restore the serial device server to factory default settings, please click the “Yes” button to continue.

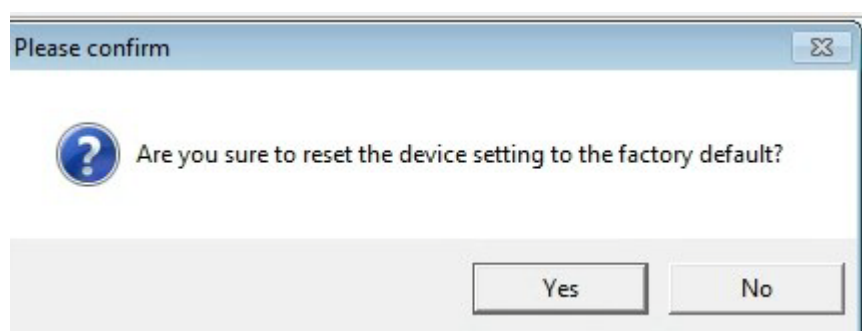

Then, power off the serial device server within 10 seconds, after reconnecting the power back, the all setting will be reset to the factory default. If the power remains more than 10 seconds, the serial device server will not have any changes.

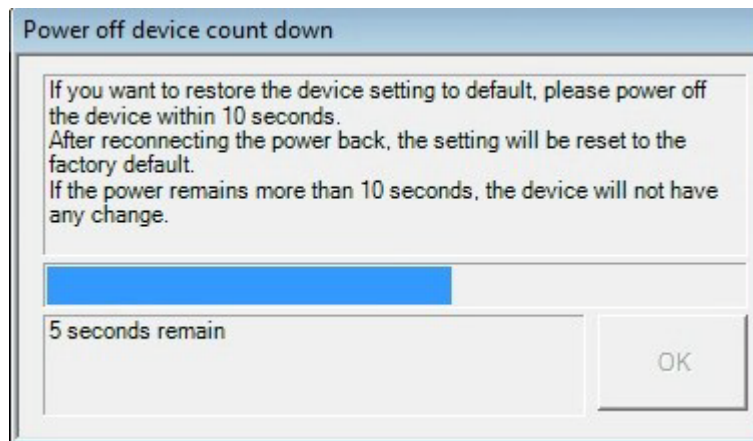

3.9.6 Update firmware

Advantech continually upgrades its firmware to keep up with the ever-expanding world of computing. You can use the update firmware function in the utility to carry out the upgrade procedure. Please access Advantech's website: <http://www.advantech.com> to download the latest version of the firmware. Before update the firmware, make sure that your host's Network domain is as same as the serial device server or the host can establish the TCP connection to the serial device server.

Right Click on the device name and select "Update Firmware" function.

Select the firmware file you want to update.

Wait for few seconds to process the updating firmware. After downloading the firmware completely, click on the "OK" button. The serial device server will restart automatically.

Note! *Be sure that the host PC Ethernet network domain is as same as the EKI-1510X series serial device server or the host PC can establish the TCP connection with the serial device server while doing the updating firmware process.*



Chapter 4

Setting COM
Redirector

4.1 Setting COM Redirector (Virtual COM port)

Advantech COM port mapping software is a serial COM port redirector that creates virtual COM ports and provides access to serial devices connected to Advantech serial device servers. Your serial device applications can communicate with serial devices connected to Advantech serial device servers without software changes.

Since the virtual COM ports work like standard Windows COM ports, your application software sees no difference between a local serial device and one connected to a Advantech serial device server.

The COM redirector utility and Virtual COM port Management utility are integrated into one utility with same GUI. Advantech Serial Device Server Configuration Utility can create all Virtual COM ports using “Auto Mapping” function. You can map the Virtual COM port by yourself.

4.1.1 Auto Mapping

Right click the serial device name on the sub-tree of Device Server List area and select the “Auto Mapping” function.

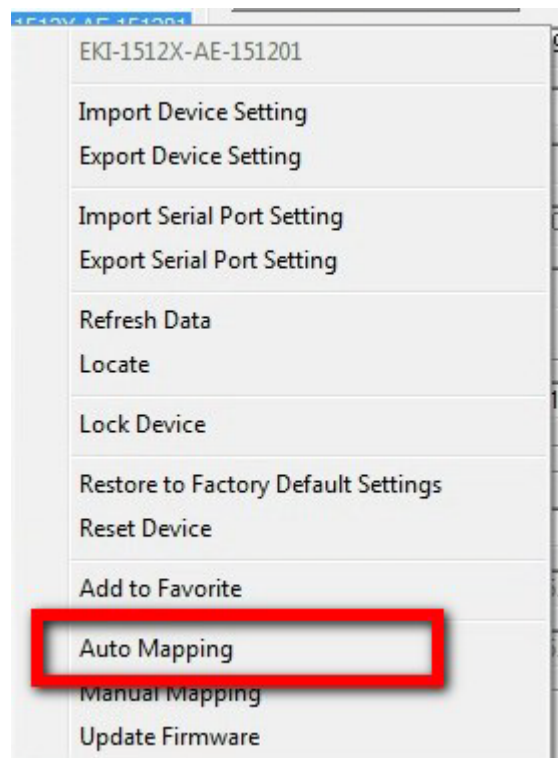

The serial ports that can be assigned to virtual COM will be shown in this window. Select the serial ports you wish to map or click the “Select All” button and press “Map Selected Ports” button. The selected serial ports will be mapped to virtual COM ports in sequential order.

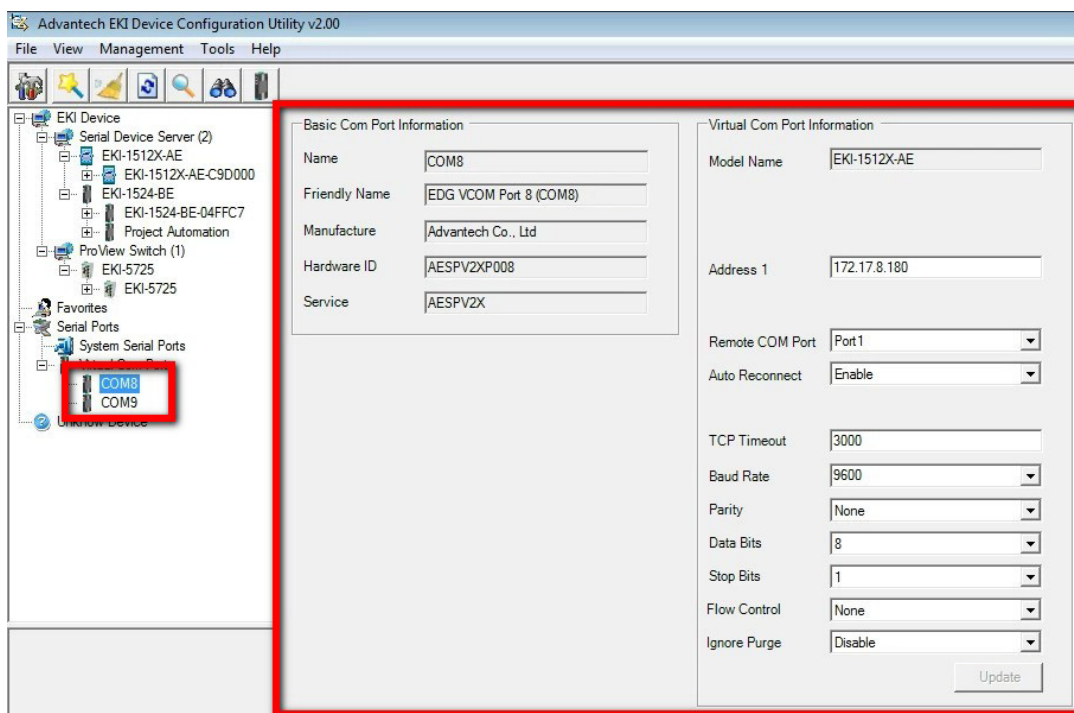
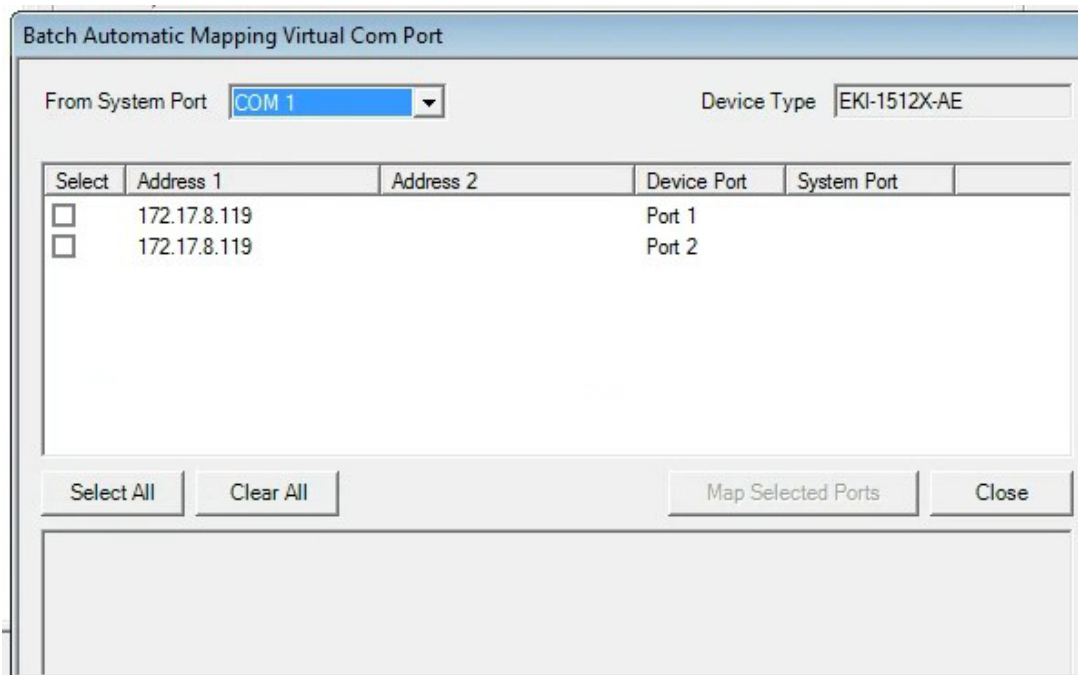

4.1.2 Manual Mapping

Right click the serial device name on the sub-tree of Device Server List area and select the “Manual Mapping” function.

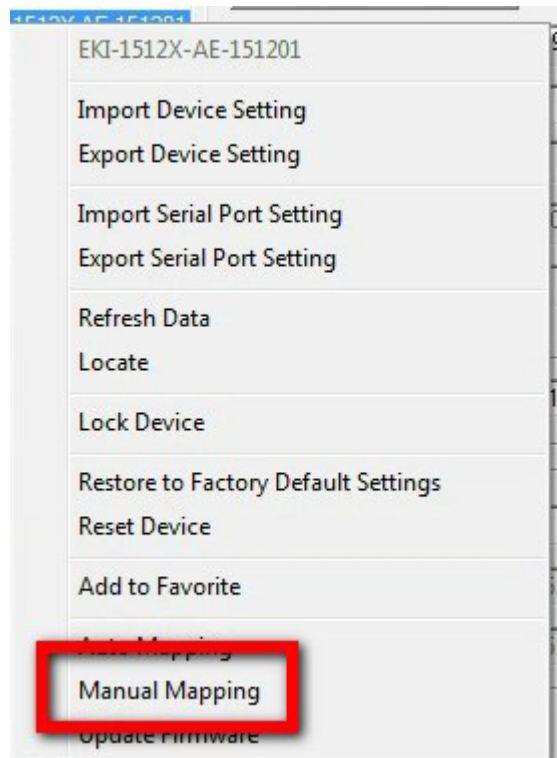

ADAM series, EDG series, and EKI wireless series have only one IP address. Select the serial port on the device server and the host COM that you want to set. Press “Map” to establish the virtual COM port on the host.

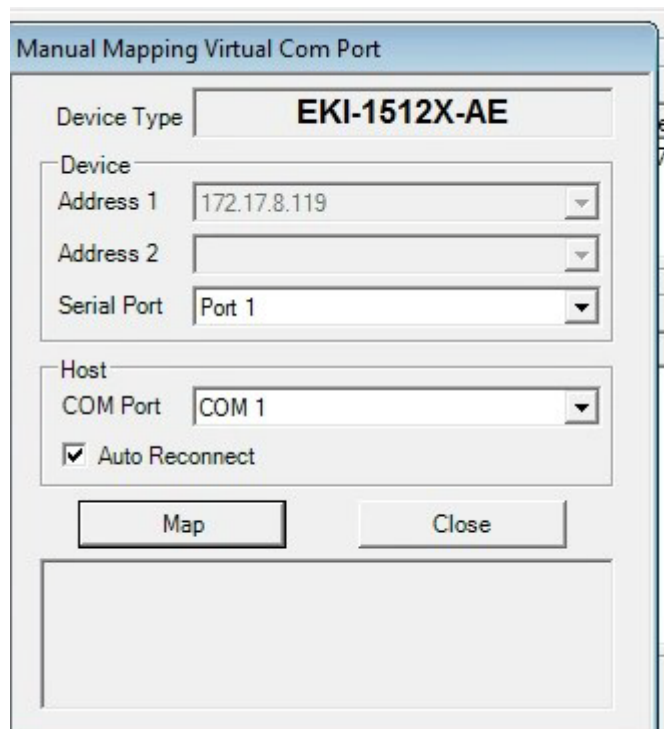

Auto Reconnect Property

Sometimes, the connection between Advantech serial device server and HOST is interrupted by network traffic or powered-off by accident. In such a situation, the host has to reconnect to Advantech serial device server. The function "Auto Reconnect" is for this purpose, if the Advantech serial server loses the connection to its host, the COM redirector will try to re-establish the connection while the host's AP access the virtual COM port. The COM redirector DOES NOT re-establish the connection automatically. When the connection is working again, the host's commands will be automatically received by the Advantech serial device server again. Reconfiguration is not necessary, so this function enhances the reliability of the system.

If the function is disabled, the connection cannot be re-established again unless the COM redirector or host is restarted.

The EKI-1510 series has one Ethernet port. You can select one Ethernet port to establish two Ethernet connections with one virtual COM port. It means that COM redirector will use one connection with the COM port on device server to communicate. If this connection failed, COM redirector will establish another Ethernet connection to communicate with device. The switch time will be 3 seconds ~ 5 seconds depending on the network traffic and host status.

4.1.3 Manual Direct Mapping Virtual COM Port

Click the  button on the Quick Toolbar, you can add a target by selecting the Device Type and inputting the IP address without physically connecting the serial device server to the network.

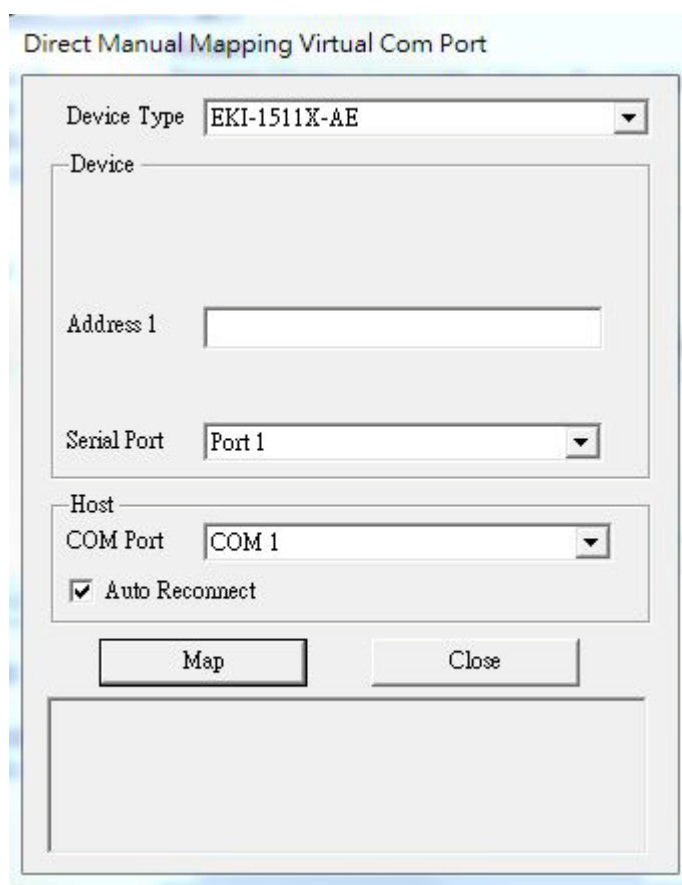

Direct Manual Mapping Virtual Com Port

Device Type: EKI-1511X-AE

Device

Address 1: [Empty text box]

Serial Port: Port 1

Host

COM Port: COM 1

Auto Reconnect

Map Close

4.1.4 Remove the Virtual COM Port

If you want to remove the virtual COM port, you can remove them one by one or group remove ports.

- **Individually Remove**

Right click on COM port you have mapped and select “Remove This Port”.

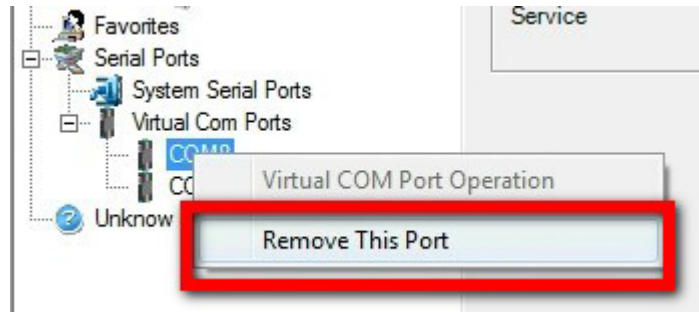

- **Group Remove Port**

Right click on Virtual Com Ports on Device Server List Area and select “Group Remove Port”, you can choose which ports you want to remove.

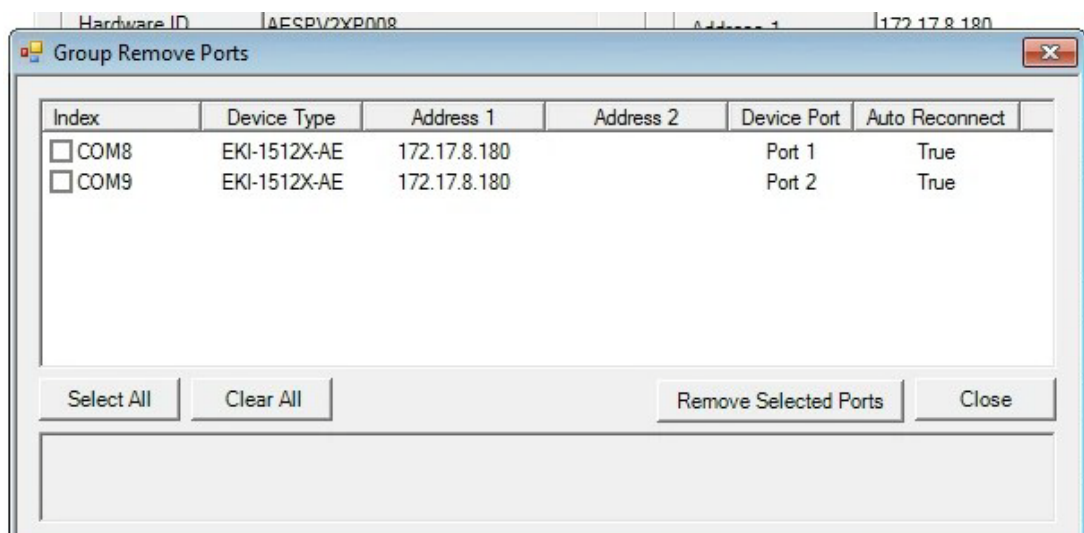
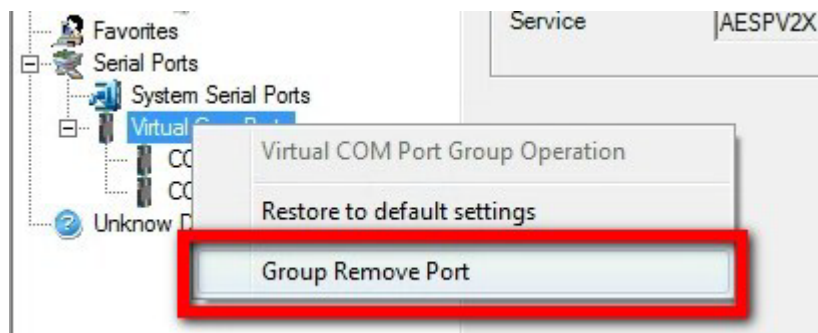

Chapter 5

Web-Based
Configuration

5.1 Overview

The EKI-1510X series serial device server can be configured through a web interface. By using a standard web browser, the same procedure as with the Windows configuration utility can be used. In the browser's address field, enter the IP Address of your EKI-1510X series serial device server. The default IP setting is 10.0.0.1, but you should use the IP which you have previously assigned for this device. Once the IP is entered, you will be presented with the following windows.

Note! *Before using the web-based configuration, make sure your host PC Ethernet network IP domain is as same as the serial device server, or it can establish the TCP connection with the serial device server.*



Note! *All new configurations will take effect after rebooting. The reboot function is located on the main menu of the Web Configuration.*



5.2 Accessing the Web Page

By Configuration utility

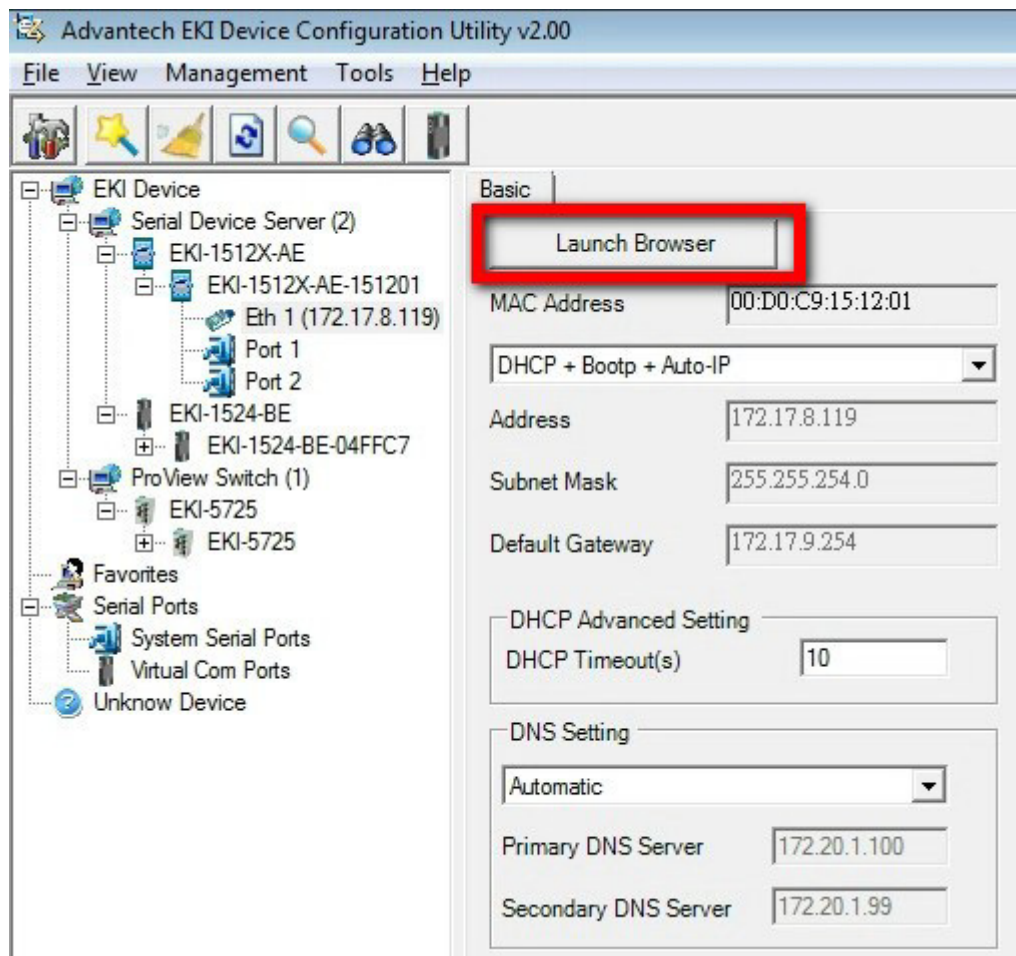

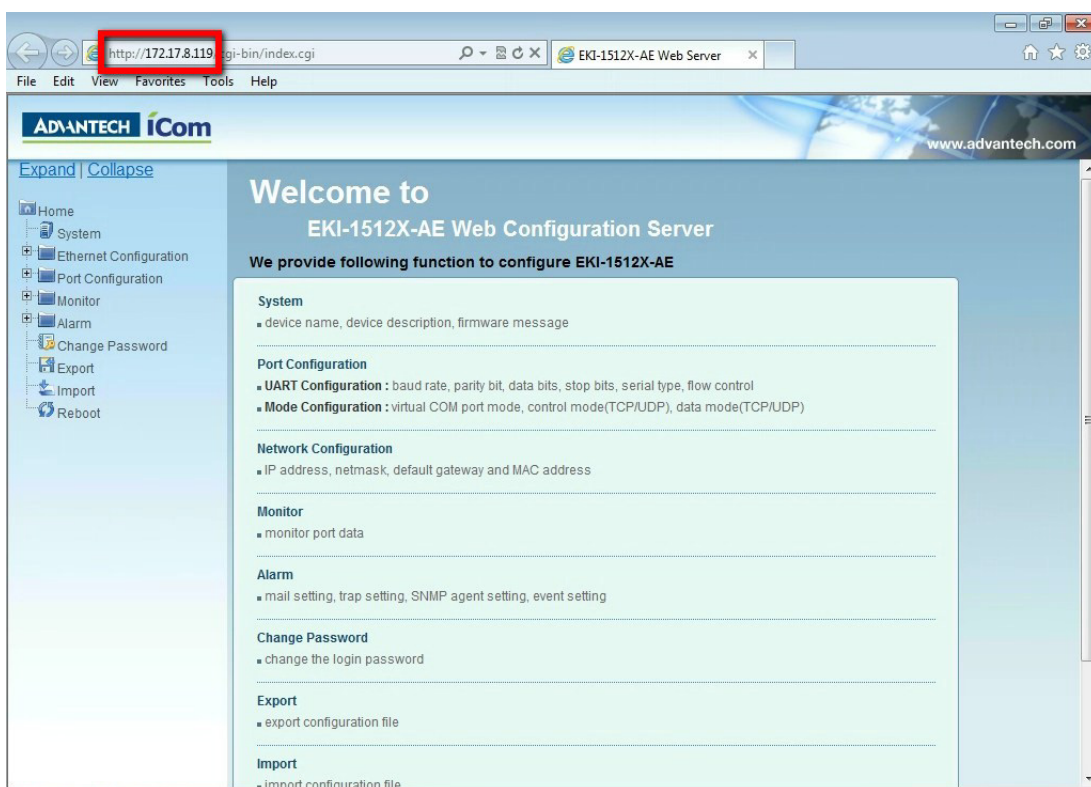

5.3 System

You can change the Device Name and Device Description on this page. You can also enable or disable the Web, Telnet, and SNMP functions. You can also set the Time zone related setting.

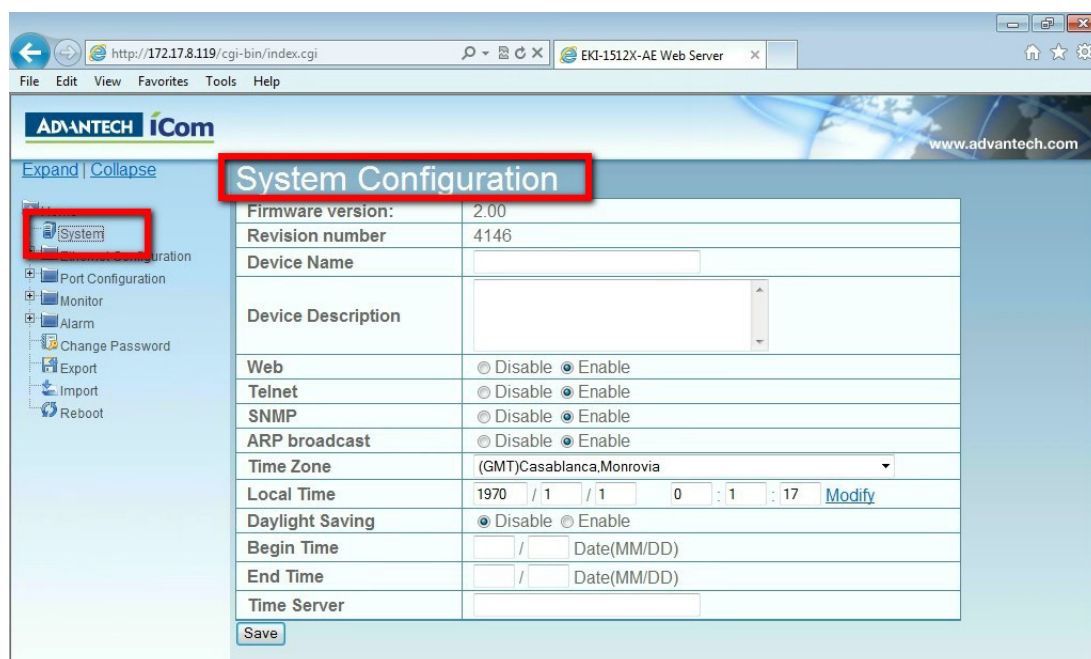

5.4 Network Configuration

Click the Net Configuration, there are Net Mode, IP Address, Subnet Mask, Default Gateway and DNS. Enter the corresponding values for your network environment. Remember press “Save” after fill in all values.

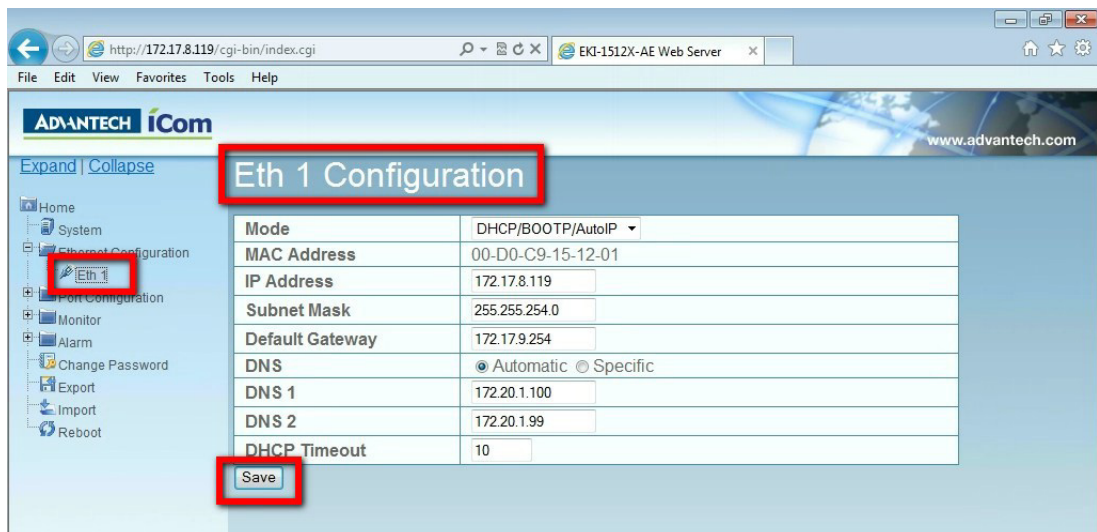

5.5 Port Configuration

There are Basic, Operation Mode, and Advanced Setting in the serial port configuration.

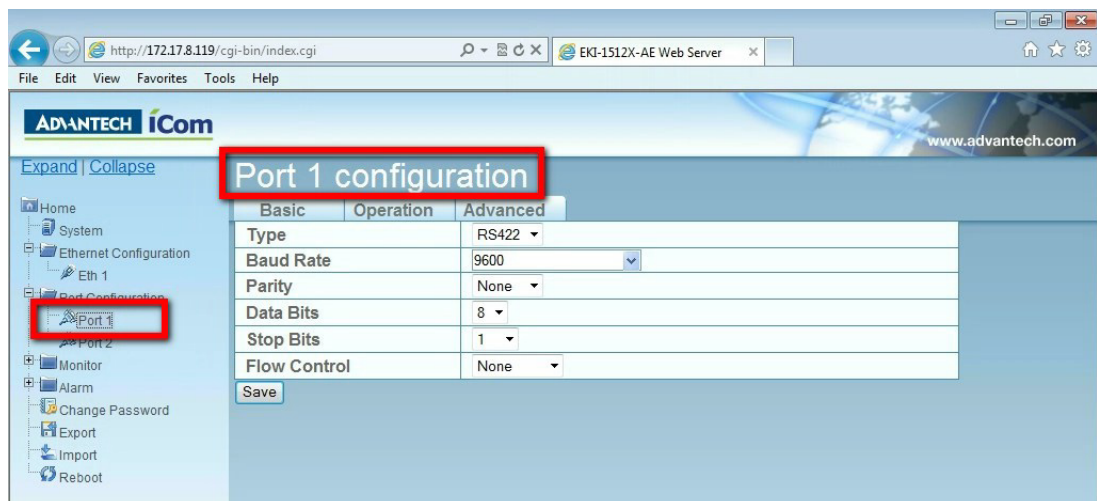

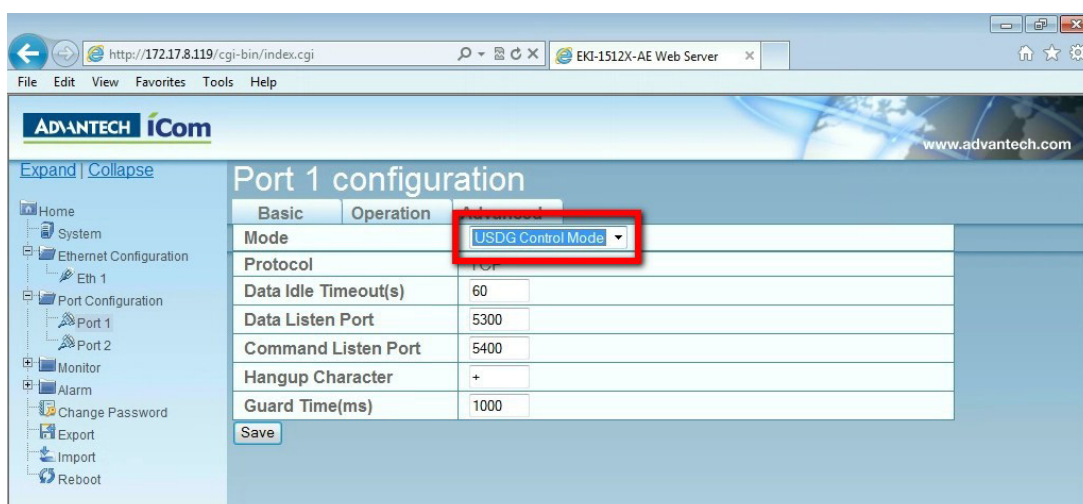
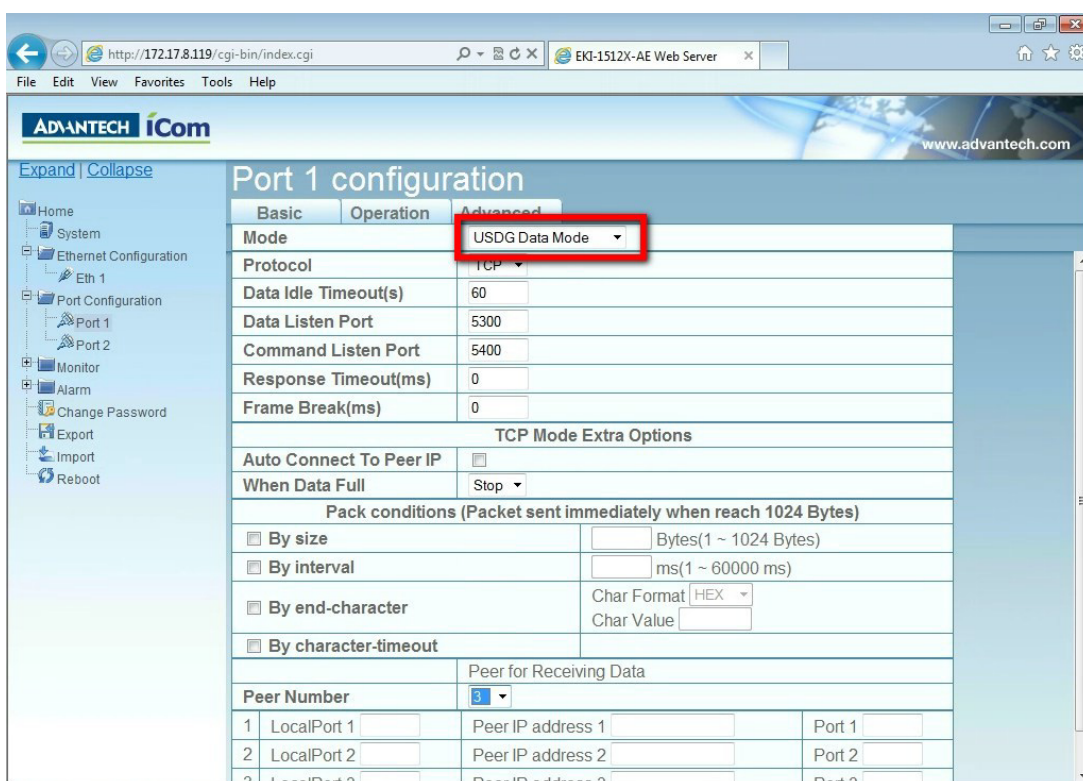
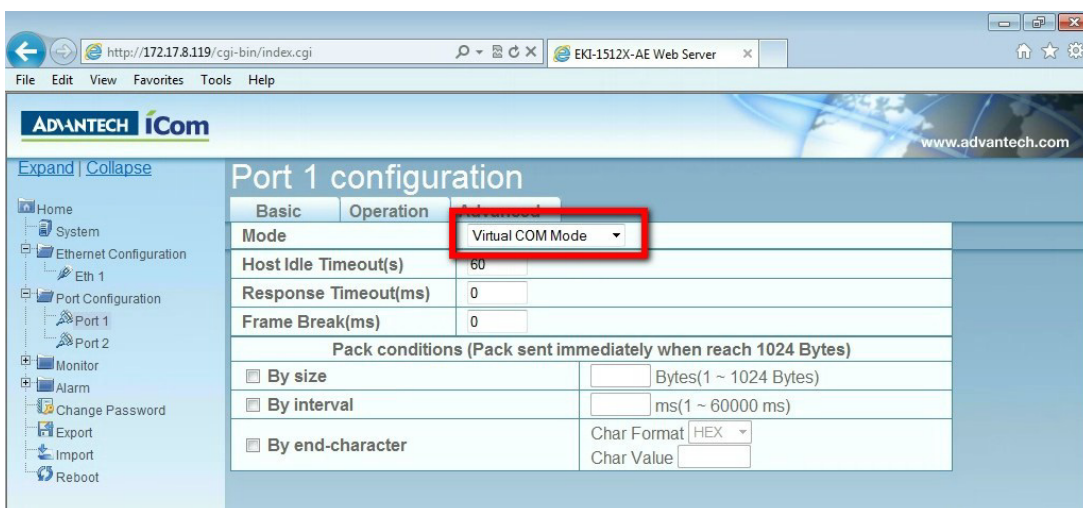

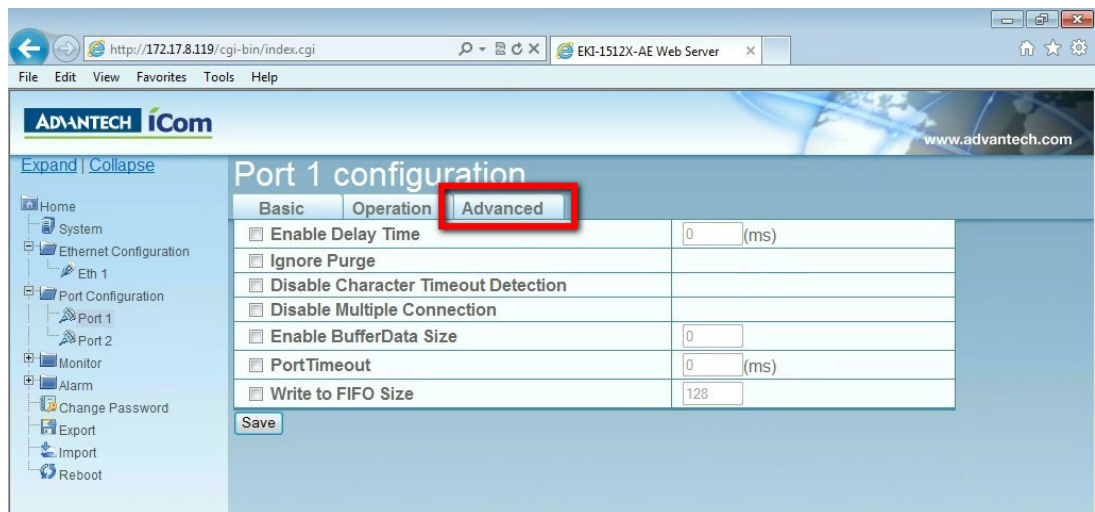
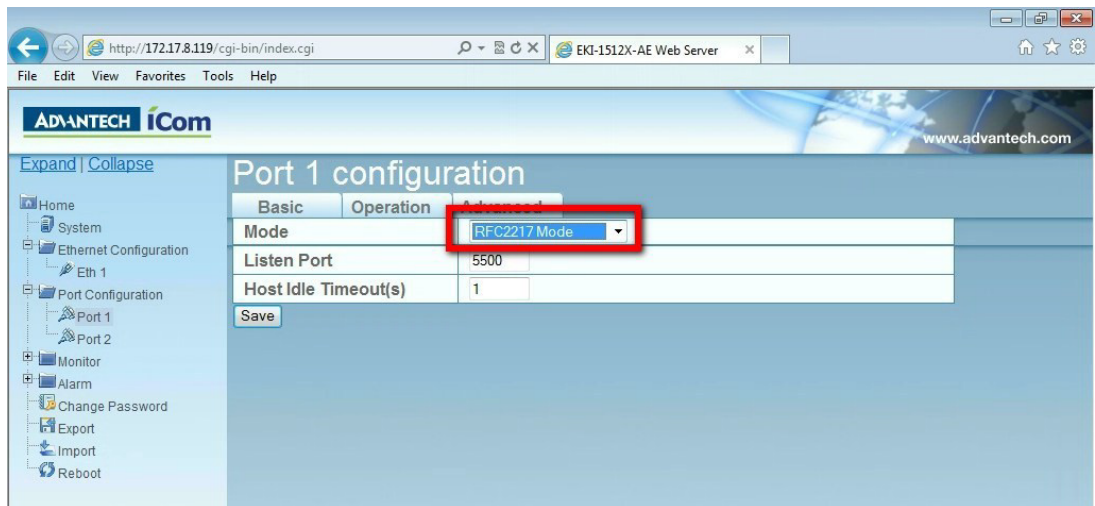

5.6 Monitor

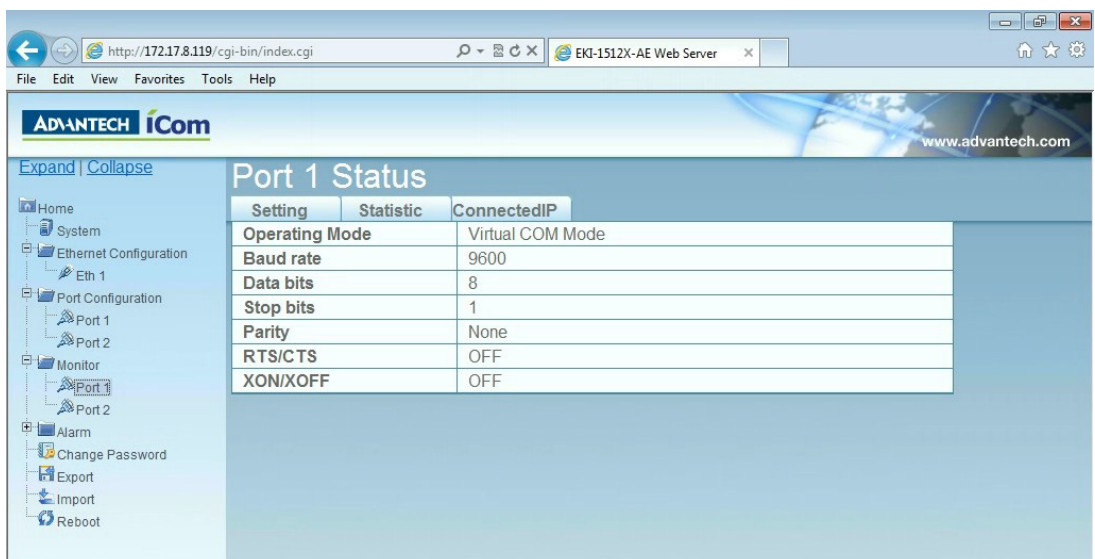

ADVANTECH iCom

Expand | Collapse

Home

- System
- Ethernet Configuration
 - Eth 1
- Port Configuration
 - Port 1
 - Port 2
- Monitor
 - Port 1
 - Port 2
- Alarm
- Change Password
- Export
- Import
- Reboot

Port 1 Status

Setting	Statistic	ConnectedIP
Tx Count	0	
Rx Count	0	
Total Tx Count	0	
Total Rx Count	0	
RTS	ON	
CTS	ON	
DTR	ON	
DSR	ON	
DCD	OFF	

ADVANTECH iCom

Expand | Collapse

Home

- System
- Ethernet Configuration
 - Eth 1
- Port Configuration
 - Port 1
 - Port 2
- Monitor
 - Port 1
 - Port 2
- Alarm
- Change Password
- Export
- Import
- Reboot

Port 1 Status

Setting	Statistic	ConnectedIP	IP Address
Connected IP			
IP 1			N/A
IP 2			N/A
IP 3			N/A
IP 4			N/A
IP 5			N/A
IP 6			N/A
IP 7			N/A
IP 8			N/A
IP 9			N/A
IP 10			N/A
IP 11			N/A
IP 12			N/A
IP 13			N/A
IP 14			N/A
IP 15			N/A
IP 16			N/A

5.7 Auto Warning (Alarm)

You can set the e-mail server and SNMP Trap server in the Setting page, and set the event type in the Event page.

The screenshot shows the 'Alarm Setting' page. The left sidebar contains a navigation tree with 'Setting' selected under the 'Alarm' category. The main content area is titled 'Alarm Setting' and contains the following sections:

Mail Server	
Mail Server	<input type="text"/>
From Email address	admin@advantech.com
Email address 1	<input type="text"/>
Email address 2	<input type="text"/>
Email address 3	<input type="text"/>
Email address 4	<input type="text"/>
SNMP Trap Server	
Trap Server	<input type="text"/>
Trap Version	<input checked="" type="radio"/> v1 <input type="radio"/> v2c
Trap Community	public
SNMP Agent Setting	
Read Community	<input type="text"/>
Write Community	<input type="text"/>
Contact	<input type="text"/>
Location	<input type="text"/>
<input type="button" value="Save"/>	

The screenshot shows the 'Event Type' page. The left sidebar contains a navigation tree with 'Event' selected under the 'Alarm' category. The main content area is titled 'Event Type' and contains the following sections:

System Event		
Cold Start	<input type="checkbox"/> Mail	<input type="checkbox"/> Trap
Warm Start	<input type="checkbox"/> Mail	<input type="checkbox"/> Trap
Authentication failure	<input type="checkbox"/> Mail	<input type="checkbox"/> Trap
IP address changed	<input type="checkbox"/> Mail	
Password changed	<input type="checkbox"/> Mail	
Ethernet1 link down	<input type="checkbox"/> Mail	<input type="checkbox"/> Trap
Ethernet2 link down	<input type="checkbox"/> Mail	<input type="checkbox"/> Trap
DCD changed		
Port 1	<input type="checkbox"/> Mail	<input type="checkbox"/> Trap
Port 2	<input type="checkbox"/> Mail	<input type="checkbox"/> Trap
DSR changed		
Port 1	<input type="checkbox"/> Mail	<input type="checkbox"/> Trap
Port 2	<input type="checkbox"/> Mail	<input type="checkbox"/> Trap
<input type="button" value="Save"/>		

5.8 Change Password

You can change the serial device server password on here:

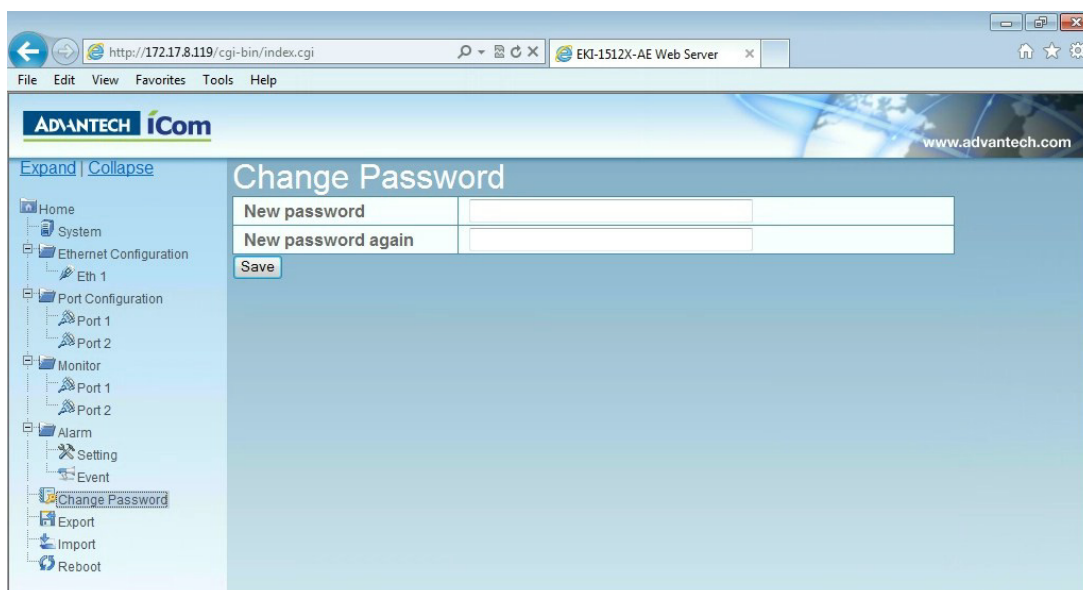

If you want to disable the password protection, just change the password to the default “None” (leave the new password column blank), Be sure to press the “Save” button and reboot the serial device server to make the change effective.

5.9 Import/Export Device Settings

You can Import or Export the serial device server all setting as the “.conf” file format.

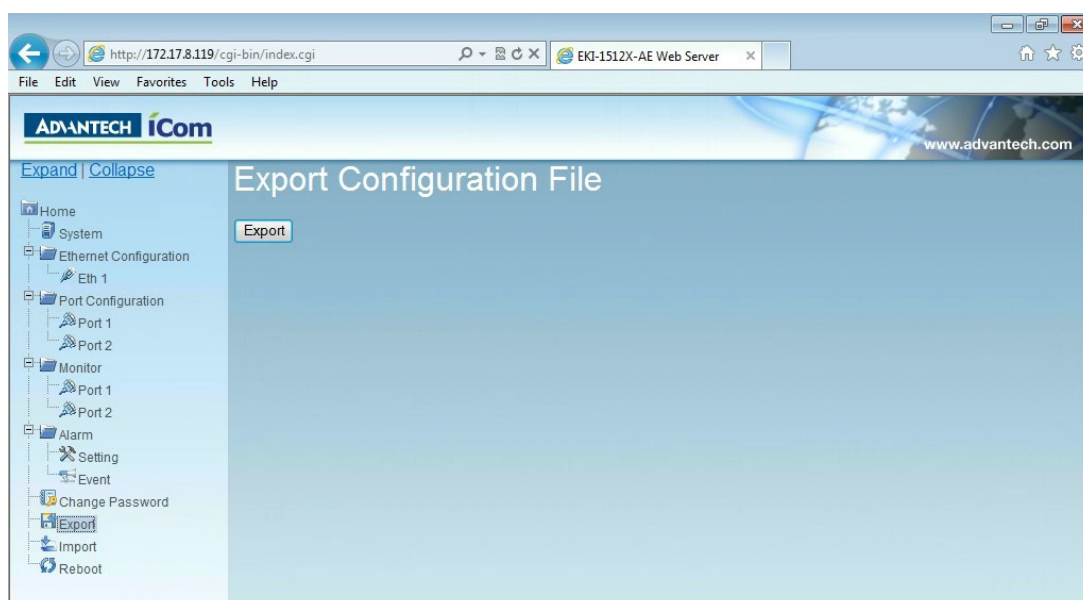

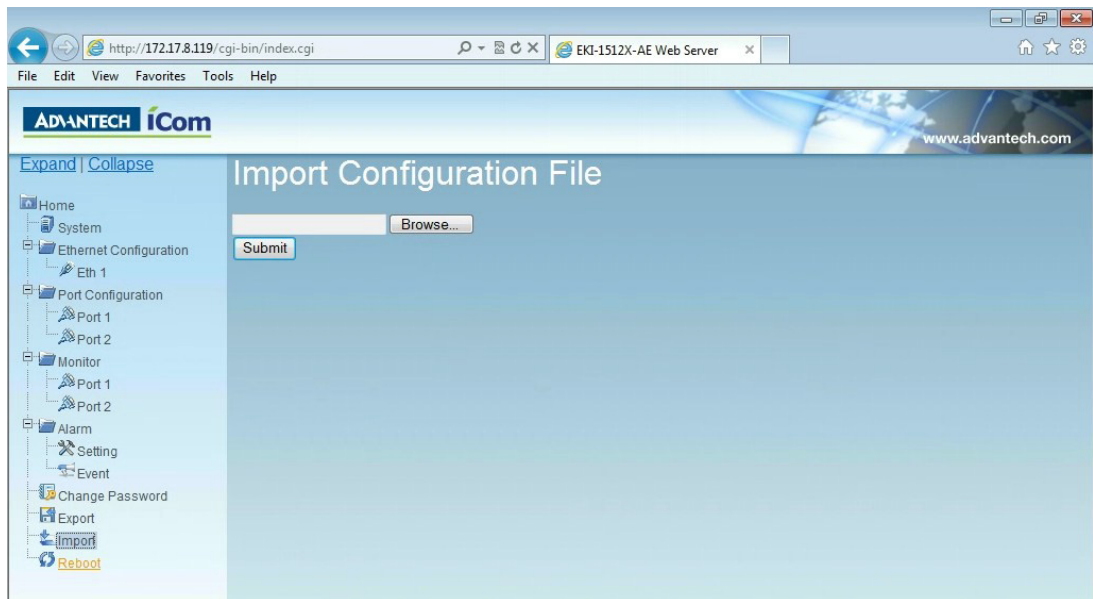

5.10 Reboot

The configuration will take effect after clicking “Save” button. But all configurations will save to flash memory after this reboot step. Press the “Reboot” button and the system will give a reset response. It will take a few seconds to reconnect with the new values.

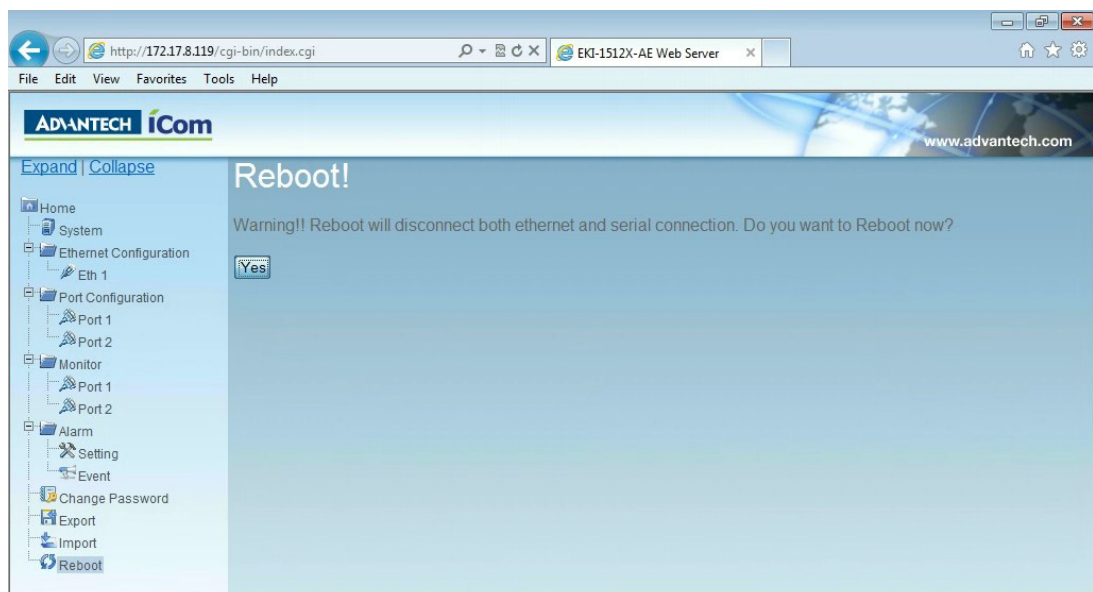

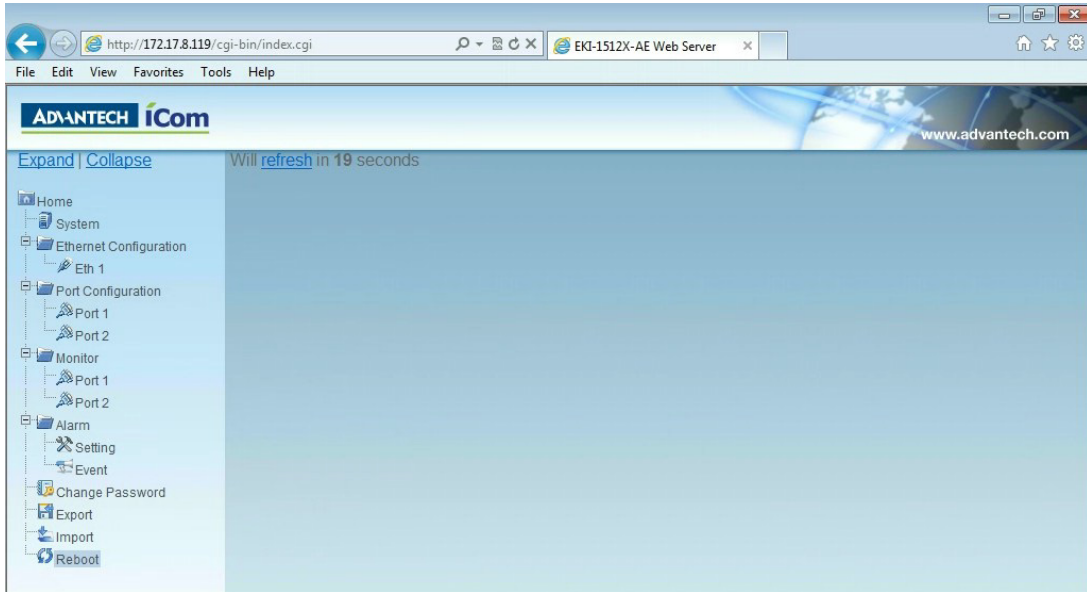

Chapter 6

Telnet Configuration

6.1 Overview

The purpose of the Console Configuration is to help you manage your device in console mode. One of the main functions of the console mode is to change the web configuration login password. You can use terminal software like Hyper Terminal, Telix and other related terminal software.

6.2 Command List

Table 6.1: Console Command List

Command	Function Description
system	Show or configure the system information
port	Show or configure the serial ports information
portadv	Show or configure the serial ports advanced settings
mvcom	Show or configure the serial ports in Virtual COM mode
mctrl	Show or configure the serial ports in Control mode (USDG)
mdata	Show or configure the serial ports in Data mode (USDG)
net	Show or configure the Ethernet ports settings
password	Set or change the password
apply	Write settings to the flash memory and reboot the system immediately
exit	Terminate the shell session
help	Display help information of command list
<tab> <tab>	Display help information of command list
import	Import the serial device server all settings
export	Export the serial device server all settings
monitor	Monitor the serial ports status
alarm	Show or configure the auto warning functions including mail alarm and SNMP alarm
time	Show or configure the time information
service	Enable or disable the web, Telnet and SNMP functions

■ Help

You might type the “help” command or press <Tab> twice to show the supported command list.

[Usage] help

[Function] Display help information of command list

You might use “help” command to show the usage of all commands.

[Usage] help [command]

[Function] Show the usage of command

■ System

Manage the general information about the device.

[Usage] system

[Function] Show firmware version, device name and description

[Usage] system

[Function] Show current device status and information

[Usage] system name XXXX

[Function] Set current device name [XXXX: maximum length 31 bytes]

[Usage] system desc XXXX

[Function] Set current device description [XXXX: maximum length 127 bytes]

■ Port

Port” is the command to show all serial ports information and configure the serial ports settings.

[Usage] port nn or port all

[Function] Show the “nn”th port or all ports information

[Usage] port nn desc XXXX

[Function] Set the “nn”th port’s description [XXXX: maximum length 127 bytes]

[Usage] port nn|all type 422|485 flow 0|1|2|3

[Function] Set serial ports’ type and flow control

Flow 0: None

Flow 1: XOn/XOff

Flow2: RTS/CTS

Flow3: DTR/DSR

[Usage] port nn|all baud XXXX parity n|e|o|m|s data 5|6|7|8 stop 1|1.5|2

[Function] Set the serial ports’ baud rate, parity, data bits, and stop bits.

Parity n: None

Parity e: Even

Parity o: Odd

Parity m: Mark

Parity s: Space

[Usage] port nn|all mode vcom|ctrl|data

[Function] Set the serial ports as virtual COM mode, control mode, or data mode

■ **mvcom**

Show and setup the VCOM mode

[Usage] mvcom

[Function] Show all serial ports mode and related information

[Usage] mvcom nn|all

[Function] Set the “nn”th or all serial ports as the Virtual COM mode

[Usage] mvcom nn|all idleto XX

[Function] Set the “nn”th or all serial ports host idle timeout (S)

[Usage] mvcom nn|all respto XX framebk XX

[Function] Set the “nn”th or all serial ports response timeout and frame break

■ **mctrl**

Show and setup the Control mode

[Usage] mctrl

[Function] Show all serial ports mode and related information

[Usage] mctrl nn|all

[Function] Set the “nn”th or all serial ports as the Control mode

[Usage] mctrl nn|all idleto XX guardt XX hangchr XX

[Function] Set the “nn”th or all serial ports data idle timeout, guard time and hang character

■ **mdata**

Show and setup the Data mode

[Usage] mdata

[Function] Show all serial ports mode and related information

[Usage] mdata nn|all

[Function] Set the “nn”th or all serial ports as the Data mode

[Usage] mdata nn|all protocol TCP|UDP

[Function] Set the “nn”th or all serial ports’ transmit protocol as TCP or UDP

[Usage] mdata nn|all idleto XX lsport XXXX atport XXXX

[Function] Set the “nn”th or all serial ports data idle timeout, listen port, and AT command port

[Usage] mdata nn|all respto XX framebk XX

[Function] Set the “nn”th or all serial ports response timeout and frame break

[Usage] mdata nn|all peernum 1|2|3|4|5|6|7|8|9|10|11|12|13|14|15|16 peer
XX.XX.XX.XX:ppp

[Function] Set the peer IP address and port for receive data

■ net

Show and setup the Ethernet port configuration

[Usage] net 1|2

[Function] Show the first or second Ethernet port status and information

[Usage] net 1|2 mode static|dhcp|boot|all

[Function] Set the network operating mode

[Usage] net 1|2 ip XX.XX.XX.XX netmask XX.XX.XX.XX gw XX.XX.XX.XX

[Function] Set IP address, subnet mask, and default gateway

[Usage] net 1|2 dns auto|specific

[Usage] net 1|2 dns1 XX.XX.XX.XX

[Usage] net 1|2 dns2 XX.XX.XX.XX

[Function] Set the DNS function

■ password

Manage the password protection status.

[Usage] password new XXXX

[Function] Set new password [XXXX: maximum 31 characters]

[Usage] password old XXXX new XXXX

[Function] Confirm the old password and set a new password

■ apply

Make previous settings take effect.

[Usage] apply

[Function] Save the settings to the flash memory and reboot the system immediately

■ exit

Exit console and terminal the connection.

[Usage] exit

[Function] Terminate the shell session

■ **import/export**

Import or export the device setting.

[Usage] import

[Function] Import the serial device server settings' file

[Usage] export

[Function] Export the serial device server settings' file

■ **monitor**

Show the serial ports settings, statistic, and connected IP address

[Usage] monitor port 1|2|...|16 setting

[Function] Monitor the serial ports settings

[Usage] monitor port 1|2|...|16 statistic

[Function] Monitor the serial ports statistic

[Usage] monitor port 1|2...|16 ip

[Function] Monitor the serial ports connected IP address

■ **alarm**

Show or configure the auto warning function

[Usage] alarm

[Function] Show current alarm information.

[Usage] alarm mail server [null|address] from [null|address] to1 [null|address] to2 [null|address] to3 [null|address] to4 [null|address]

[Function] Set current mail server configuration.

[Usage] alarm trap server [null|address] ver [1|2] community [null|name]

[Function] Set current trap server configuration.

[Usage] alarm event mail [cstart] [wstart] [auth] [ip] [passwd]

[Function] Set mail event configuration.

[Usage] alarm event trap [cstart] [wstart] [auth] [ip] [passwd]

[Function] Set trap event configuration.

■ time

Show or configure the time information

[Usage] time

[Function] Show the current time information

[Usage] time YYYYMMDDhhmmss

[Function] Modify the current time information

[Usage] time timezone -12|...|0|1|...|12

[Function] Set the current timezone configuration

[Usage] time daylight on|off begin MMDD end MMDD

[Function] Set the current time daylight saving configuration

[Usage] time ntp XXXX

[Function] Set the NTP timeserver [XXXX: time server]

■ service

Enable or disable some extra service

[Usage] service web enable|disable

[Function] Enable or disable the web-based configuration

[Usage] service telnet enable|disable

[Function] Enable or disable the telnet console

Appendix **A**

List of Known TCP and
UDP Port Numbers

A.1 List of Known TCP and UDP Port Numbers

Port	Protocol	Service
5048	(TCP/UDP)	Configuration Utility
5058	(TCP/UDP)	Configuration Utility
5202	(TCP)	VCOM/RVCOM
9999	(TCP)	Firmware Download
22	(TCP)	SSH
23	(TCP)	Telnet
25	(TCP)	SMTP(Mail Client)
53	(TCP/UDP)	DNS
67	(UDP)	BOOTP Server/DHCP
68	(UDP)	BOOTP Client/DHCP
80	(TCP)	Web Interface/HTTP
123	(TCP)	NTP
161	(UDP)	SNMP
162	(TCP/UDP)	SNMP Trap
443	(TCP)	HTTPS
502	(TCP)	Modbus/TCP(Default)
514	(UDP)	Syslog
546	(TCP/UDP)	DHCPv6 Client
547	(TCP/UDP)	DHCPv6 Server

www.advantech.com

Please verify specifications before quoting. This guide is intended for reference purposes only.

All product specifications are subject to change without notice.

No part of this publication may be reproduced in any form or by any means, electronic, photocopying, recording or otherwise, without prior written permission of the publisher.

All brand and product names are trademarks or registered trademarks of their respective companies.

© Advantech Co., Ltd. 2016