

ATS22C48S6U

soft starter-ATS22-control110V-power
208V(150hp)/460V(350hp)/575V(400hp)

Main

Commercial Status	Commercialised
Range of product	Altistart 22
Product or component type	Soft starter
Product destination	Asynchronous motors
Product specific application	Severe and standard applications
Component name	ATS22
Network number of phases	3 phases
Power supply voltage	208...600 V (- 15...10 %)
Motor power hp	400 hp at 575 V 350 hp at 460 V 150 hp at 208 V
Factory setting current	414 A
Power dissipation in W	218 W for standard applications
Utilisation category	AC-53A
Type of start	Start with torque control (current limited to 3.5 In)
Icl nominal current	480 A (connection in the motor supply line) for standard applications
IP degree of protection	IP00

Complementary

Assembly style	With heat sink
Function available	Internal bypass
Power supply voltage limits	177...660 V
Power supply frequency	50...60 Hz (- 10...10 %)
Network frequency	45...66 Hz
Device connection	In the motor supply line
Control circuit voltage	110...115 V -15...10 % at 50/60 Hz
Control circuit consumption	20 W
Discrete output number	2
Discrete output type	(R2)Relay outputs 230 V running, alarm, trip, stopped, not stopped, starting, ready, C/O (R1)Relay outputs 230 V running, alarm, trip, stopped, not stopped, starting, ready, C/O
Minimum switching current	Relay outputs 100 mA at 12 V, DC
Maximum switching current	Relay outputs 2 A at 30 V, DC inductive load, L/R = 7 ms Relay outputs 2 A at 250 V, AC inductive load, cos phi = 0.4, L/R = 20 ms Relay outputs 5 A at 30 V, DC resistive load, cos phi = 1 Relay outputs 5 A at 250 V, AC resistive load, cos phi = 1
Discrete input number	3
Discrete input type	(LI1, LI2, LI3)logic 5 mA 20 kOhm
Discrete input voltage	110 V (<= 121 V)
Discrete input logic	(LI1, LI2, LI3)positive logic state 0 < 20 V and < 15 mA state 1 > 79 V and > 2 mA
Output current	0.4...1 Icl adjustable
PTC probe input	750 Ohm
Communication port protocol	Modbus
Connector type	1 RJ45
Communication data link	Serial
Physical interface	RS485 multidrop

Transmission rate	4800, 9600 or 19200 bps
Max nodes number	31
Protection type	Thermal protection on starter Thermal protection on motor Phase failure on line
Marking	CE
Type of cooling	Forced convection
Operating position	Vertical +/- 10 degree
Height	455 mm
Width	304 mm
Depth	339.7 mm
Product weight	50 kg

Environment

Electromagnetic compatibility	Voltage/Current impulse conforming to IEC 61000-4-5 level 3 Immunity to radiated radio-electrical interference conforming to IEC 61000-4-3 level 3 Immunity to electrical transients conforming to IEC 61000-4-4 level 4 Electrostatic discharge conforming to IEC 61000-4-2 level 3 Damped oscillating waves conforming to IEC 61000-4-12 level 3 Conducted and radiated emissions conforming to IEC 60947-4-2 level A
Standards	EN/IEC 60947-4-2
Product certifications	CCC CSA C-Tick GOST UL
Vibration resistance	1.5 mm (f = 2...13 Hz) conforming to EN/IEC 60068-2-6 1 gn (f = 13...200 Hz) conforming to EN/IEC 60068-2-6
Shock resistance	15 gn for 11 ms conforming to EN/IEC 60068-2-27
Noise level	56 dB
Pollution degree	Level 2 conforming to IEC 60664-1
Relative humidity	<= 95 % without condensation or dripping water conforming to EN/IEC 60068-2-3
Ambient air temperature for operation	> 40...< 60 °C with current derating 2.2 % per °C -10...40 °C without derating
Ambient air temperature for storage	-25...70 °C
Operating altitude	> 1000...< 2000 m with current derating of 2.2 % per additional 100 m <= 1000 m without derating

RoHS compliance

RoHS EUR status	Compliant
RoHS EUR conformity date(YYWW)	0939

Contractual warranty

Period	18 months
--------	-----------

Frame Size E

Dimensions

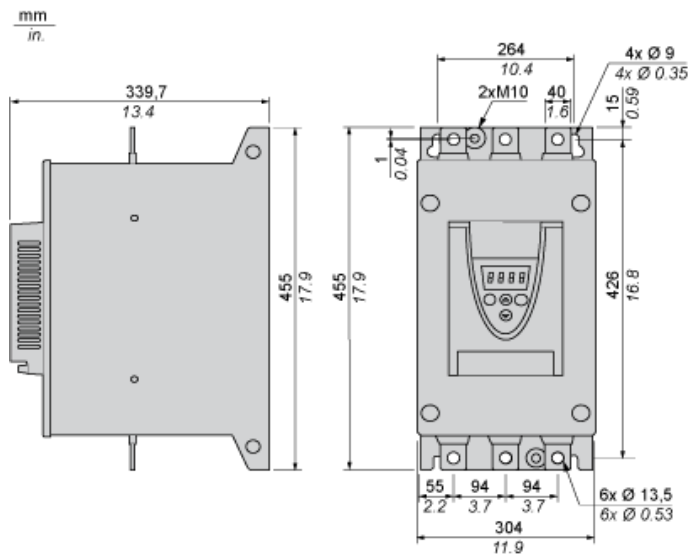

Precautions

Standards

The Altistart 22 soft starter is compliant with pollution Degree 2 as defined in NEMA ICS1-1 or IEC 60664-1.
For environment pollution degree 3, install the Altistart 22 soft starter inside a cabinet type 12 or IP54.

 DANGER

HAZARD OF ELECTRIC SHOCK, EXPLOSION, OR ARC FLASH

ATS22 soft starters are open devices and must be mounted in a suitable enclosure.

Failure to follow these instructions will result in death or serious injury.

Air Circulation

Leave sufficient free space to help the air required for cooling purposes to circulate from the bottom to the top of the unit.

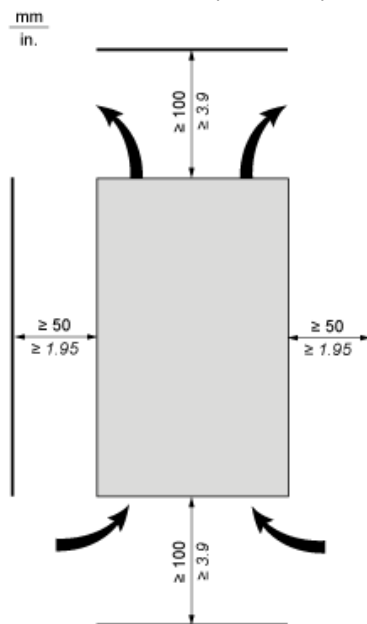

Overheating

To avoid the soft starter to overheat, respect the following recommendations:

- Mount the Altistart 22 Soft Starter within $\pm 10^\circ$ of vertical.
- Do not locate the Altistart 22 Soft Starter near heat radiating elements.
- Electrical current through the Altistart 22 Soft Starter will result in heat losses that must be dissipated into the ambient air immediately surrounding the soft starter. To help prevent a thermal fault, provide sufficient enclosure cooling and/or ventilation to limit the ambient temperature around the soft starter.
- If several soft starters are installed in a control panel, arrange them in a row. Do not stack soft starters. Heat generated from the bottom soft starter can adversely affect the ambient temperature around the top soft starter.

Wall mounted or Floor-standing Enclosure with IP 23 Degree of protection

Introduction

To help proper air circulation in the soft starter, grilles and forced ventilation can be installed.

Ventilation Grilles

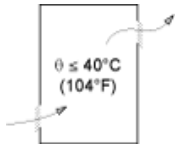

Forced Ventilation Unit

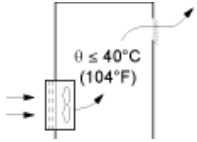

Power Terminal

Bar Style

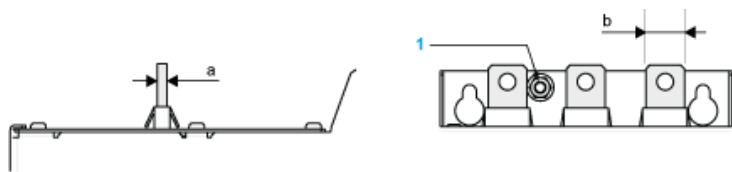

Power supply and output to motor	Bar	b	40 mm (1.18 in)
a	5 mm (0.2 in)		
Bolt	M12 (0.47 in)		
Cable and protective cover	Size	2X240 mm ²	
Gauge	2X500 MCM		
Protective cover	LA9F703		
Tightening torque	57 N.m		
498.75 lb.in			

Power connections, minimum required wiring section

IEC cable mm ² (Cu 70°C/158°F) (1)	UL cable AWG (Cu 75°C/167°F) (1)
2 X 150	3 X 350 MCM

110 Vac control, Logic Inputs (LI) 110 Vac, 3-wire control

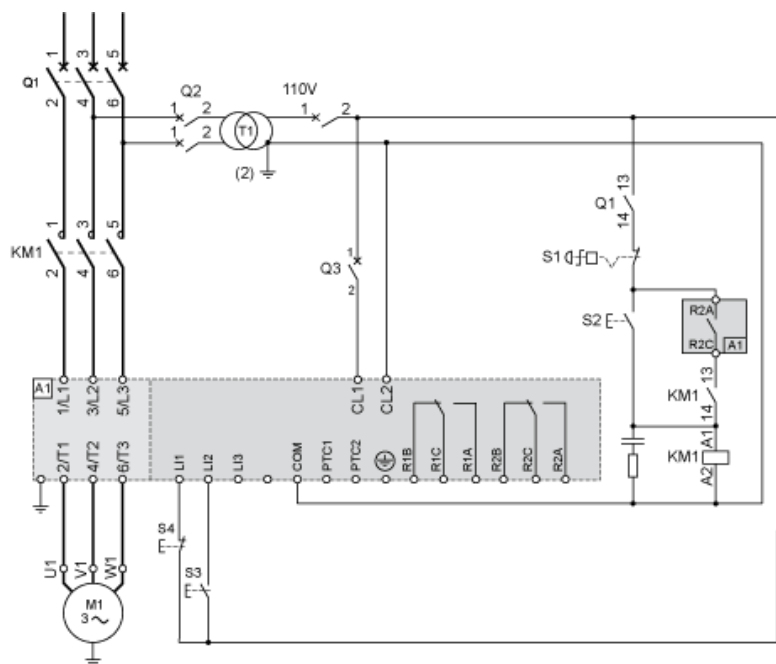

110 Vac control, Logic Inputs (LI) 110 Vac, 2-wire control, freewheelstop

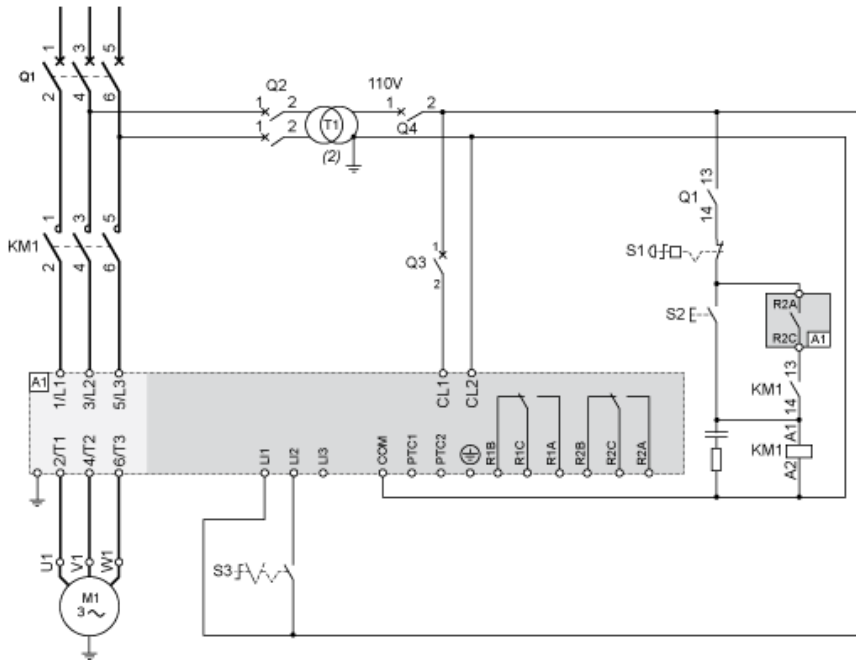

Motor Thermal Protection - Cold Curves

Curves

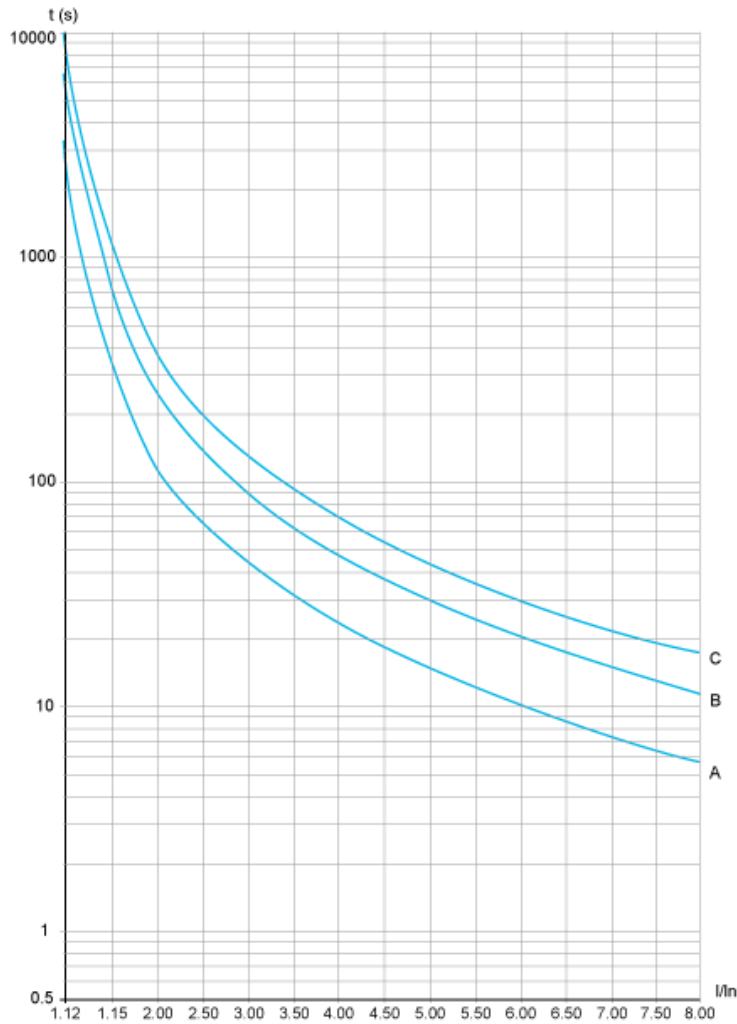

- A Class 10
- B Class 20
- C Class 30

Trip time for a Standard Application (Class 10)

3.5 In
32 s

Trip time for a Severe Application (Class 20)

3.5 In
63 s

Trip time for a Severe Application (Class 30)

3.5 In
95 s

Curves



- A Class 10
- B Class 20
- C Class 30

Trip time for a Standard Application (Class 10)

3.5 In
16 s

Trip time for a Severe Application (Class 20)

3.5 In
32 s

Trip time for a Severe Application (Class 30)

3.5 In
48 s