

Solid-state Counter H7CN

CSM_H7CN_DS_E_1_2



All Required Counter Functions Incorporated in a Compact DIN-sized (48 × 48) Housing

- In addition to Up and Down models, a reversible (Up-Down) counter is also available
- Maximum counting speed of 5,000 cps, never before attained by a small-size preset counter
- Power supply freely selectable within a range of 100 to 240 VAC. Also, power supply for the DC-operated models is selectable within a range of 12 to 48 V
- Models with memory backup function against power failure available



For the most recent information on models that have been certified for safety standards, refer to your OMRON website.

Ordering Information

Classification		Preset Counter								Totalizing Counter
Input signal system (Count & reset inputs)		Contact, Solid-state								Contact/Solid-state
Mounting method		Flush mounting, surface mounting								
Display		7-segment LEDs (8 mm high), Up indicator								7-segment LEDs (8 mm high)
Number of digits		4 digits (0 to 9,999)								
Backup power for memory protection		No		Yes (100 to 240 VAC only)		No		Yes		
Control output		Contact (SPST-NO)		Contact (SPDT)		Contact (SPST-NO)		Solid-state (open-collector)		---
Operating mode		Up counting	Down counting	Up counting	Down counting	Reversible counting, command input	Reversible counting, individual input	Up counting	Down counting	Up counting
Max. counting speed	30 cps	H7CN-XLN	H7CN-YLN	H7CN-XLNM	H7CN-YLNM	H7CN-ALN	H7CN-BLN	---	---	H7CN-TXL
	5 kcps (see note 1.)	H7CN-XHN	H7CN-YHN	H7CN-XHNM	H7CN-YHNM	H7CN-AHN	H7CN-BHN	H7CN-XHNS	H7CN-YHNS	H7CN-TXH

- Note:** 1. Only the solid-state input signal is available when the maximum counting speed is 5,000 cps
2. Specify the power supply voltage when ordering.

Accessories (Order Separately)

Protective Cover	Hard	Y92A-48B
	Soft	Y92A-48D
Flush Mounting Adapter		Y92F-30

Sockets

Applicable Counter	Track Mounted Socket	Back Connecting Socket
H7CN-□□	P2CF-08	P3G-08
H7CN-□□IM	P2CF-11	P3GA-11

Specifications

■ Ratings

Supply voltage	24, 100 to 240 VAC 50/60 Hz 12 to 48 VDC (contains 20% ripple max.) (see note 1)
Operating voltage range	85% to 110% of rated voltage
Power consumption (see note 2)	Approx. 12 VA/2.5 W (at 240 VAC, 50Hz) Approx. 2.5 W (at 48 VDC)
Count and reset input	Impedance by short-circuiting contacts: 1 kΩ max. Residual voltage: 2 V max. Impedance by opening contacts: 100 kΩ min.
Max. counting speeds of count input	30 cps (contact and solid-state inputs) Minimum pulse width: 16.7 ms (ON/OFF ratio: 1:1) 5,000 cps (solid-state inputs) Minimum pulse width: 0.1 ms (ON/OFF ratio: 1:1)
Reset system	Power-OFF reset Reset time: 0.5 s Reset time following power application 0.05 s External reset & manual reset Reset time: 0.02 s Reset time following signal application: 0.05 s
Control output	Contact (SPDT) output: 3 A, 250 VAC, $\cos\phi = 1$ (resistive load) Solid-state (open collector) output: 30 VDC MAX. 100 mA max.

Note: 1. The memory backup function is not available for this DC supply voltage range.

2. On power application, an inrush current of approximately 10 times the normal current flows through the Counter.

■ Characteristics

Item	Preset Counter	Totalizing Counter
Insulation resistance	100 MΩ min. (at 500 VDC) (between current-carrying terminal and exposed non-current-carrying metal parts, and between non-continuous contacts)	100 MΩ min. (at 500 VDC) (between current-carrying terminal and exposed non-current-carrying metal parts)
Dielectric strength	2,000 VAC, 50/60 Hz for 1 min (between current-carrying terminal and exposed non-current carrying metal parts and between non-continuous contacts)	2,000 VAC, 50/60 Hz for 1 min (between current-carrying terminal and exposed non-current carrying metal parts)
Impulse withstand voltage	6 kV (between power terminals) 6 kV (between current-carrying terminal and exposed non-current-carrying metal parts)	
Noise immunity	±2 kV (between power terminals), ±500 V (between input terminals), square-wave noise by noise simulator	
Static immunity	Malfunction: 8 kV	
Vibration resistance	Destruction: 10 to 55 Hz, 0.75-mm single amplitude Malfunction: 10 to 55 Hz, 0.5-mm single amplitude	
Shock resistance	Destruction: 300 m/s ² (approx. 30G) Malfunction: 100 m/s ² (approx. 10G)	
Ambient temperature	Operating: -10°C to 55°C (with no icing) Storage: -25°C to 65°C (with no icing)	
Ambient humidity	35% to 85%	
Life expectancy	Mechanical: 10 million operations min. Electrical: 100,000 operations min. (3 A at 250 VAC, resistive load)	---
Approved standards	UL508, CSA C22.2 No.14	
Weight	Approx. 150 g	

Engineering Data

Electrical Life Expectancy

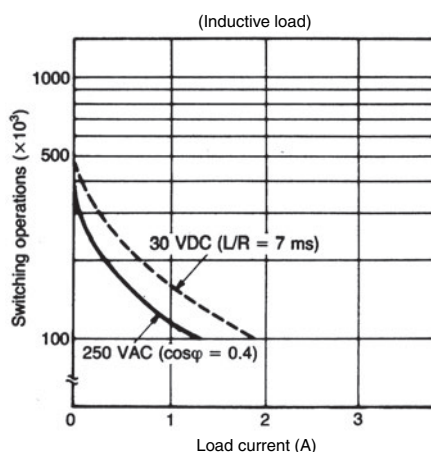
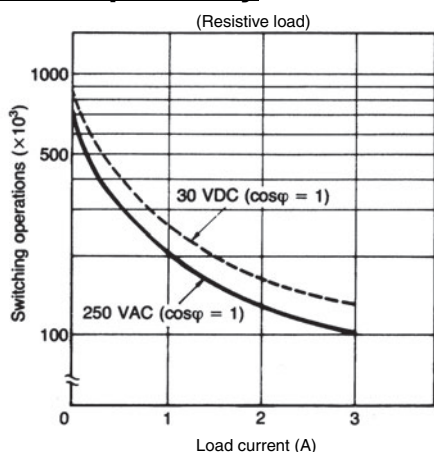

Operation

■ Timing Charts

Preset Counter

Up Type

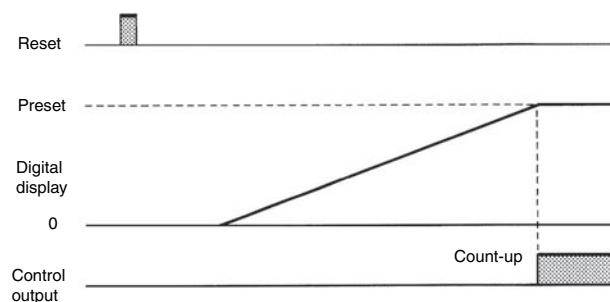

Down Type

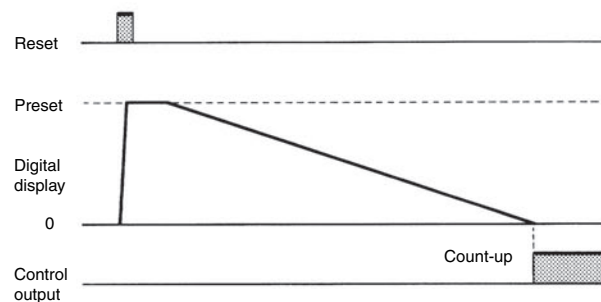

Up/Down A, B Types

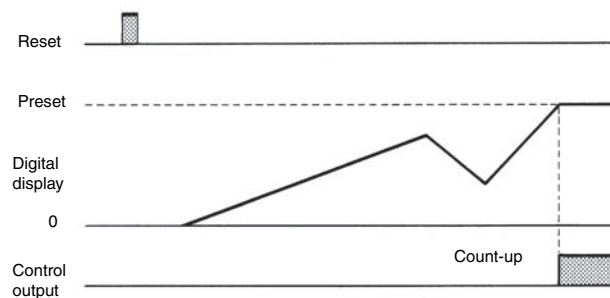

Totalizing Counter

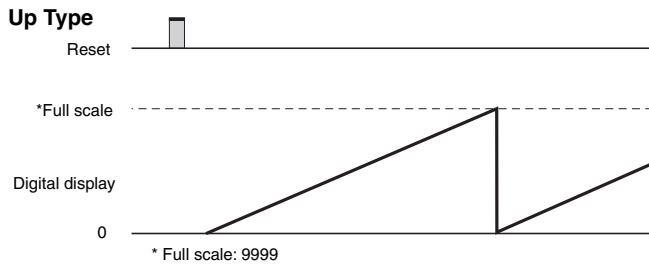

Input Mode

Up/Down Selectable Type

Note: (A) must be more than the minimum signal width. If (A) is set shorter than the minimum signal width, the error of count ± 1 may occur.

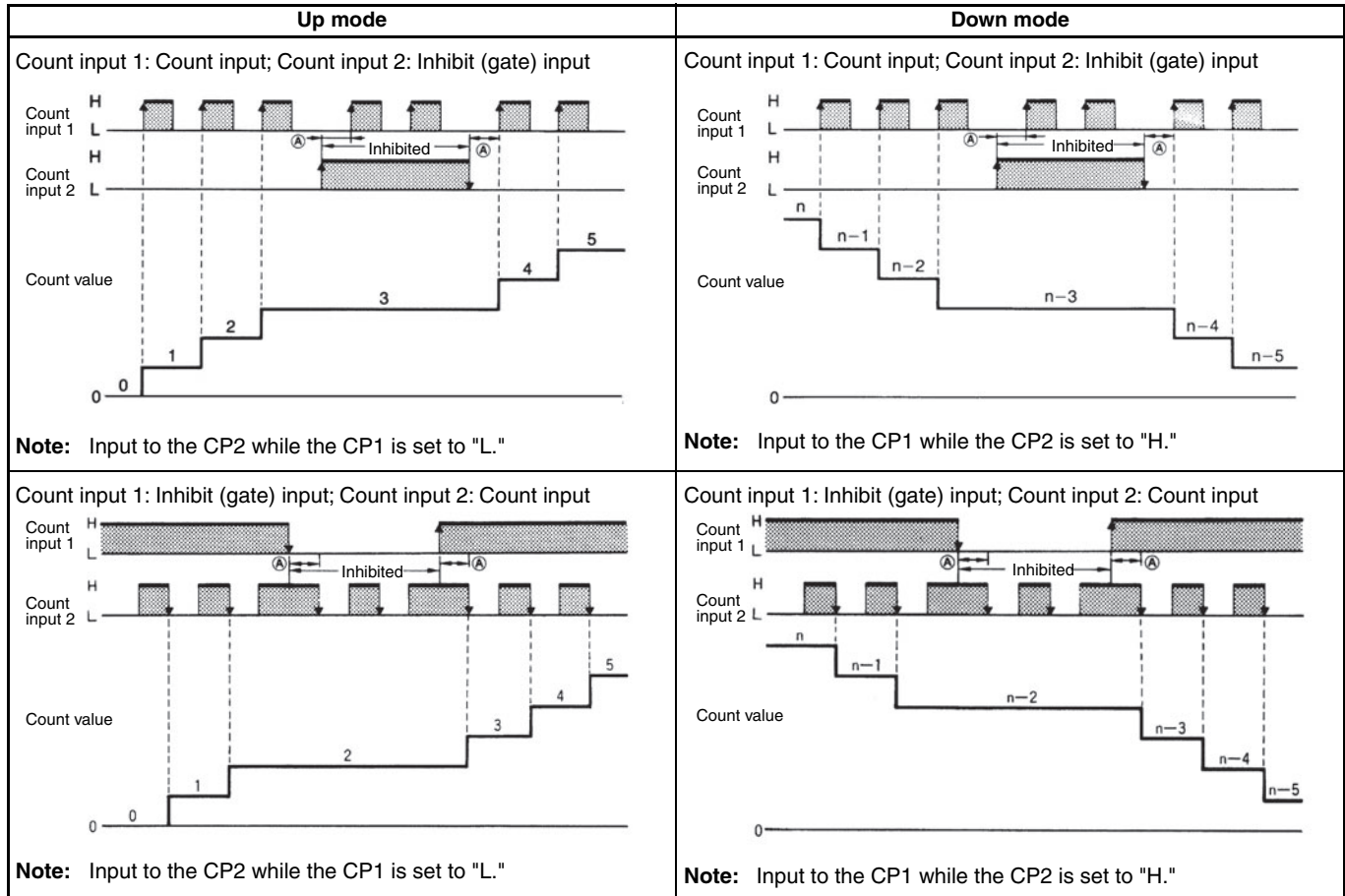

Up/Down Type

Note: A) must be more than the minimum signal width. If (A) is set shorter than the minimum signal width, the error of count ± 1 may occur.

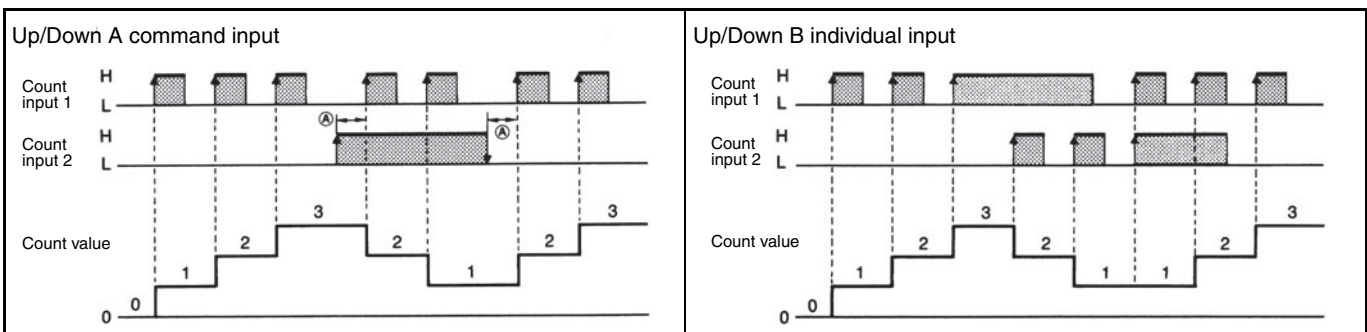

H: Short-circuit ON-time impedance; 1 k Ω max. Residual voltage; 0.5 V max.
 L: Open circuit OFF-time impedance; 100 k Ω min.

Dimensions

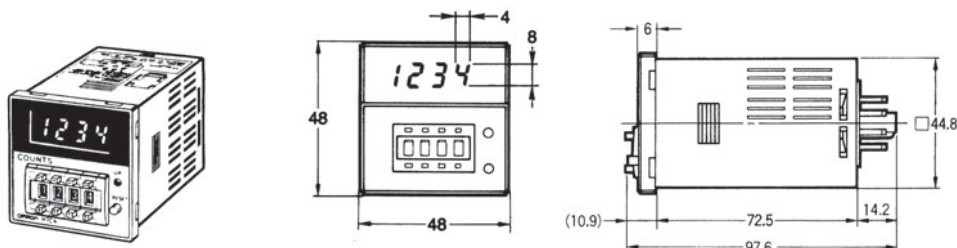

Accessories

Adapter for Flush Mounting

Y90F-30

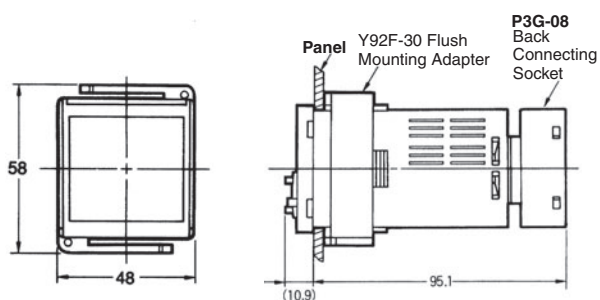

Panel Cutout

The standard panel cutout is as shown below. (Panel cutout conforms to DIN43700.)

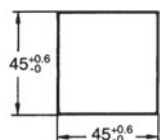

Panel cutout for side-by-side mounting of two or more Units

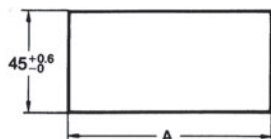

When mounting n Counters in a line, dimension A can be calculated from following formula.

$$A = (48n - 2.5) \pm 0.1$$

Connecting Sockets

H7CN

Front Mounting

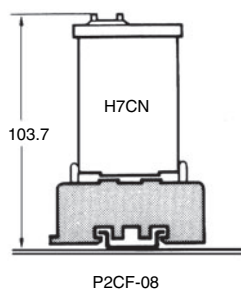

Flush Mounting

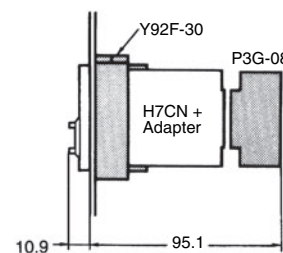

H7CN-□□NM

Front Mounting

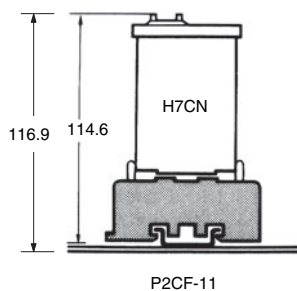

Flush Mounting

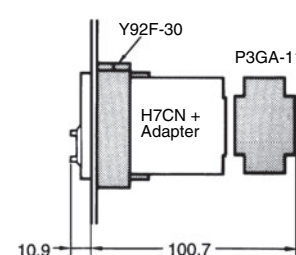

Protective Cover

The Protective Cover shields the front panel, particularly the count value setting section from dust, dirt and water, and prevent malfunctioning of the Counter due to static electricity.

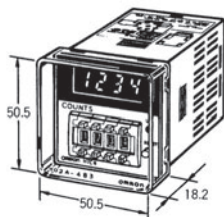

Y92A-48B (Hard cover)
(see note 1)



Y92A-48D (Soft cover)
(see note 2)

- Note:**
1. The Hard Protective Cover prevents the set count value from being altered due to accidental contact with the push-type thumbwheel switch.
 2. The Soft Protective Cover allows the set value to be set by depressing the thumbwheel switches through it. It may be, however, difficult to make setting changes of the Counter with the Y92A-48B Protective Cover attached, which must be taken into consideration before using the Y92A-48B Protective Cover.

Installation

Terminal Arrangement

Presetting Model (with No Backup Function)

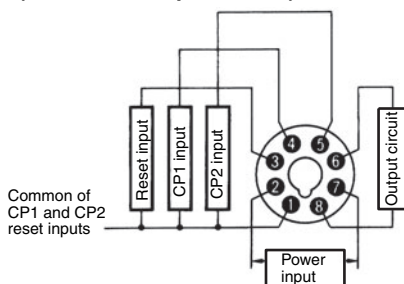

Presetting Model (with Backup Function)

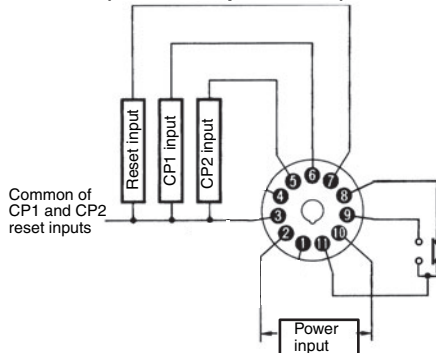

Totalizing Model (with No Backup Function)

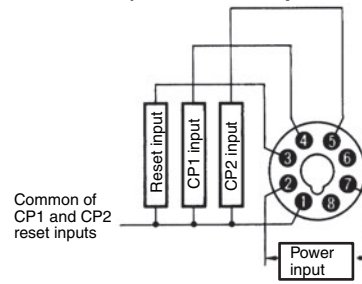

- Note:**
1. Terminal 2 is a negative terminal and terminal 7 is a positive terminal if DC power is supplied.
 2. Common terminal 1 is internally connected to terminal 2 if the Counter is a model that operates with DC.

- Note:**
1. Terminal 2 is a negative terminal and terminal 7 is a positive terminal if DC power is supplied.
 2. Common terminal 1 is internally connected to terminal 2 if the Counter is a model that operates with DC.

Connections

Power Supply Connection

For Models with No Backup Function

AC Power Supply

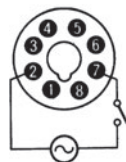

100 to 240 VAC

DC Power Supply

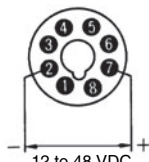

12 to 48 VDC

For Models with Backup Function

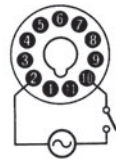

100 to 240 VAC

- Note:**
1. Make sure that the fluctuation of the supply voltage is within the permissible range.
 2. Pay attention to the polarity of the DC power supply and do not make a wiring mistake.

Input Connection

The CP1 and CP2 reset inputs of the H7CN will be active when input to the H7CN is short-circuited.

Solid-state Input (NPN)

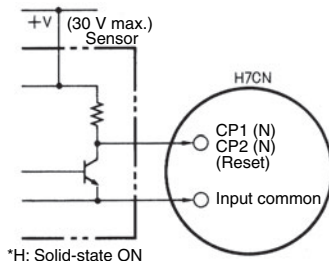
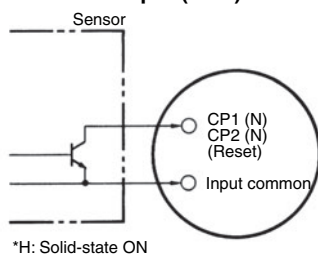

Contact Input

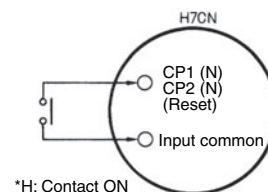

* Refer to the following for the signal levels of the solid-state input.

- Note:**
1. H level with solid-state ON. Residual voltage: 2 V max. ON impedance: 1 kΩ max.
 2. L level with solid-state OFF. OFF impedance: 100 kΩ min.

* Sensors with voltage output can be connected to the H7CN as shown in the above circuit diagram. When solid-state is OFF, make sure that the voltage between the input common and CP1 or CP2 terminals are 4 V min. for AC models and 6 V min. for DC models.

* Make sure that the contact can switch 0.5 mA at 5 V with ease.

Output (Load) Connection

Contact Output

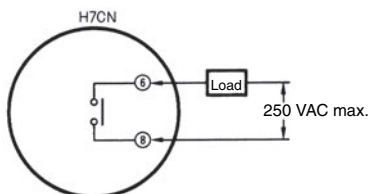

Solid-state Output

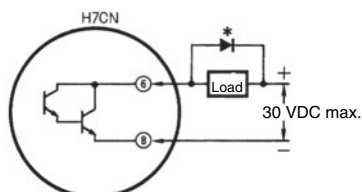

*Diode to absorb counter-electromotive force

Delay Time

The delay time, which is the period between the moment a pulse input signal that coincides with the preset value is ON and the moment the corresponding control output signal is ON, varies with the counting speed and type of output as shown in the following table.

Control output	Max. counting speed	Delay time
Contact output	30 Hz (cps)	12.5 to 15.0 ms
	5 kHz (cps)	4.0 to 5.5 ms
Solid-state output	5 kHz (cps)	0.05 to 0.25 ms

Safety Precautions

Refer to *Safety Precautions for All Counters*.

CAUTION

Do not touch the terminals while power is being supplied. Doing so may occasionally result in minor injury due to electric shock. 

Do not touch the terminals within one minute after turning OFF the power supply. Doing so may occasionally result in minor injury due to electric shock. 

Do not use the product where subject to flammable or explosive gas. Otherwise, minor injury from explosion may occasionally occur. 

Do not attempt to disassemble, modify, or repair the product or touch any of the internal parts. Minor electric shock, fire, or malfunction may occasionally occur. 

The service life of output relays depends on the switching capacity and switching conditions. Be sure to consider the actual application conditions and use the product within the rated load and electrical service life. Using the product beyond its service life may occasionally result in contact welding or burning. 

Tighten the screws to between 0.74 and 0.90 N·m. Loose screws may occasionally result in fire. 

Do not allow pieces of metal, wire clippings, or fine metallic shavings from installation to enter the product. Doing so may occasionally result in electric shock, fire, or malfunction. 

Precautions for Safe Use

- The construction of the product is not resistant to water or oil. Do not use the product where it is subject to exposure to water or oil.
- Use the product within the rated load.
- Do not directly apply external voltage to the transistor output terminals.
- Always use a thermoswitch on the load circuit when a heater is used.
- Turn the power supply voltage ON and OFF through a relay, switch, or other contact so that the voltage is reached immediately. Gradually applying voltage may result in malfunction.
- Use the specified wires for wiring. Applicable wire: AWG18 to AWG24 (cross-sectional area: 0.205 to 0.823 mm²).
- Up to two crimp terminals can be inserted into a single terminal.
- Do not connect anything to unused terminals.
- Leaving the product with outputs ON at a high temperature for a long time may hasten the degradation of internal parts (such as electrolytic capacitors). Therefore, use the product in combination with a relay and do not leave the product for a long time (e.g., one month) with the outputs ON.
- A constant reading system is used in the preset counter, so settings can be changed while power is being supplied, but the output will turn ON if the set value is set to the current measurement value.
- Internal circuit voltage (5 V) is output to the no-voltage input terminals, which may cause some connected devices to malfunction or fail. Check the specifications of the input device (e.g., rated output voltage or whether a power supply circuit diode is built in). To prevent power supply devices from being subjected to charging accidents, connect a diode as in the diagram when using a power supply voltage of 5 V or less to operate input devices that do not have a diode built into the power supply circuit

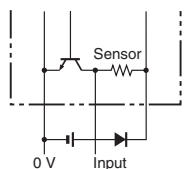

- When settings are changed while power is being supplied, the settings will become extremely unstable if the thumb rotary switch is left pressed halfway such that two numbers are visible in the number display window.

Precautions for Correct Use

- Be sure that the capacity of the power supply, breaker, and contacts are large enough. Otherwise, the Counter may not start due to inrush current (approx. 0.8 A) that may flow for an instant when the power supply is turned ON.
- Operation may not be performed in response to the input signal for a period of 50 ms after the power supply is turned ON. This time is required for the internal circuit voltage to rise.
- Operation may still be performed in response to the input signal for a period of 50 ms even after the power supply is turned OFF. This time is required for the internal circuit voltage to drop.

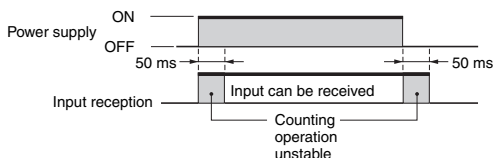

- Models without power failure memory backup will operate as shown in the following figure if the power supply is momentarily interrupted.

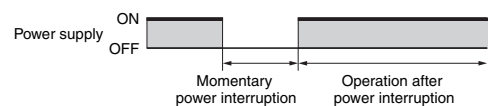

0.5 s min.	Displays and outputs will be reset.
0.01 s max.	The status before the power interruption will be held.
0.01 to 0.5 s	Operation will be unstable, i.e., one of the above operations will be performed.

Note: Use a Counter with power failure backup memory (models ending with -M) if holding the status before the power failure is required when the power is interrupted.

- All number display digits on the Counter will be OFF when the signal is input for an external or manual reset.

Power Failure Backup Memory

EEP-ROM is used to back up the memory if the power fails. The data is written to the EEPROM when the power is turned OFF.

Self-diagnostic Function

The following will be displayed if an error occurs.

Seven-segment display	Reset indicator	Count-out indicator	Description	Output status
E1	OFF	OFF	CPU error	OFF
E2	OFF	OFF	RAM memory error	OFF
E3	OFF	OFF	EEPROM memory error	OFF

Try correcting the error by cycling the power supply. If the indications do not change, try inputting the reset signal. If that does not work, the Counter will need to be repaired. If normal operation is recovered, it might have been caused by noise. Check for noise generation.

ALL DIMENSIONS SHOWN ARE IN MILLIMETERS.
To convert millimeters into inches, multiply by 0.03937. To convert grams into ounces, multiply by 0.03527.

In the interest of product improvement, specifications are subject to change without notice.

Read and Understand This Catalog

Please read and understand this catalog before purchasing the products. Please consult your OMRON representative if you have any questions or comments.

Warranty and Limitations of Liability

WARRANTY

OMRON's exclusive warranty is that the products are free from defects in materials and workmanship for a period of one year (or other period if specified) from date of sale by OMRON.

OMRON MAKES NO WARRANTY OR REPRESENTATION, EXPRESS OR IMPLIED, REGARDING NON-INFRINGEMENT, MERCHANTABILITY, OR FITNESS FOR PARTICULAR PURPOSE OF THE PRODUCTS. ANY BUYER OR USER ACKNOWLEDGES THAT THE BUYER OR USER ALONE HAS DETERMINED THAT THE PRODUCTS WILL SUITABLY MEET THE REQUIREMENTS OF THEIR INTENDED USE. OMRON DISCLAIMS ALL OTHER WARRANTIES, EXPRESS OR IMPLIED.

LIMITATIONS OF LIABILITY

OMRON SHALL NOT BE RESPONSIBLE FOR SPECIAL, INDIRECT, OR CONSEQUENTIAL DAMAGES, LOSS OF PROFITS OR COMMERCIAL LOSS IN ANY WAY CONNECTED WITH THE PRODUCTS, WHETHER SUCH CLAIM IS BASED ON CONTRACT, WARRANTY, NEGLIGENCE, OR STRICT LIABILITY.

In no event shall the responsibility of OMRON for any act exceed the individual price of the product on which liability is asserted.

IN NO EVENT SHALL OMRON BE RESPONSIBLE FOR WARRANTY, REPAIR, OR OTHER CLAIMS REGARDING THE PRODUCTS UNLESS OMRON'S ANALYSIS CONFIRMS THAT THE PRODUCTS WERE PROPERLY HANDLED, STORED, INSTALLED, AND MAINTAINED AND NOT SUBJECT TO CONTAMINATION, ABUSE, MISUSE, OR INAPPROPRIATE MODIFICATION OR REPAIR.

Application Considerations

SUITABILITY FOR USE

OMRON shall not be responsible for conformity with any standards, codes, or regulations that apply to the combination of products in the customer's application or use of the products.

At the customer's request, OMRON will provide applicable third party certification documents identifying ratings and limitations of use that apply to the products. This information by itself is not sufficient for a complete determination of the suitability of the products in combination with the end product, machine, system, or other application or use.

The following are some examples of applications for which particular attention must be given. This is not intended to be an exhaustive list of all possible uses of the products, nor is it intended to imply that the uses listed may be suitable for the products:

- Outdoor use, uses involving potential chemical contamination or electrical interference, or conditions or uses not described in this catalog.
- Nuclear energy control systems, combustion systems, railroad systems, aviation systems, medical equipment, amusement machines, vehicles, safety equipment, and installations subject to separate industry or government regulations.
- Systems, machines, and equipment that could present a risk to life or property.

Please know and observe all prohibitions of use applicable to the products.

NEVER USE THE PRODUCTS FOR AN APPLICATION INVOLVING SERIOUS RISK TO LIFE OR PROPERTY WITHOUT ENSURING THAT THE SYSTEM AS A WHOLE HAS BEEN DESIGNED TO ADDRESS THE RISKS, AND THAT THE OMRON PRODUCTS ARE PROPERLY RATED AND INSTALLED FOR THE INTENDED USE WITHIN THE OVERALL EQUIPMENT OR SYSTEM.

PROGRAMMABLE PRODUCTS

OMRON shall not be responsible for the user's programming of a programmable product, or any consequence thereof.

Disclaimers

CHANGE IN SPECIFICATIONS

Product specifications and accessories may be changed at any time based on improvements and other reasons.

It is our practice to change model numbers when published ratings or features are changed, or when significant construction changes are made. However, some specifications of the products may be changed without any notice. When in doubt, special model numbers may be assigned to fix or establish key specifications for your application on your request. Please consult with your OMRON representative at any time to confirm actual specifications of purchased products.

DIMENSIONS AND WEIGHTS

Dimensions and weights are nominal and are not to be used for manufacturing purposes, even when tolerances are shown.

PERFORMANCE DATA

Performance data given in this catalog is provided as a guide for the user in determining suitability and does not constitute a warranty. It may represent the result of OMRON's test conditions, and the users must correlate it to actual application requirements. Actual performance is subject to the OMRON Warranty and Limitations of Liability.

ERRORS AND OMISSIONS

The information in this document has been carefully checked and is believed to be accurate; however, no responsibility is assumed for clerical, typographical, or proofreading errors, or omissions.

2012.8

In the interest of product improvement, specifications are subject to change without notice.

OMRON Corporation
Industrial Automation Company

<http://www.ia.omron.com/>

(c)Copyright OMRON Corporation 2012 All Right Reserved.