

Heavy-duty Plug-in Photoelectric Sensor

E3S-C Plug-in

Water-resistive Photoelectric Sensor with Metal Housing & Plug-in Connector Ensuring Long Sensing Distance

- Satisfies the requirements of IP67, and NEMA6P.
- Ensures a vibration resistance of 10 Hz to 2 kHz and a shock resistance of 1,000 m/s² (approximately 100G).
- Incorporating an NPN and PNP output selector, thus reducing the stock of photoelectric sensors.
- Incorporating a fuzzy mutual interference prevention function.
- M12 plug-in connector provides easy mounting.



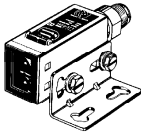
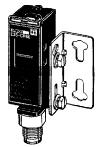

Ordering Information

■ E3S-C Plug-in Connector Model

| Connections | Appearance | Sensing method | Sensing distance | Operating mode | Model |
|-------------------|---|--------------------|----------------------------------|-------------------------------------|----------|
| Plug-in connector |  | Through-beam | 30 m | Light-ON Dark-ON (selectable) | E3S-CT16 |
| | | Retroreflective | 3 m (polarized red light source) | | E3S-CR16 |
| | | Diffuse reflective | 70 cm | | E3S-CD16 |
| | | | 2 m | | E3S-CD17 |
| |  | Through-beam | 30 m | | E3S-CT66 |
| | | Retroreflective | 3 m (polarized red light source) | | E3S-CR66 |
| | | Diffuse reflective | 70 cm | | E3S-CD66 |
| | | | 2 m | | E3S-CD67 |

■ Accessories (Order Separately)

I/O Connector

| Appearance | Cord | | Model |
|---|------|---------------------|-----------------|
|  | 2 m | 3-wired | XS2F-D421-DC0-A |
| | 5 m | 3-wired | XS2F-D421-GC0-A |
|  | 2 m | 4-wired | XS2W-D421-D81-A |
| | 5 m | 4-wired | XS2W-D421-G81-A |
|  | 5 m | 4-point input (NPN) | XW3A-P445-G11 |
| | | 4-point input (PNP) | XW3A-P443-G11 |

■ Accessories (Order Separately)

For E3S-C

| Name | Model | Remarks |
|------------------------------|---------|---|
| Slit for Through-beam Sensor | E39-S61 | A set consisting of a 0.5-mm, 1-mm, 2-mm, and 4-mm slits. |

Specifications

Plug-in Connector Models

| Item | Through-beam | Retroreflective | Diffuse reflective | |
|-------------------------------|---|---|---|----------------------|
| | E3S-CT16 E3S-CT66 | E3S-CR16 E3S-CR66 | E3S-CD16 E3S-CD66 | E3S-CD17 E3S-CD67 |
| LED for emitter | Infrared LED (880 nm) | Red LED (700 nm) | Infrared LED (880 nm) | |
| Sensitivity adjustment | One-turn adjustor | | Two-turn endless adjustor with an indicator | |
| Connection method | Plug-in connector | | | |
| Weight | Horizontal model: approx. 71 g Vertical model: approx. 76 g | | | |
| Output configuration | NPN or PNP (selectable) open collector current output | | | |
| Control output | Light ON or Dark ON (selectable) | | | |
| Circuit protection | Load short-circuit protection, reversed connection protection, and mutual interference prevention function (except for through-beam models) | | | |
| Indicator | Emitter: operating indicator (red) Receiver: stability indicator (green), emission indicator (red) | Stability indicator (green), emission indicator (red) | | |
| Materials | Case: Zinc die-cast Operation panel: Sulfonated polyether Lens: Acrylic Mounting bracket: Stainless | | | |
| Attachments | Mounting bracket, screw driver for adjustment, M4 hexagonal bolts, instruction sheet, and reflector (E39-R1: retroreflective model only) | | | |

■ Ratings/Characteristics

| Item | Through-beam | Retroreflective | Diffuse reflective | |
|--|--|---|------------------------------|--|
| | E3S-CT16 E3S-CT66 | E3S-CR16 E3S-CR66 | E3S-CD16 E3S-CD66 | E3S-CD17 E3S-CD67 |
| Power supply voltage | 10 to 30 VDC; ripple: 10% max. | | | |
| Current consumption | 50 mA max. (emitter and receiver) | 40 mA max. | | |
| Sensing distance (white paper) | 0 to 30 m | 0 to 3 m | 0 to 70 cm | 0 to 2 m |
| Standard sensing object | --- | With the E39-R1 | 30 x 30 cm (white paper) | |
| Variation in sensing distance | --- | | ±10% max. | |
| Hysteresis | --- | | 20% max. of sensing distance | |
| Sensing distance with attachment | 4-mm slit: 15 m 2-mm slit: 7 m 1-mm slit: 3.5 m 0.5-mm slit: 1.8 m | E39-R2: 0 to 4 m E39-R3: 0 to 150 cm E39-R4: 0 to 75 cm E39-RSA: 5 to 35 cm E39-RSB: 5 to 60 cm | --- | |
| Min. sensing object (see note) | 4-mm slit: 2.6-mm dia. 2-mm slit: 2-mm dia. 1-mm slit: 1-mm dia. 0.5-mm slit: 0.5-mm dia. | E39-R1 Reflector: 13-mm dia. E39-R3: 8-mm dia. E39-R4: 4-mm dia. | --- | |
| Difference in direction between optical axis and mounting direction | ±2° max. (checked along extended line in the mounting direction) | | ±2° max. | |
| Response time | 1 ms max. for both operation and release | | | 2 ms max. for both operation and release |
| Control output | 30 VDC, 100 mA max. (residual voltage: NPN output: 1.2 V max., PNP output: 2.0 V max.), open collector (NPN/PNP output selectable) | | | |
| Ambient illumination | Incandescent lamp: illumination on optical spot: 5,000 lx max. Sunlight: illumination on optical spot: 10,000 lx max. | | | |
| Ambient temperature | Operating: -25°C to 55°C (with no icing) | | | |
| Ambient humidity | Operating: 35% to 85% | | | |
| Insulation resistance | 20 MΩ min. (at 500 VDC) | | | |
| Dielectric strength | 1,000 VAC, 50/60 Hz for 1 min | | | |
| Vibration resistance | Destruction: 10 to 2,000 Hz, 1.5-mm double amplitude, or 300 m/s ² (approx. 30G) 0.5 hrs each in X, Y, and Z directions | | | |
| Shock resistance | Destruction: 1,000 m/s ² (approx. 100G) 3 times each in X, Y, and Z directions | | | |
| Enclosure ratings | IEC: IP67, NEMA*: 6P (indoors only). | | | |

*NEMA: National Electrical Manufacturers Association

Note: At the rated sensing distance, set a sensing object at half the rated sensing distance.

Engineering Data

Parallel Operating Range (Typical)

E3S-CTj 6

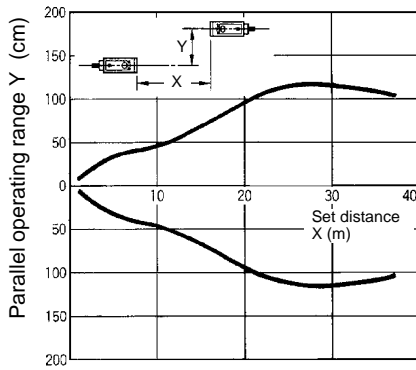

Operating Range (Typical)

E3S-CDj 6 (Left and Right)

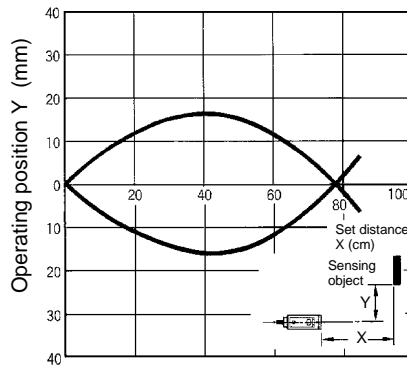

E3S-CDj 7 (Left and Right)

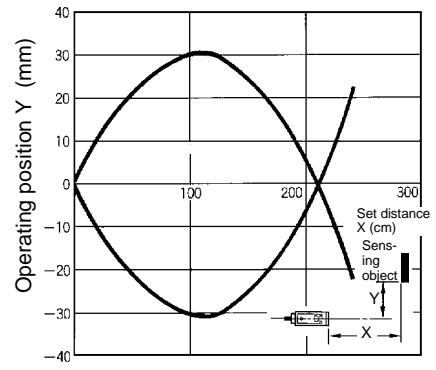

E3S-CDj 6 (Up and Down)

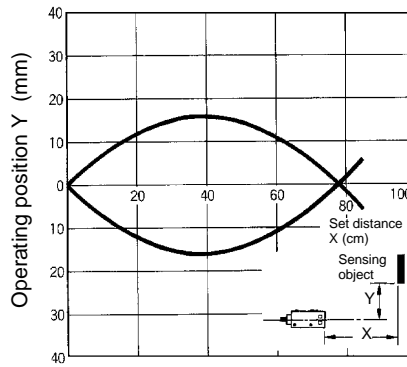

E3S-CDj 7 (Up and Down)

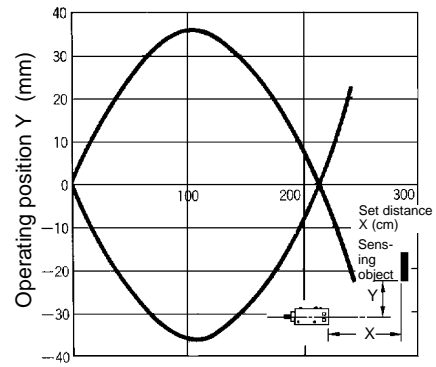

Sensing Distance vs. Object Size (Typical)

E3S-CDj 6

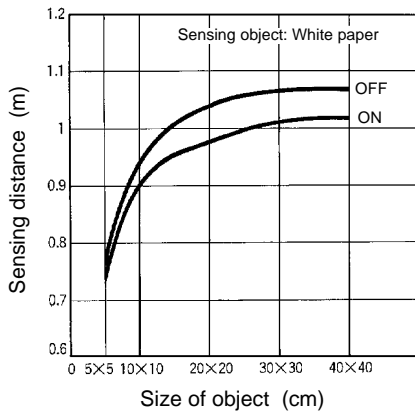

E3S-CDj 7

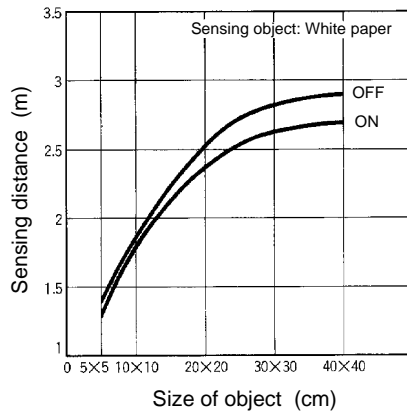

Reflector Parallel Movement (Typical)

E3S-CRj 6

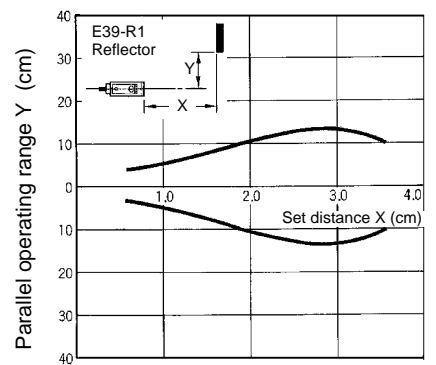

Excess Gain vs. Set Distance (Typical)

E3S-CTj 6

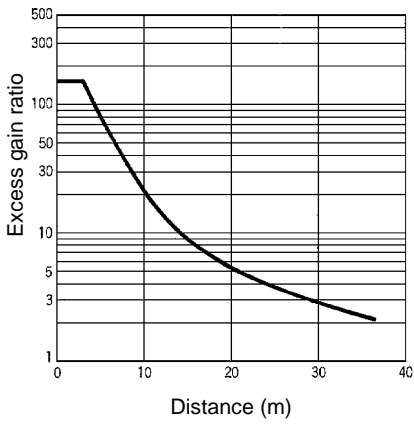

E3S-CRj 6 (E39-R1 Reflector)

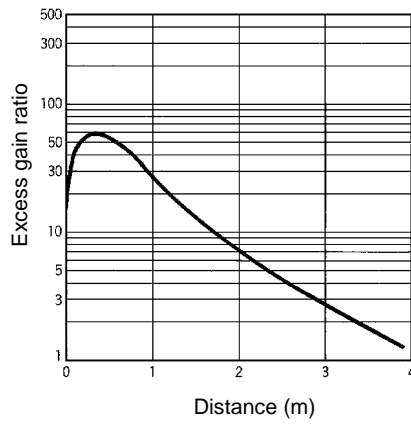

E3S-CDj 6

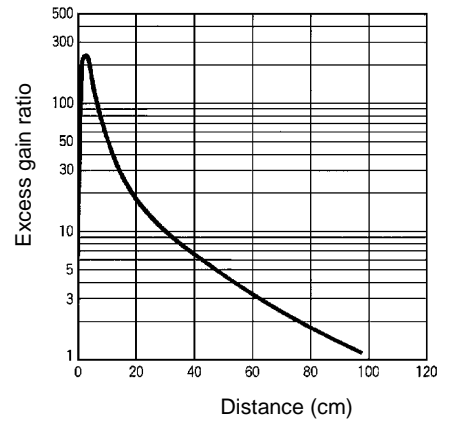

E3S-CDj 7

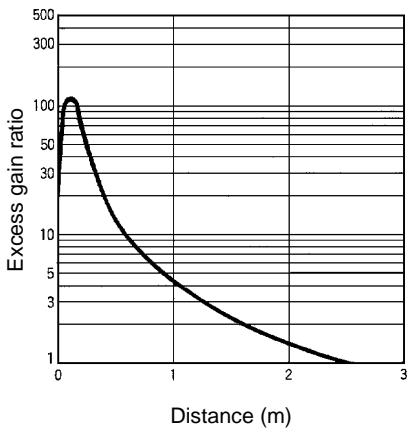

Nomenclature

Horizontal Model

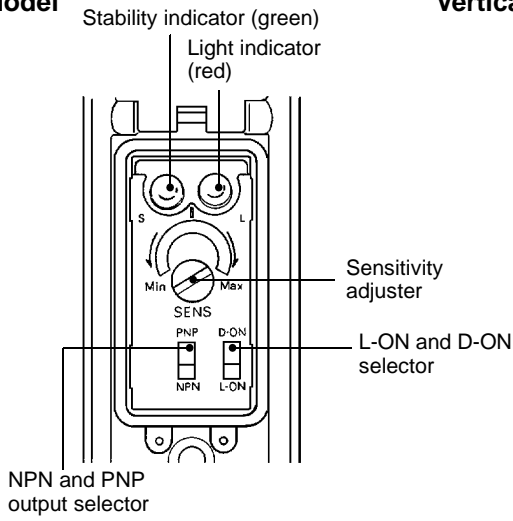

Vertical Model

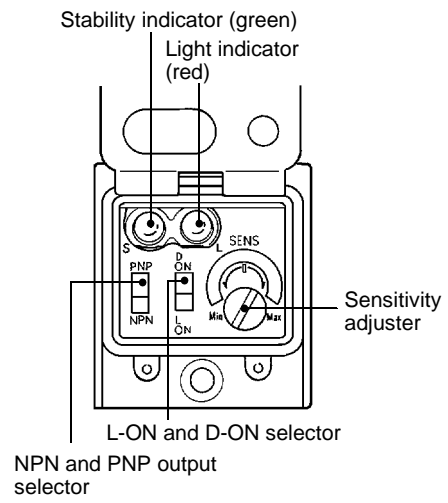

Operation Panel

Use the NPN and PNP output selector on the operation panel to select the type of output transistor.

Use the Light ON and Dark ON selector on the operation panel to select the operation mode of the E3S-C.

■ Output Circuits
Plug-in Connector Models

| Output configuration | Mode switch | Output transistor | Output circuits |
|----------------------|-------------|--------------------------------|--|
| NPN | Light ON | On when light is received. | <p>Reflective Type and Receiver</p> <p>ZD : $V_Z = 39\text{ V}$ Note: Set the NPN and PNP output selector to NPN.</p> <p>Emitter</p> <p>Connector Pin Arrangement</p> |
| | Dark ON | ON when light is not received. | <p>Reflective Type and Receiver</p> <p>ZD : $V_Z = 39\text{ V}$ Note: Set the NPN and PNP output selector to PNP.</p> <p>Emitter</p> <p>Connector Pin Arrangement</p> |
| PNP | Light ON | On when light is received. | <p>Reflective Type and Receiver</p> <p>ZD : $V_Z = 39\text{ V}$ Note: Set the NPN and PNP output selector to PNP.</p> <p>Emitter</p> <p>Connector Pin Arrangement</p> |
| | Dark ON | ON when light is not received. | <p>Reflective Type and Receiver</p> <p>ZD : $V_Z = 39\text{ V}$ Note: Set the NPN and PNP output selector to PNP.</p> <p>Emitter</p> <p>Connector Pin Arrangement</p> |

I/O Connector Plug

NPN Output

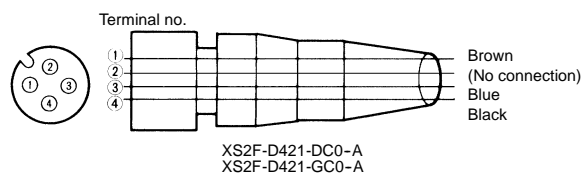



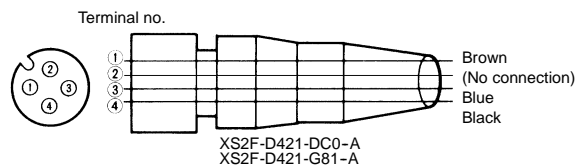

















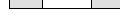

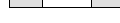







PNP Output

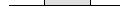

| NPN output | | | | PNP output | | | |
|------------|-----------|---------------|--------------------|------------|-----------|---------------|--------------------|
| Type | Conductor | Connector pin | Application | Type | Conductor | Connector pin | Application |
| DC | Brown | 1 | Power supply (+V) | DC | Brown | 1 | Power supply (+V) |
| | Black | 4 | Output | | Black | 4 | Output |
| | Blue | 3 | Power supply (0 V) | | Blue | 3 | Power supply (0 V) |
| | --- | 2 | No connection | | --- | 2 | No connection |

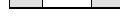
■ Timing Chart

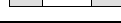
| Output configuration | Mode switch | Output transistor | Timing chart |
|----------------------|-------------|--------------------------------|--|
| NPN | Light ON | On when light is received. | <p>Light received </p> <p>Light not received </p> <p>Light indicator (Red) ON </p> <p>OFF </p> <p>Output transistor ON </p> <p>OFF </p> <p>Load (relay) Operate </p> <p>Release </p> <p>(Between terminals 1 and 4)</p> |
| | Dark ON | ON when light is not received. | <p>Light received </p> <p>Light not received </p> <p>Light indicator (Red) ON </p> <p>OFF </p> <p>Output transistor ON </p> <p>OFF </p> <p>Load (relay) Operate </p> <p>Release </p> <p>(Between terminals 1 and 4)</p> |
| PNP | Light ON | On when light is received. | <p>Light received </p> <p>Light not received </p> <p>Light indicator (Red) ON </p> <p>OFF </p> <p>Output transistor ON </p> <p>OFF </p> <p>Load (relay) Operate </p> <p>Release </p> <p>(Between terminals 3 and 4)</p> |
| | Dark ON | ON when light is not received. | <p>Light received </p> <p>Light not received </p> <p>Light indicator (Red) ON </p> <p>OFF </p> <p>Output transistor ON </p> <p>OFF </p> <p>Load (relay) Operate </p> <p>Release </p> <p>(Between terminals 3 and 4)</p> |

■ Fuzzy Mutual Interference Prevention Function

If reflective Photoelectric Sensors are installed side by side, each reflective Photoelectric Sensor may be influenced by the light emitted from the other Photoelectric Sensors.

The fuzzy mutual interference prevention function of the E3S-C enables the E3S-C to monitor any light interference for a certain period before the E3S-C starts emitting light so that the E3S-C can retrieve the intensity and frequency of the light interference as data. Using this data, the E3S-C estimates with fuzzy inference the risk of the malfunctioning of the E3S-C and controls the timing of the E3S-C's light emission.

When the risk is low:
The E3S-C waits until there is no light interference and emits light.



When the risk is high:
The E3S-C emits light between each light interference moment.



■ Sensitivity Adjustment (Reflective Sensors)

| Item | Position A | Position B | Setting |
|-----------------------------|---|---|--|
| Sensing condition | | | --- |
| Sensitivity adjustor | | | |
| Indicators | OFF <input type="checkbox"/> STABILITY (green) <input checked="" type="checkbox"/> ON <input checked="" type="checkbox"/> LIGHT (red) <input checked="" type="checkbox"/> | OFF <input type="checkbox"/> STABILITY (green) <input type="checkbox"/> OFF <input type="checkbox"/> LIGHT (red) <input type="checkbox"/> | OFF <input checked="" type="checkbox"/> STABILITY (green) <input type="checkbox"/> ON <input type="checkbox"/> LIGHT (red) <input type="checkbox"/> |
| Procedure | Locate a sensing object at the sensing distance, set the sensitivity adjustor to the minimum scale position, and gradually increase sensitivity by turning the sensitivity adjustor clockwise until the incident light indicator (red LED) is ON. Position A is where the indicator has turned ON. Regard the maximum scale position as Position A if the indicator does not turn ON at full sensitivity. | Remove the sensing object and turn the sensitivity adjustor clockwise until the E3S-C detects the background object and the incident light indicator (red LED) is lit. The moment the red light indicator is lit, stop turning the sensitivity adjustor, the position of which is point B. Turn the sensitivity adjustor counterclockwise to decrease the sensitivity until the red light indicator is OFF, stop turning the sensitivity adjustor, the position of which is point C. If there is no background object, point C is where the sensitivity adjustor is set to maximum. | Set the sensitivity indicator to the position between Positions A and C (in some cases, Positions A and C are opposite of the above example). The photoelectric sensor will then work normally if the stability indicator (green) is lit with and without the sensing object. If it is not lit, stable operation cannot be expected, in which case a different detection method must be applied. |

Unlike conventional photoelectric sensors, the variation in the sensitivity of E3S photoelectric sensors is minimal. This means the sensitivity can be adjusted on only a single photoelectric sensor, and then the adjustors on the other photoelectric sensors can be set to the same scale position. There is no need to adjust the sensitivity of each photoelectric sensor individually.

Dimensions

Note: All units are in millimeters unless otherwise indicated.

E3S-CT16 E3S-CT16-L (Emitter)

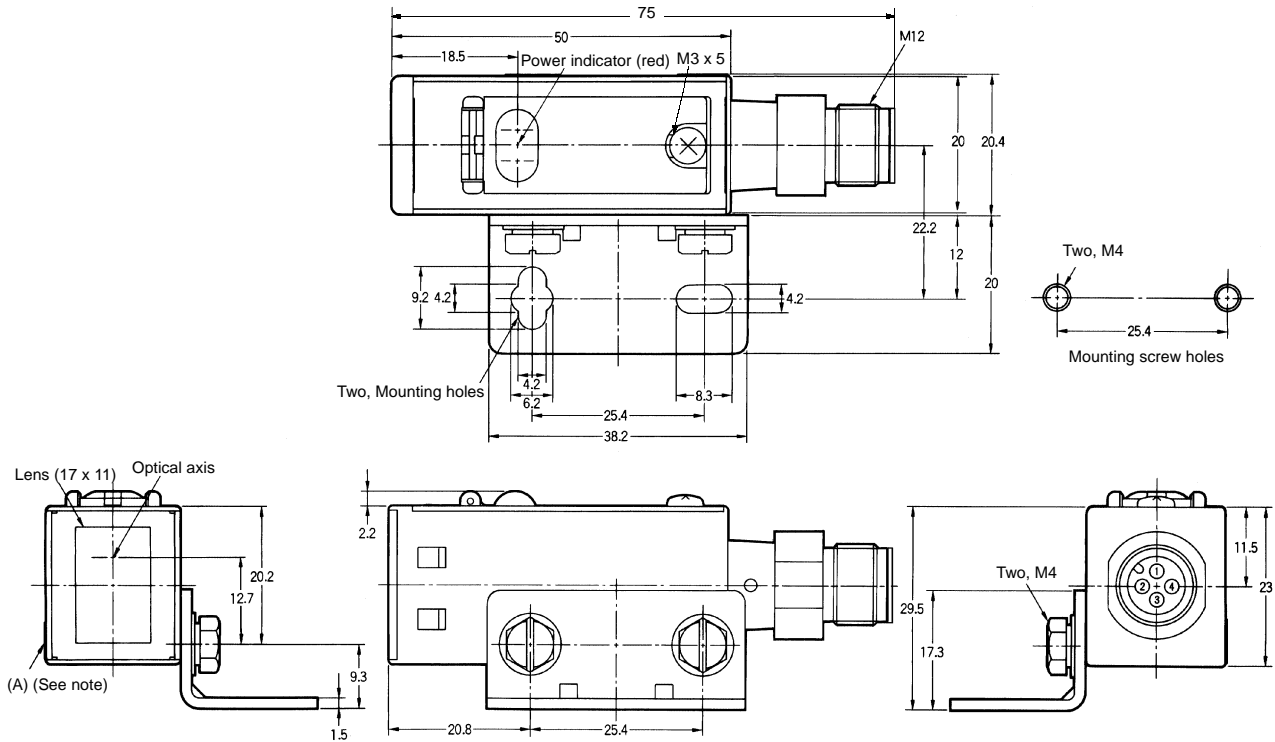

Note: Mounting bracket can be attached to side A.

E3S-CT16-D (Receiver)

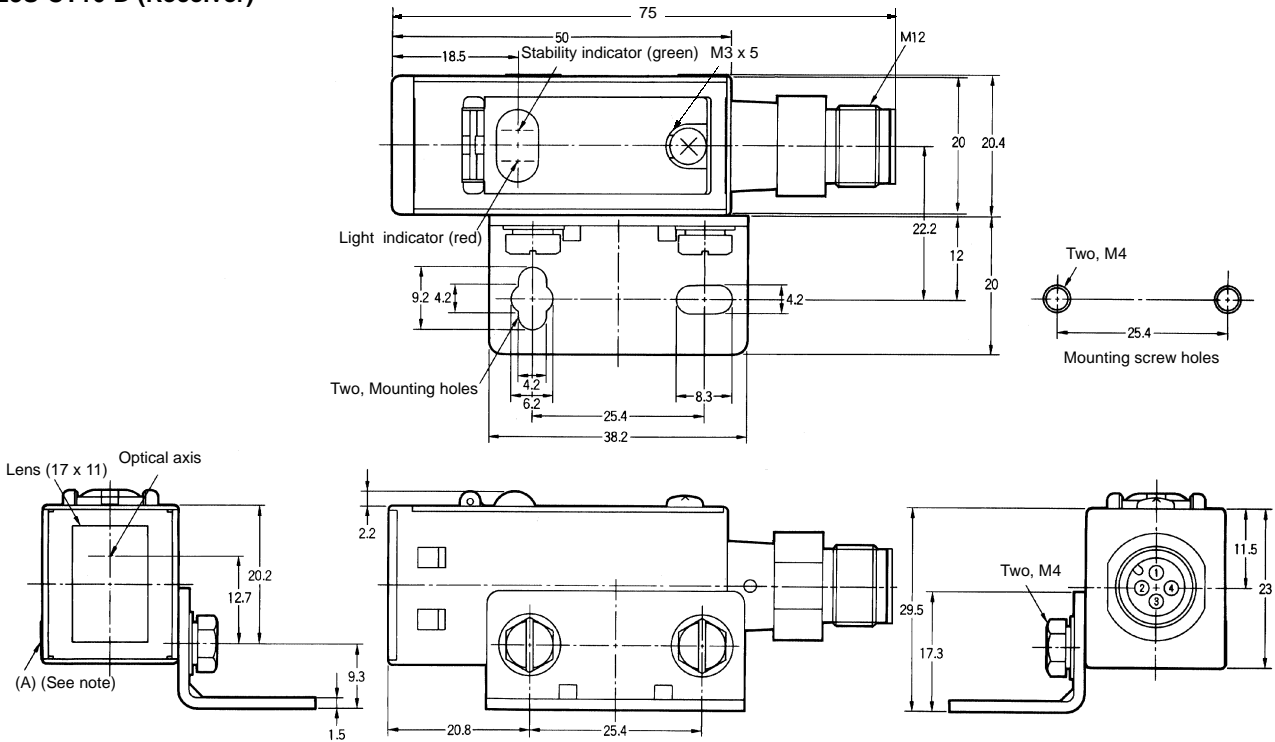

Note: Mounting bracket can be attached to side A.

E3S-CT66
E3S-CT66-L (Emitter)

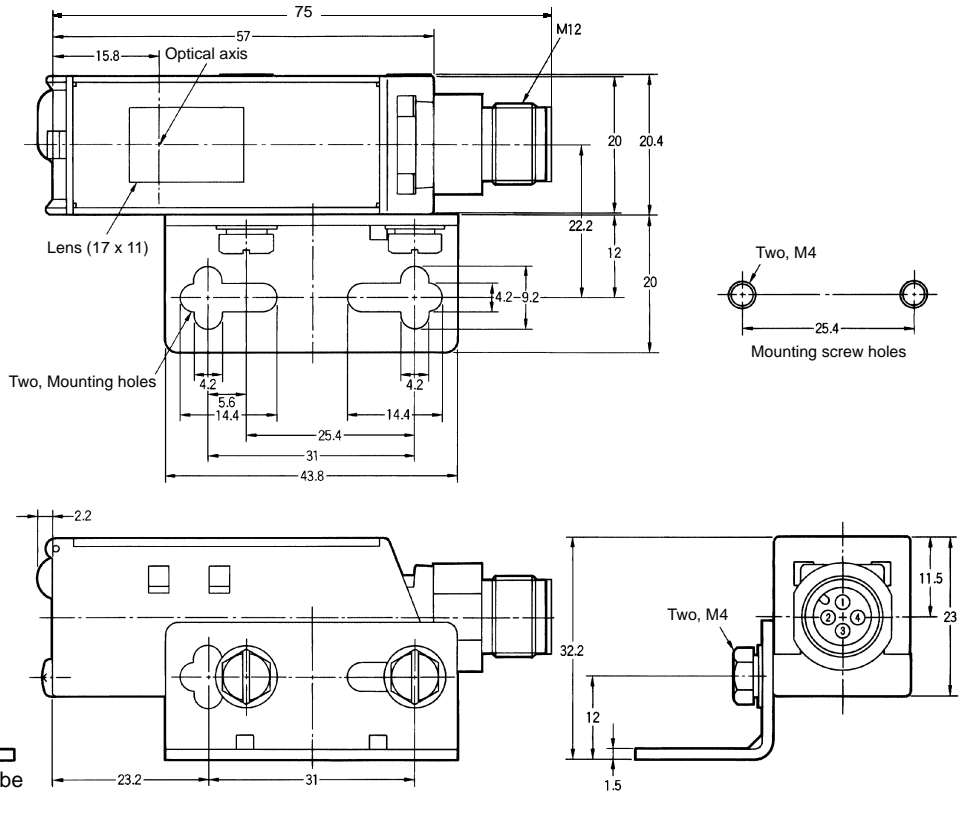

E3S-CT66-D (Receiver)

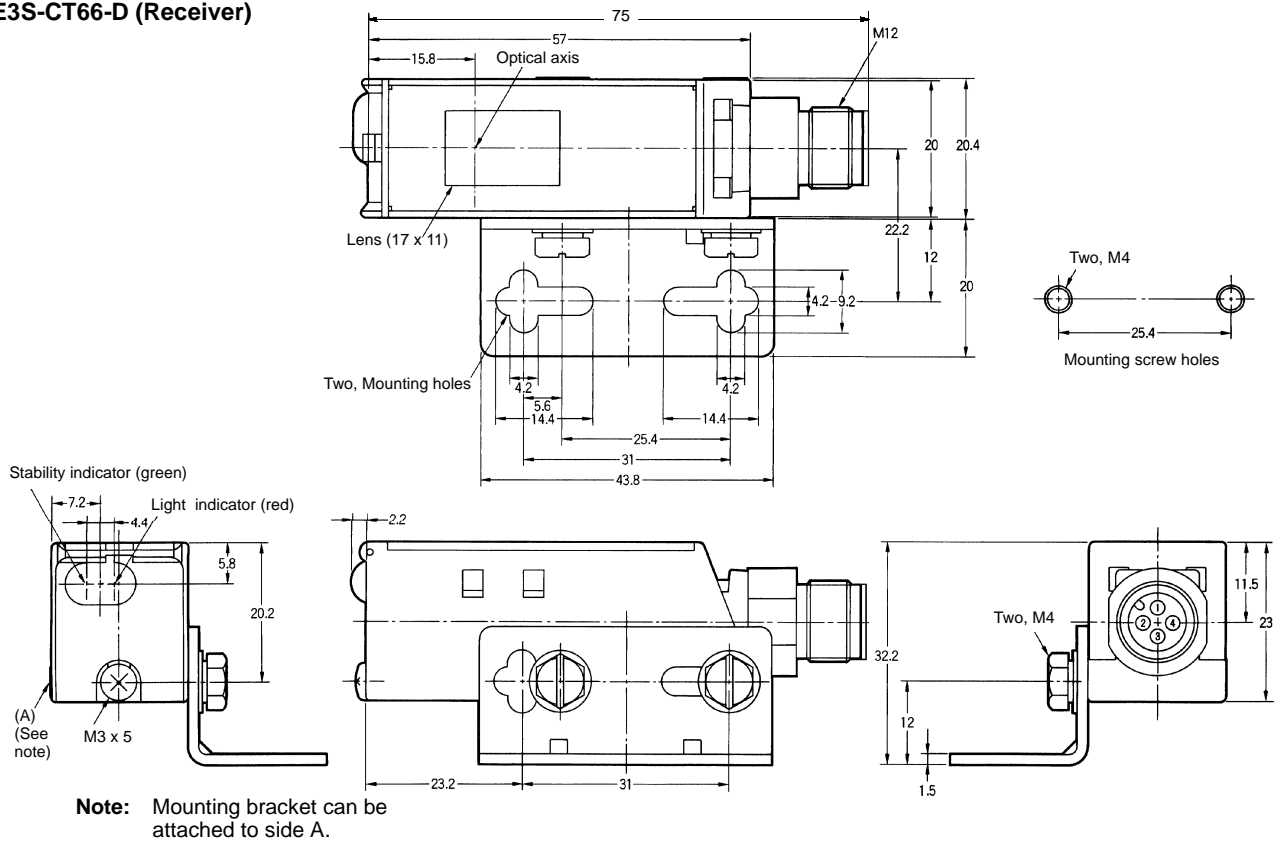

E3S-CR16/-CD16/-CD17

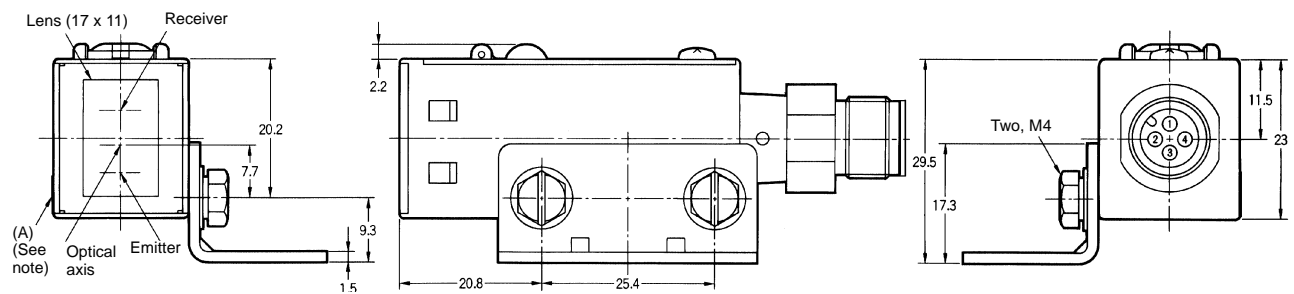
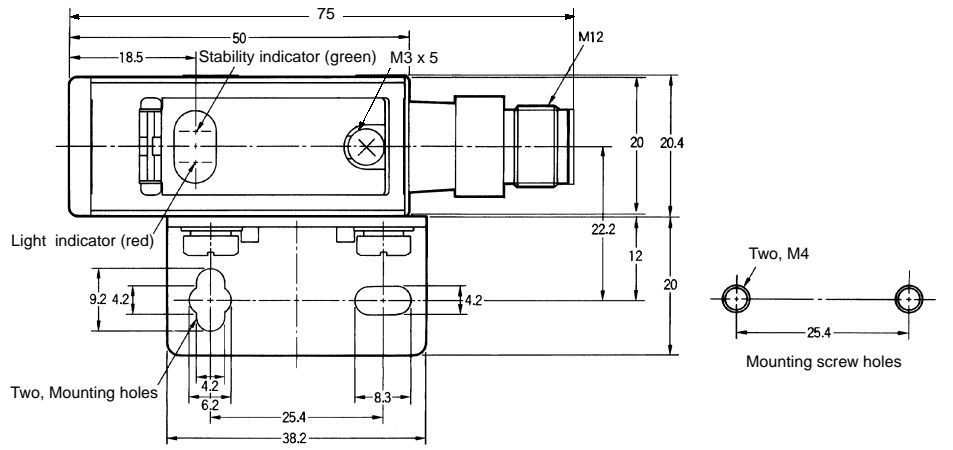

Note: Mounting bracket can be attached to side A.

E3S-CR66/-CD66/-CD67

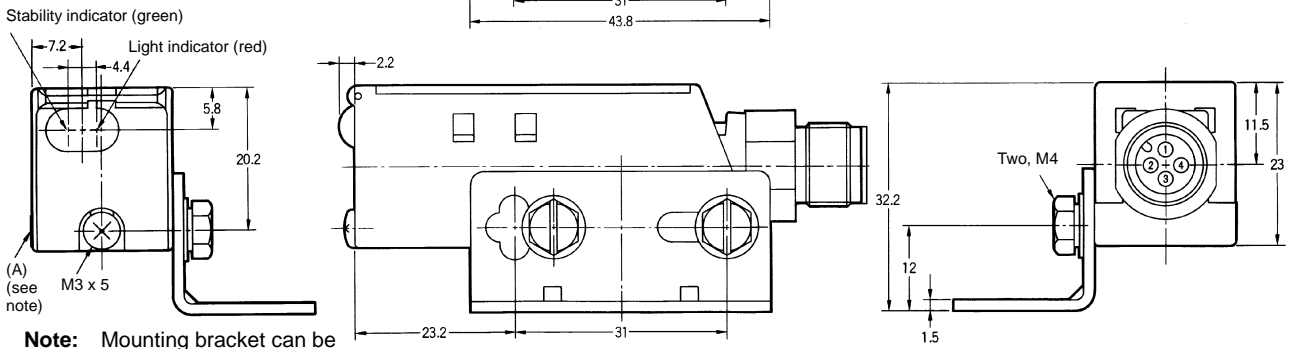
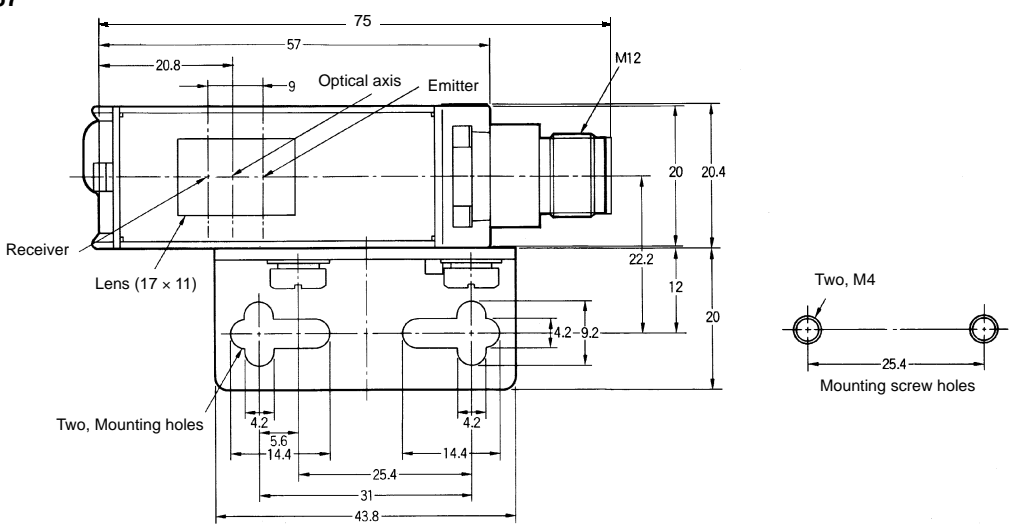

Note: Mounting bracket can be attached to side A.

Attachments

E39-R1 Retroreflector

(Retroreflective type, provided with the E3S-CR16/-CR66)

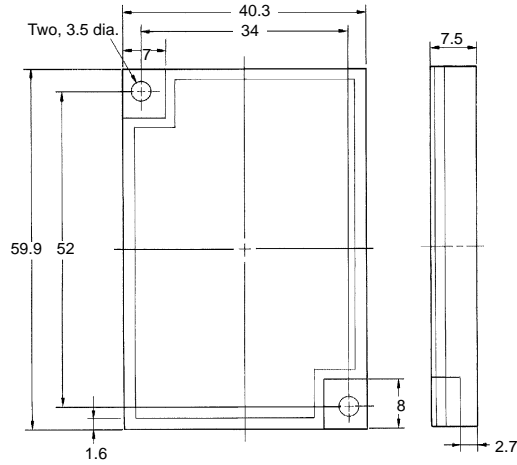
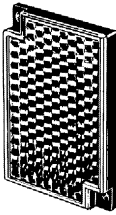

E39-L87 Special Mounting Bracket

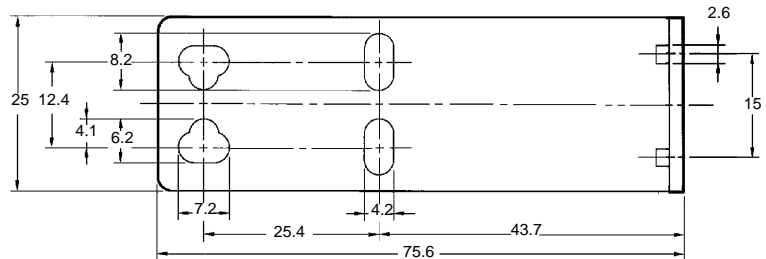
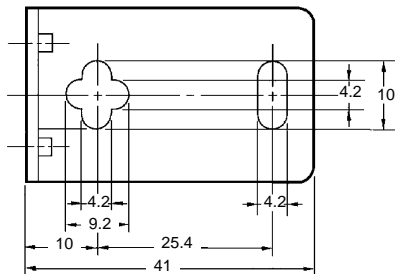
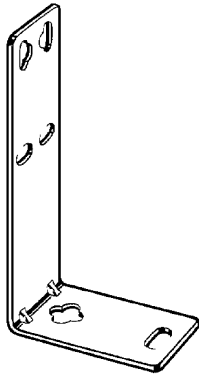

E39-S61 Slit for E3S-C

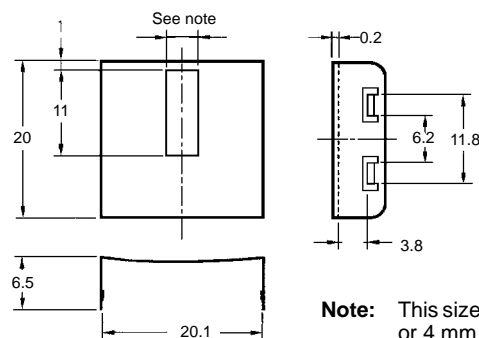
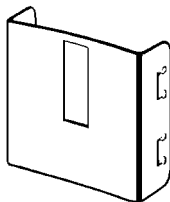

Note: This size is 0.5 mm, 1 mm, 2 mm, or 4 mm depending on the type.

Installation

■ Connections

Load (Relay)

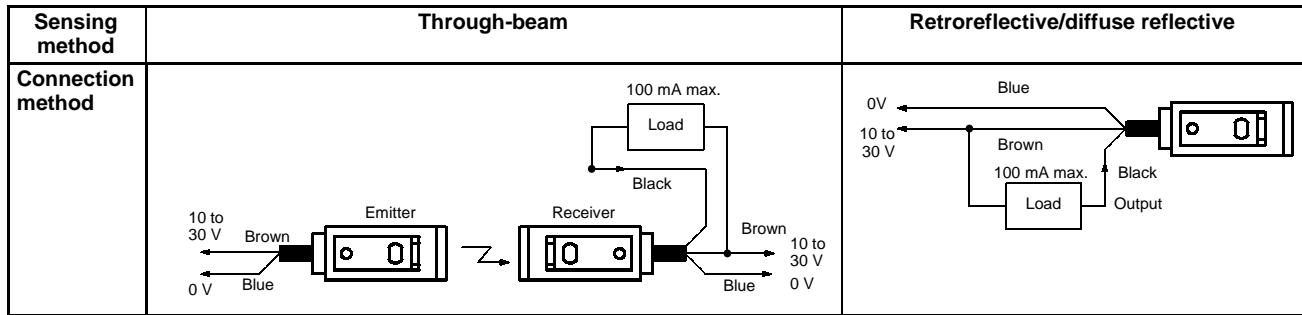

Note: If the load is a relay, insert a surge absorbing diode between the coils of the relay.
The connection examples are for sensors with the NPN output.

With Sensor Controller (S3D2)

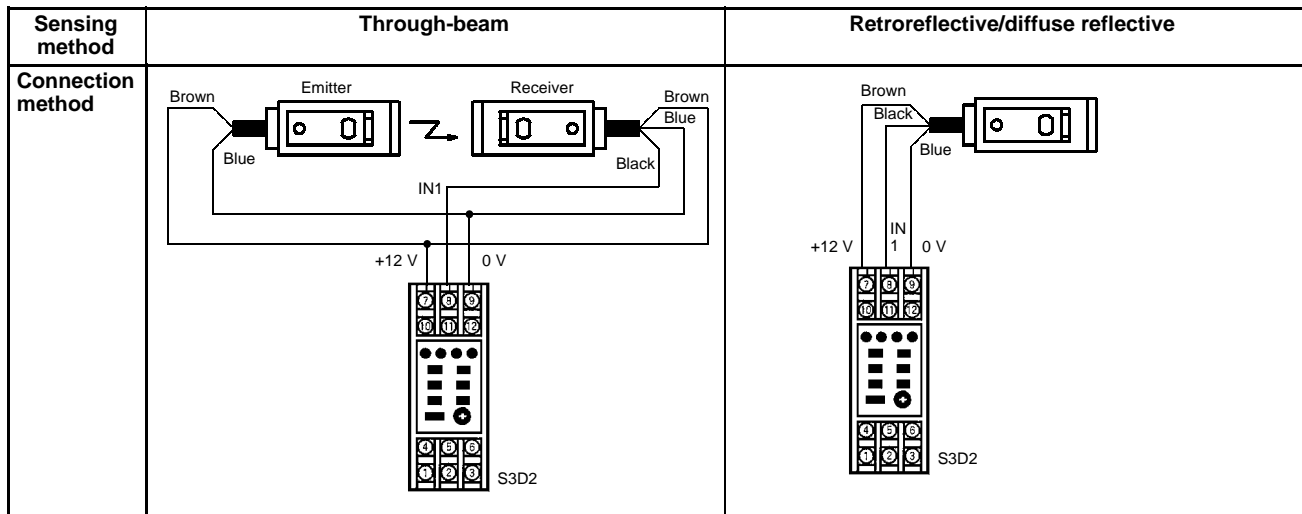

Precautions

Connection

If the input/output lines of the photoelectric sensor are placed in the same conduit or duct as power lines or high-voltage lines, the photoelectric sensor could be induced to malfunction, or even be damaged, by electrical noise. Either separate the wiring, or use shielded lines as input/output lines to the photoelectric sensor.

The cord connected to the E3S-C can be extended up to 100 m provided that the diameter of each wire of the cord is 0.3 mm² minimum.

Startup Operation

A maximum of 100 ms is required from the time power is turned on until the E3S-C is able to detect objects. If power is supplied to the loads and the E3S-C from different sources, turn on power to the E3S-C first.

Oil and Chemical Resistivity

Do not use the E3S-C in oils or liquid chemicals.

Power Supply

If a standard switching regulator is used as a power supply, the frame ground (FG) terminal and the ground (G) terminal must be grounded, or otherwise the E3S-C may malfunction, due to the switching noise of the power supply.

Water Resistivity

Do not use the E3S-C in water, in the rain, or outdoors.

To ensure the water resistivity of the E3S-C, tighten the screws of the operation panel cover to a torque of 3.5 to 5.5 kgf S cm (0.34 N S m to 0.54 N S m).

Cable

The E3S-C uses an oil-resistive cord to ensure oil resistivity.

Do not allow the cable to be repeatedly bent during application.

Do not allow the cable to be bent to a radius of less than 25 mm.

Mounting

When mounting the E3S-C, do not hit the E3S-C with a hammer, or the E3S-C will lose watertightness.

Use M4 screws to mount the E3S-C.

The tightening torque of each screw must be 12 kgf S m (1.18 N S m) maximum.

Mounting Bracket

When mounting the E3S-C with the mounting bracket so that sensing objects will be in the direction of the mechanical axis, use the optical axis lock holes.

If it is not possible to mount the E3S-C so that the sensing objects will be in the direction the mechanical axis, move the E3S-C upwards, downwards, to the left, or to the right and secure the E3S-C in the center of the range where the light indicator will be lit, at which time make sure that the stability indicator is lit.

Direct Mounting

Mount the E3S-C as shown in the following illustration.

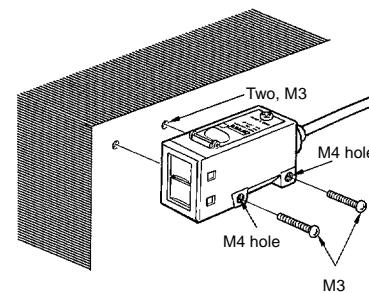
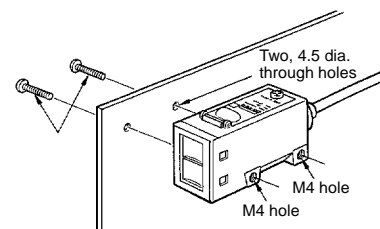

Malfunctioning

If an inverter motor or servomotor is used with the E3S-C, the frame ground (FG) terminal and the ground (G) terminal must be grounded, or otherwise the E3S-C may malfunction.

Optical Axis Adjustment

Direct the mounting axis of the mounting bracket in the direction where sensing objects will be located. The optical axis of the E3S-C coincides with the mounting axis of the mounting bracket, which enables the user to adjust the optical axis of the E3S-C with ease.

Optical Lock Holes

By tightening the optical axis lock holes with screws, the mounting bracket will be in the direction of the optical axis of the E3S-C.

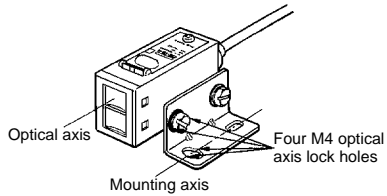

Optical Axis of Through-beam Sensor

The E3S-C through-beam models incorporate two lenses, one of which will be used as shown in the following illustration. When using a slit, the slit must be on the side where the lens to be used is located.

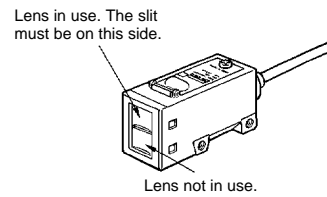

ALL DIMENSIONS SHOWN ARE IN MILLIMETERS.

To convert millimeters into inches, multiply by 0.03937. To convert grams into ounces, multiply by 0.03527.

Cat. No. E247-E1-2A In the interest of product improvement, specifications are subject to change without notice.

OMRON Corporation

Systems Components Division H.Q.
28th Fl., Crystal Tower Bldg.
1-2-27, Shiromi, Chuo-ku,
Osaka 540 Japan
Phone: 06-949-6012 Fax: 06-949-6021

Printed in Japan
0197-2M (1195) a