

# Built-in power supply photoelectric sensor E3JK <NEW>

## All voltage photoelectric sensors with long sensing distance

- High power and visible red LED for all models enabling easy alignment and long sensing distance
- Relay output (all voltage) and transistor output models
- Bright indicator LEDs that are visible at large distance
- Best price-value ratio



## Ordering Information

### Sensors

Red light

Power supply voltage	Sensing method	Appearance	Sensing distance	Output configuration	Model
AC/DC power supply selectable type	Through-beam *1 (Emitter + Receiver)		40 m	Relay	<b>E3JK-TR11 2M</b> Emitter: E3JK-TR11-L 2M Receiver: E3JK-TR11-D 2M
	Retro-reflective without MSR function		9 m [100 mm] (When using E39-R1S) *3		<b>E3JK-RR11 2M</b>
	Retro-reflective with MSR function		*2  7 m [100 mm] (When using E39-R1S) *3		<b>E3JK-RR12 2M</b>
	Diffuse-reflective		2.5 m		<b>E3JK-DR11 2M</b>
			300 mm		<b>E3JK-DR12 2M</b>

# E3JK

Power supply voltage	Sensing method	Appearance	Sensing distance	Output configuration	Model
DC	Through-beam *1 (Emitter + Receiver)		40 m	NPN	<b>E3JK-TN11 2M</b> Emitter: E3JK-TN11-L 2M Receiver: E3JK-TN11-D 2M
				PNP	<b>E3JK-TP11 2M</b> Emitter: E3JK-TP11-L 2M Receiver: E3JK-TP11-D 2M
	Retro-reflective without MSR function		9 m [100 mm] (When using E39-R1S)	*3 NPN	<b>E3JK-RN11 2M</b>
				PNP	<b>E3JK-RP11 2M</b>
	Retro-reflective with MSR function		*2 7 m [100 mm] (When using E39-R1S)	*3 NPN	<b>E3JK-RN12 2M</b>
				PNP	<b>E3JK-RP12 2M</b>
	Diffuse-reflective		2.5 m	NPN	<b>E3JK-DN11 2M</b>
				PNP	<b>E3JK-DP11 2M</b>
				NPN	<b>E3JK-DN12 2M</b>
				PNP	<b>E3JK-DP12 2M</b>

- \*1. Through-beam Sensors are sold in sets that include both the Emitter and Receiver.  
 \*2. A Reflector is not included. Purchase a Reflector separately to match the intended use of the Sensor.  
 \*3. Values in parentheses indicate the minimum required distances between the Sensors and Reflectors.

## Accessories (Order Separately)

**Reflectors** (A Reflector is required for Retro-reflective Sensors.) [Refer to *Dimensions* on page 11.]

A Reflector is not provided with the Sensor. Be sure to order a Reflector separately.

Name	Sensing distance (rated value)		Model	Quantity
Reflectors	E3JK-R□11	7 m [100 mm] *	E39-R1	1
	E3JK-R□12	6 m [100 mm] *		
	E3JK-R□11	9 m [100 mm] *	E39-R1S	1
	E3JK-R□12	7 m [100 mm] *		
	E3JK-R□11	11 m [100 mm] *	E39-R2	1
	E3JK-R□12	10 m [100 mm] *		

Note: Refer to *Engineering Data (Reference Value)* on page 7 for details.  
 \*Values in parentheses indicate the minimum required distances between the Sensors and Reflectors.

**Mounting Bracket** [Refer to *Dimensions* on page 11.]

A Mounting Bracket is not provided with the Sensor. Order a Mounting Bracket separately if required.

Appearance	Model	Quantity
	<b>E39-L40</b>	1

- Note: 1. When using a Through-beam Sensor, order one Mounting Bracket for the Receiver and one for the Emitter.  
 2. For details, refer to *Mounting Brackets* on E39-L/E39-S/E39-R which can be accessed from your OMRON website.

## Ratings and Specifications

Sensing method		Through-beam		
Item	Model	E3JK-TR11	E3JK-TN11	E3JK-TP11
Sensing distance		40 m		
Standard sensing object		Opaque: 17-mm dia. min.		
Differential travel		-		
Directional angle		Both Emitter and Receiver 3° min.		
Light source (wavelength)		Red LED (624 nm)		
Power supply voltage		24 to 240 VDC ±10%, ripple (p-p): 10% max. 24 to 240 VAC ±10%, 50/60 Hz	10 to 30 VDC, including ripple (p-p): 10%	
Power consumption	DC	3 W max. (Emitter 1.5 W max. Receiver 1.5 W max.)	40 mA max. (Emitter 25 mA max. Receiver 15 mA max.)	
	AC	3 W max. (Emitter 1.5 W max. Receiver 1.5 W max.)	-	
Control output		Relay output SPDT, 250 VAC, 3 A max. (cosφ= 1), 5 VDC, 10 mA min., Light-ON/Dark-ON selectable	Load power supply voltage: 30 V max., Load current: 100 mA max., Residual voltage: 3 V max., open-collector output (NPN/PNP output depending on model), Light-ON/Dark-ON selectable	
Life expectancy (relay output)	Mechanical	50,000,000 times min. (switching frequency: 18,000 times/h)		
	Electrical	100,000 times min. (switching frequency: 1,800 times/h)		
Response time		20 ms max.	1 ms max.	
Sensitivity adjustment		One-turn adjuster Receiver (E3JK-T□□□-D) only		
Ambient illumination (Receiver side)		Incandescent lamp: 3,000 lx max., Sunlight: 11,000 lx max.		
Ambient temperature range		Operating: -25°C to 55°C, Storage: -40°C to 70°C (with no icing or condensation)		
Ambient humidity range		Operating: 35% to 85%, Storage: 35% to 95% (with no condensation)		
Insulation resistance		20 MΩ min. at 500 VDC		
Dielectric strength		1,500 VAC, 50/60 Hz for 1 minute		
Vibration resistance	Destruction	10 to 55 Hz with a 1.5-mm double amplitude for 2 hours each in X, Y, and Z directions		
	Malfunction	10 to 55 Hz with a 1.5-mm double amplitude for 2 hours each in X, Y, and Z directions		
Shock resistance	Destruction	500 m/s <sup>2</sup> for 3 times each in X, Y, and Z directions		
	Malfunction	100 m/s <sup>2</sup> for 3 times each in X, Y, and Z directions	500 m/s <sup>2</sup> for 3 times each in X, Y, and Z directions	
Degree of protection		IEC 60529 IP64		
Connection method		Pre-wired (standard length: 2 m)		
Weight (packed state)		Approx. 350 g	Approx. 300 g	
Material	Case	ABS (Acrylonitril Butadiene Styrene)		
	Lens/ Display window	Methacrylic resin		
	Adjuster	POM		
Accessories		Instruction manual		

# E3JK

Sensing method		Retro-reflective (without MSR function)		
Item	Model	E3JK-RR11	E3JK-RN11	E3JK-RP11
Sensing distance		9 m [100 mm] * (When using E39-R1S)		
Standard sensing object		Opaque: 75-mm dia. min.		
Differential travel		-		
Directional angle		1.5° min.		
Light source (wavelength)		Red LED (624 nm)		
Power supply voltage		24 to 240 VDC ±10%, ripple (p-p): 10% max. 24 to 240 VAC ±10%, 50/60 Hz	10 to 30 VDC, including ripple (p-p): 10%	
Power consumption	DC	2 W max.	30 mA max.	
	AC	2 W max.	-	
Control output		Relay output SPDT, 250 VAC, 3 A max. (cosφ= 1), 5 VDC, 10 mA min., Light-ON/Dark-ON selectable	Load power supply voltage: 30 V max., Load current: 100 mA max., Residual voltage: 3 V max., open-collector output (NPN/PNP output depending on model), Light-ON/Dark-ON selectable	
Life expectancy (relay output)	Mechanical	50,000,000 times min. (switching frequency: 18,000 times/h)		
	Electrical	100,000 times min. (switching frequency: 1,800 times/h)		
Response time		20 ms max.	1 ms max.	
Sensitivity adjustment		One-turn adjuster		
Ambient illumination (Receiver side)		Incandescent lamp: 3,000 lx max., Sunlight: 11,000 lx max.		
Ambient temperature range		Operating: -25°C to 55°C, Storage: -40°C to 70°C (with no icing or condensation)		
Ambient humidity range		Operating: 35% to 85%, Storage: 35% to 95% (with no condensation)		
Insulation resistance		20 MΩ min. at 500 VDC		
Dielectric strength		1,500 VAC, 50/60 Hz for 1 minute		
Vibration resistance	Destruction	10 to 55 Hz with a 1.5-mm double amplitude for 2 hours each in X, Y, and Z directions		
	Malfunction	10 to 55 Hz with a 1.5-mm double amplitude for 2 hours each in X, Y, and Z directions		
Shock resistance	Destruction	500 m/s <sup>2</sup> for 3 times each in X, Y, and Z directions		
	Malfunction	100 m/s <sup>2</sup> for 3 times each in X, Y, and Z directions	500 m/s <sup>2</sup> for 3 times each in X, Y, and Z directions	
Degree of protection		IEC 60529 IP64		
Connection method		Pre-wired (standard length: 2 m)		
Weight (packed state)		Approx. 180 g	Approx. 160 g	
Material	Case	ABS (Acrylonitril Butadiene Styrene)		
	Lens/ Display window	Methacrylic resin		
	Adjuster	POM		
Accessories		Instruction manual		

\*Values in parentheses indicate the minimum required distances between the Sensors and Reflectors.

Sensing method		Retro-reflective (with MSR function)		
Item	Model	E3JK-RR12	E3JK-RN12	E3JK-RP12
Sensing distance		7 m [100 mm] * (When using E39-R1S)		
Standard sensing object		Opaque: 75-mm dia. min.		
Differential travel		-		
Directional angle		1.5° min.		
Light source (wavelength)		Red LED (624 nm)		
Power supply voltage		24 to 240 VDC ±10%, ripple (p-p): 10% max. 24 to 240 VAC ±10%, 50/60 Hz	10 to 30 VDC, including ripple (p-p): 10%	
Power consumption	DC	2 W max.	30 mA max.	
	AC	2 W max.	-	
Control output		Relay output SPDT, 250 VAC, 3 A max. (cosφ= 1), 5 VDC, 10 mA min., Light-ON/Dark-ON selectable	Load power supply voltage: 30 V max., Load current: 100 mA max., Residual voltage: 3 V max., open-collector output (NPN/PNP output depending on model), Light-ON/Dark-ON selectable	
Life expectancy (relay output)	Mechanical	50,000,000 times min. (switching frequency: 18,000 times/h)		
	Electrical	100,000 times min. (switching frequency: 1,800 times/h)		
Response time		20 ms max.	1 ms max.	
Sensitivity adjustment		One-turn adjuster		
Ambient illumination (Receiver side)		Incandescent lamp: 3,000 lx max., Sunlight: 11,000 lx max.		
Ambient temperature range		Operating: -25°C to 55°C, Storage: -40°C to 70°C (with no icing or condensation)		
Ambient humidity range		Operating: 35% to 85%, Storage: 35% to 95% (with no condensation)		
Insulation resistance		20 MΩ min. at 500 VDC		
Dielectric strength		1,500 VAC, 50/60 Hz for 1 minute		
Vibration resistance	Destruction	10 to 55 Hz with a 1.5-mm double amplitude for 2 hours each in X, Y, and Z directions		
	Malfunction	10 to 55 Hz with a 1.5-mm double amplitude for 2 hours each in X, Y, and Z directions		
Shock resistance	Destruction	500 m/s <sup>2</sup> for 3 times each in X, Y, and Z directions		
	Malfunction	100 m/s <sup>2</sup> for 3 times each in X, Y, and Z directions	500 m/s <sup>2</sup> for 3 times each in X, Y, and Z directions	
Degree of protection		IEC 60529 IP64		
Connection method		Pre-wired (standard length: 2 m)		
Weight (packed state)		Approx. 180 g	Approx. 160 g	
Material	Case	ABS (Acrylonitril Butadiene Styrene)		
	Lens/ Display window	Methacrylic resin		
	Adjuster	POM		
Accessories		Instruction manual		

\*Values in parentheses indicate the minimum required distances between the Sensors and Reflectors.

# E3JK

Sensing method		Diffuse-reflective					
Item	Model	E3JK-DR11	E3JK-DR12	E3JK-DN11	E3JK-DP11	E3JK-DN12	E3JK-DP12
Sensing distance		White paper (300 × 300 mm): 2.5 m	White paper (100 × 100 mm): 300 mm	White paper (300 × 300 mm): 2.5 m		White paper (100 × 100 mm): 300 mm	
Standard sensing object		-					
Differential travel		20% max. of sensing distance					
Directional angle		-					
Light source (wavelength)		Red LED (624 nm)					
Power supply voltage		24 to 240 VDC ±10%, ripple (p-p): 10% max. 24 to 240 VAC ±10%, 50/60 Hz		10 to 30 VDC, including ripple (p-p): 10%			
Power consumption	DC	2 W max.		30 mA max.			
	AC	2 W max.		-			
Control output		Relay output SPDT, 250 VAC, 3 A max. (cosφ= 1), 5 VDC, 10 mA min., Light-ON/Dark-ON selectable		Load power supply voltage: 30 V max., Load current: 100 mA max., Residual voltage: 3 V max., open-collector output (NPN/PNP output depending on model), Light-ON/Dark-ON selectable			
Life expectancy (relay output)	Mechanical	50,000,000 times min. (switching frequency: 18,000 times/h)					
	Electrical	100,000 times min. (switching frequency: 1,800 times/h)					
Response time		20 ms max.		1 ms max.			
Sensitivity adjustment		One-turn adjuster					
Ambient illumination (Receiver side)		Incandescent lamp: 3,000 lx max., Sunlight: 11,000 lx max.					
Ambient temperature range		Operating: -25°C to 55°C, Storage: -40°C to 70°C (with no icing or condensation)					
Ambient humidity range		Operating: 35% to 85%, Storage: 35% to 95% (with no condensation)					
Insulation resistance		20 MΩ min. at 500 VDC					
Dielectric strength		1,500 VAC, 50/60 Hz for 1 minute					
Vibration resistance	Destruction	10 to 55 Hz with a 1.5-mm double amplitude for 2 hours each in X, Y, and Z directions					
	Malfunction	10 to 55 Hz with a 1.5-mm double amplitude for 2 hours each in X, Y, and Z directions					
Shock resistance	Destruction	500 m/s <sup>2</sup> for 3 times each in X, Y, and Z directions					
	Malfunction	100 m/s <sup>2</sup> for 3 times each in X, Y, and Z directions		500 m/s <sup>2</sup> for 3 times each in X, Y, and Z directions			
Degree of protection		IEC 60529 IP64					
Connection method		Pre-wired (standard length: 2 m)					
Weight (packed state)		Approx. 180 g		Approx. 160 g			
Material	Case	ABS (Acrylonitril Butadiene Styrene)					
	Lens/ Display window	Methacrylic resin					
	Adjuster	POM					
Accessories		Instruction manual					

Engineering Data (Reference Value)

Parallel Operating Range

Through-beam

E3JK-T□□11

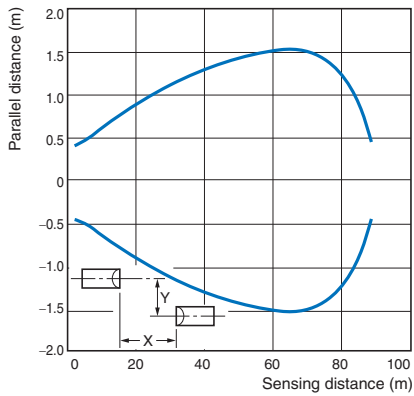

Retro-reflective

E3JK-R□□1+E39-R1

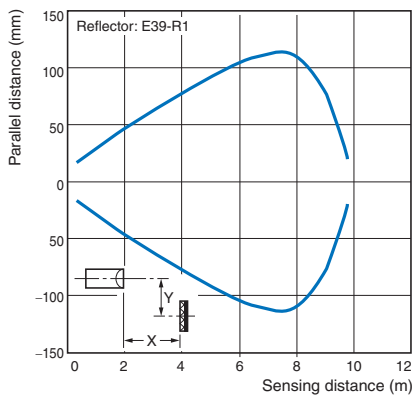

E3JK-R□□1+E39-R1S

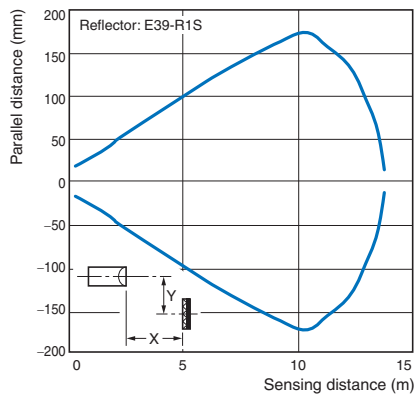

E3JK-R□□1+E39-R2

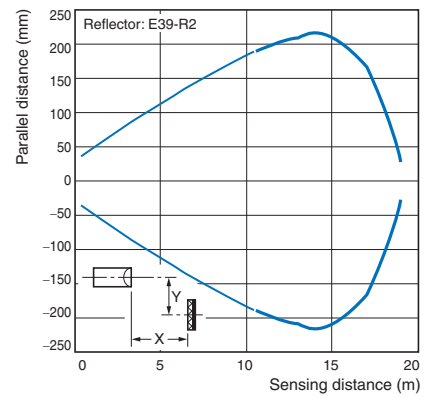

E3JK-R□□2+E39-R1

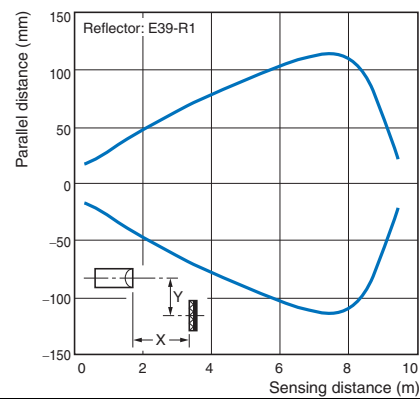

E3JK-R□□2+E39-R1S

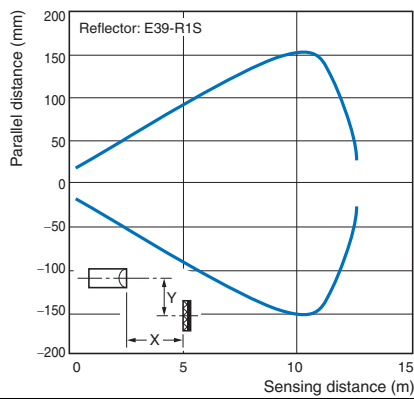

E3JK-R□□2+E39-R2

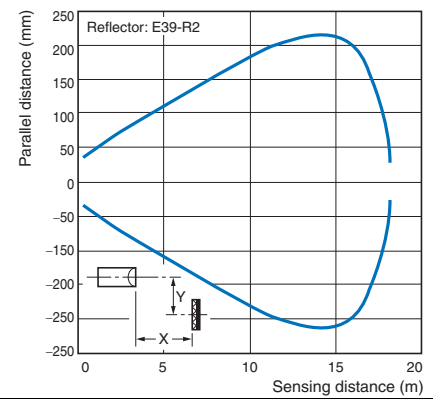

Operating Range

Diffuse-reflective

E3JK-D□□1

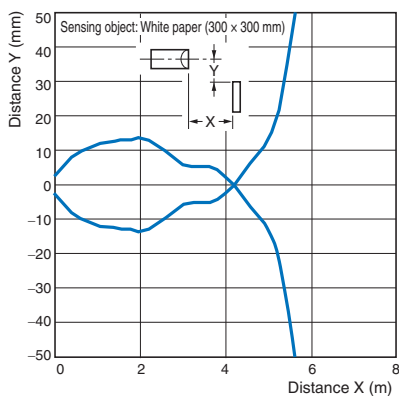

E3JK-D□□2

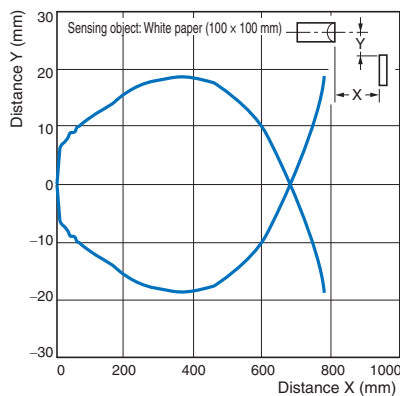

# E3JK

## Excess Gain Ratio vs. Set Distance

### Through-beam

#### E3JK-T□□11

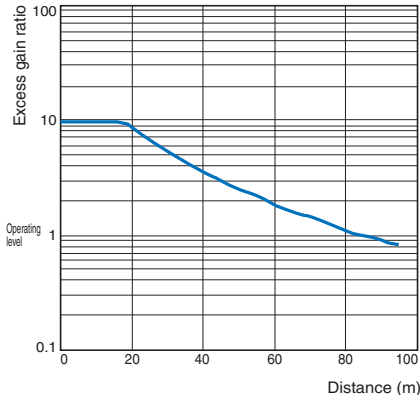

### Retro-reflective

#### E3JK-R□□□1+E39-R1

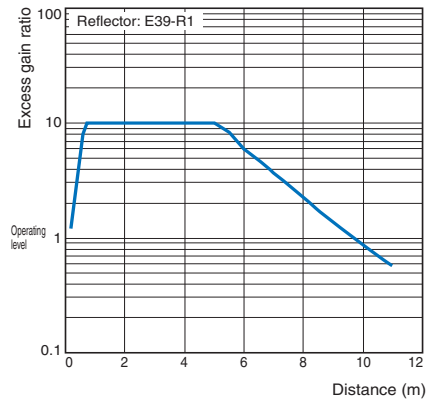

#### E3JK-R□□□1+E39-R1S

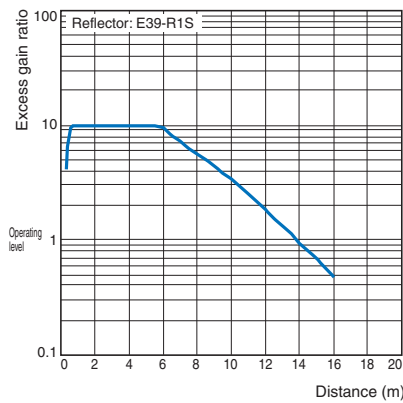

#### E3JK-R□□□1+E39-R2

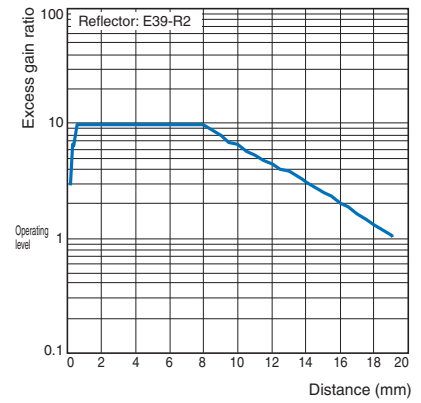

#### E3JK-R□□□2+E39-R1

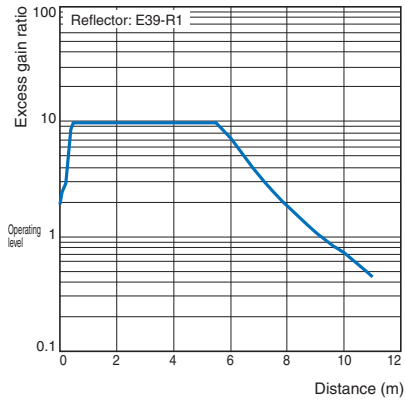

#### E3JK-R□□□2+E39-R1S

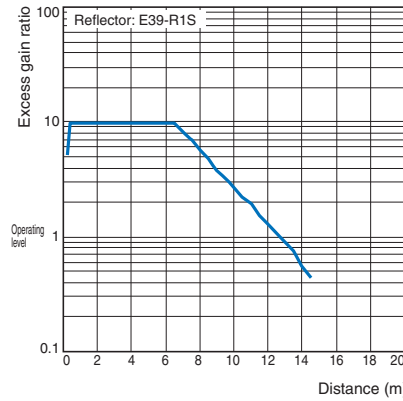

#### E3JK-R□□□2+E39-R2

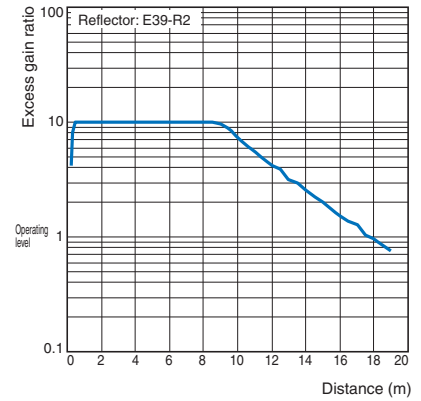

### Diffuse-reflective

#### E3JK-D□□□1

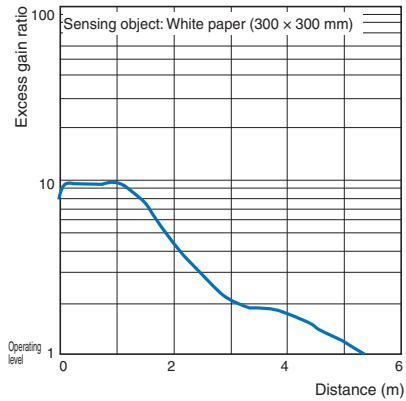

#### E3JK-D□□□2

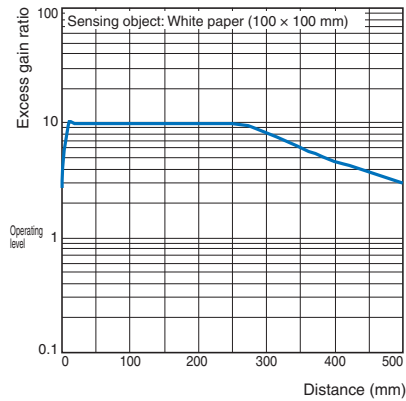



## I/O Circuit Diagrams

### Relay Output Models

Model	Timing chart		Output circuit
	Light-ON	Dark-ON	
E3JK-TR11-L *	/		
E3JK-TR11-D * E3JK-RR11 E3JK-RR12 E3JK-DR11 E3JK-DR12			

### DC SSR Output Models

Model	Timing chart		Output circuit
	Light-ON	Dark-ON	
E3JK-TN11-L * E3JK-TP11-L *	/		
E3JK-TN11-D * E3JK-RN11 E3JK-RN12 E3JK-DN11 E3JK-DN12			
E3JK-TP11-D * E3JK-RP11 E3JK-RP12 E3JK-DP11 E3JK-DP12			

**Note:** Connect the brown cable to any polarity and the blue cable to the power supply because there is no polarity on the Emitter side.

\*For the Through-beam Sensor, the Emitter is listed as E3JK-T□11-L and the Receiver is listed as E3JK-T□11-D in the table.

Confirm the models to order in "Ordering Information."

# E3JK

## Safety Precautions

---

Refer to *Warranty and Limitations of Liability*.

### **WARNING**

This product is not designed or rated for ensuring safety of persons either directly or indirectly.

Do not use it for such purposes.



### **Caution**

Do not wire the product incorrectly.

Do not use this product with a damaged case or cable.



Do not disassemble, repair, or modify this product.

Doing so may lead to explosion, fire, or product failure.



### **Precautions for Safe Use**

The following precautions must be observed to ensure safe operation of the Sensor.

1. Do not use the Sensor in environments subject to flammable, explosive or corrosive gases.
2. Do not use this product in an environment in which oil or chemicals are present.
3. Do not use this product under water, in the rain, or outdoors.
4. Do not use this product under conditions that exceed or in an environment that exceeds the ratings.
5. When using an AC power supply, do not use a power supply that includes high frequencies (such as an inverter).
6. Do not use this product in a location subject to direct sunlight.
7. Do not use this product in a location in which the product will be subject to direct vibrations or impacts.
8. Do not use thinner, alcohol, or other organic solvents with this product.
9. When disposing of the Sensor, treat it as industrial waste.

### **Precautions for Correct Use**

- If the product is wired to high-voltage power lines and power lines in the same pipe or the same duct, the product may malfunction or be damaged due to induction. Therefore, in principle, perform these two types of wiring separately or use shielded cords.
- Do not apply excessive force to the cables.
- When using a commercially available switching regulator, be sure to install an FG (frame ground terminal).
- The time between the product being turned ON and sensing being possible is 100 ms, so wait at least 100 ms after turning the product ON before using it. If the load and the product are connected to different power supplies, be sure to turn the product ON first.
- An output pulse may be generated when the product is turned OFF, so we recommend turning the load or the load line OFF first.

**Dimensions**

Tolerance class IT16 applies to dimensions in this datasheet unless otherwise specified.

**Sensors**

**Through-beam**  
**E3JK-T□11**



**<Emitter>**  
**E3JK-T□11-L**

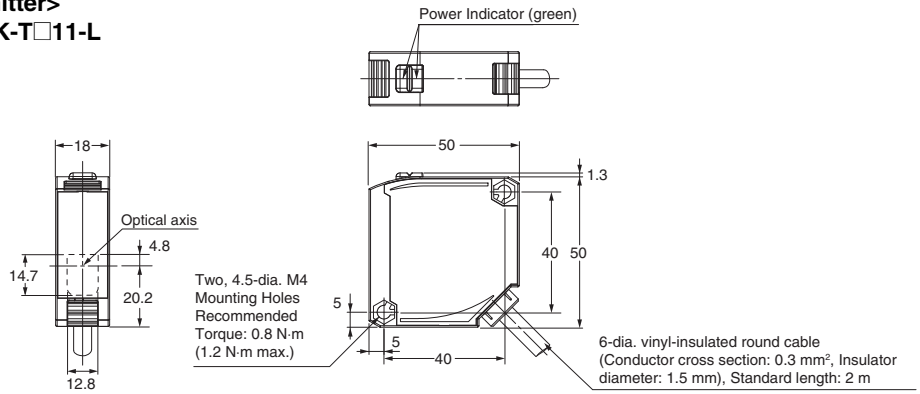

**<Receiver>**  
**E3JK-T□11-D**

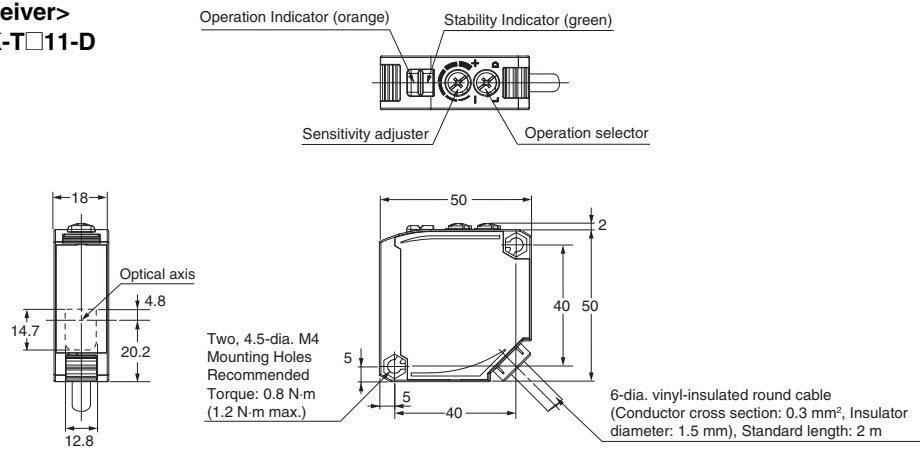

**Diffuse-reflective/**  
**Retro-reflective**

**E3JK-R□1□**  
**E3JK-D□1□**

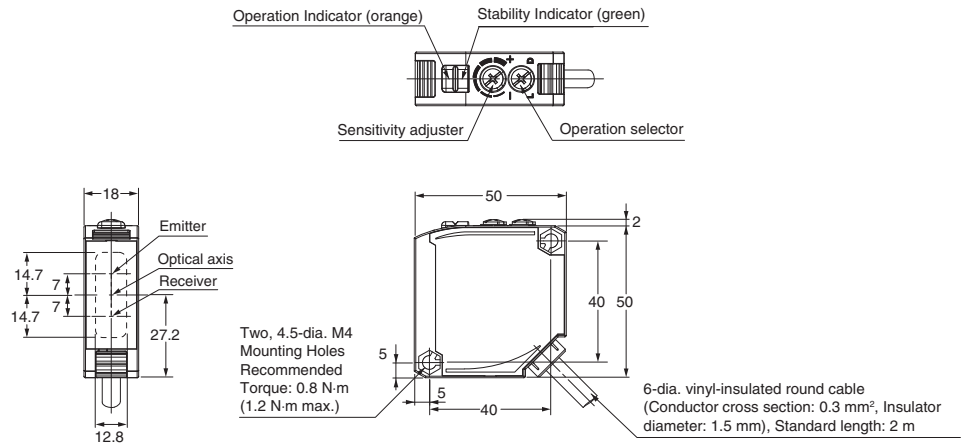



## Read and Understand This Catalog

Please read and understand this catalog before purchasing the products. Please consult your OMRON representative if you have any questions or comments.

## Warranty and Limitations of Liability

### WARRANTY

OMRON's exclusive warranty is that the products are free from defects in materials and workmanship for a period of one year (or other period if specified) from date of sale by OMRON.

OMRON MAKES NO WARRANTY OR REPRESENTATION, EXPRESS OR IMPLIED, REGARDING NON-INFRINGEMENT, MERCHANTABILITY, OR FITNESS FOR PARTICULAR PURPOSE OF THE PRODUCTS. ANY BUYER OR USER ACKNOWLEDGES THAT THE BUYER OR USER ALONE HAS DETERMINED THAT THE PRODUCTS WILL SUITABLY MEET THE REQUIREMENTS OF THEIR INTENDED USE. OMRON DISCLAIMS ALL OTHER WARRANTIES, EXPRESS OR IMPLIED.

### LIMITATIONS OF LIABILITY

OMRON SHALL NOT BE RESPONSIBLE FOR SPECIAL, INDIRECT, OR CONSEQUENTIAL DAMAGES, LOSS OF PROFITS OR COMMERCIAL LOSS IN ANY WAY CONNECTED WITH THE PRODUCTS, WHETHER SUCH CLAIM IS BASED ON CONTRACT, WARRANTY, NEGLIGENCE, OR STRICT LIABILITY.

In no event shall the responsibility of OMRON for any act exceed the individual price of the product on which liability is asserted.

IN NO EVENT SHALL OMRON BE RESPONSIBLE FOR WARRANTY, REPAIR, OR OTHER CLAIMS REGARDING THE PRODUCTS UNLESS OMRON'S ANALYSIS CONFIRMS THAT THE PRODUCTS WERE PROPERLY HANDLED, STORED, INSTALLED, AND MAINTAINED AND NOT SUBJECT TO CONTAMINATION, ABUSE, MISUSE, OR INAPPROPRIATE MODIFICATION OR REPAIR.

## Application Considerations

### SUITABILITY FOR USE

OMRON shall not be responsible for conformity with any standards, codes, or regulations that apply to the combination of products in the customer's application or use of the products.

At the customer's request, OMRON will provide applicable third party certification documents identifying ratings and limitations of use that apply to the products. This information by itself is not sufficient for a complete determination of the suitability of the products in combination with the end product, machine, system, or other application or use.

The following are some examples of applications for which particular attention must be given. This is not intended to be an exhaustive list of all possible uses of the products, nor is it intended to imply that the uses listed may be suitable for the products:

- Outdoor use, uses involving potential chemical contamination or electrical interference, or conditions or uses not described in this catalog.
- Nuclear energy control systems, combustion systems, railroad systems, aviation systems, medical equipment, amusement machines, vehicles, safety equipment, and installations subject to separate industry or government regulations.
- Systems, machines, and equipment that could present a risk to life or property.

Please know and observe all prohibitions of use applicable to the products.

NEVER USE THE PRODUCTS FOR AN APPLICATION INVOLVING SERIOUS RISK TO LIFE OR PROPERTY WITHOUT ENSURING THAT THE SYSTEM AS A WHOLE HAS BEEN DESIGNED TO ADDRESS THE RISKS, AND THAT THE OMRON PRODUCTS ARE PROPERLY RATED AND INSTALLED FOR THE INTENDED USE WITHIN THE OVERALL EQUIPMENT OR SYSTEM.

### PROGRAMMABLE PRODUCTS

OMRON shall not be responsible for the user's programming of a programmable product, or any consequence thereof.

## Disclaimers

### CHANGE IN SPECIFICATIONS

Product specifications and accessories may be changed at any time based on improvements and other reasons.

It is our practice to change model numbers when published ratings or features are changed, or when significant construction changes are made. However, some specifications of the products may be changed without any notice. When in doubt, special model numbers may be assigned to fix or establish key specifications for your application on your request. Please consult with your OMRON representative at any time to confirm actual specifications of purchased products.

### DIMENSIONS AND WEIGHTS

Dimensions and weights are nominal and are not to be used for manufacturing purposes, even when tolerances are shown.

### PERFORMANCE DATA

Performance data given in this catalog is provided as a guide for the user in determining suitability and does not constitute a warranty. It may represent the result of OMRON's test conditions, and the users must correlate it to actual application requirements. Actual performance is subject to the OMRON Warranty and Limitations of Liability.

### ERRORS AND OMISSIONS

The information in this document has been carefully checked and is believed to be accurate; however, no responsibility is assumed for clerical, typographical, or proofreading errors, or omissions.

This document provides information mainly for selecting suitable models. Please read the Instruction sheet carefully for information that the user must understand and accept before purchase, including information on warranty, limitations of liability, and precautions.

**OMRON Corporation Industrial Automation Company**

Tokyo, JAPAN

Contact: [www.ia.omron.com](http://www.ia.omron.com)

**Regional Headquarters**

**OMRON EUROPE B.V.**

**Sensor Business Unit**

Carl-Benz-Str. 4, D-71154 Nufringen,  
Germany

Tel: (49) 7032-811-0/Fax: (49) 7032-811-199

**OMRON ASIA PACIFIC PTE. LTD.**

No. 438A Alexandra Road # 05-05/08 (Lobby 2),  
Alexandra Technopark,  
Singapore 119967

Tel: (65) 6835-3011/Fax: (65) 6835-2711

**OMRON ELECTRONICS LLC**

One Commerce Drive Schaumburg,  
IL 60173-5302 U.S.A.

Tel: (1) 847-843-7900/Fax: (1) 847-843-7787

**OMRON (CHINA) CO., LTD.**

CRoom 2211, Bank of China Tower,  
200 Yin Cheng Zhong Road,  
PuDong New Area, Shanghai, 200120, China

Tel: (86) 21-5037-2222/Fax: (86) 21-5037-2200

**Authorized Distributor:**

© OMRON Corporation 2013 All Rights Reserved.  
In the interest of product improvement,  
specifications are subject to change without notice.

**Cat. No. E432-E2-01A**

0313(0313)