

Marking Accessories - Description and Handling -

WMB Multi marking system

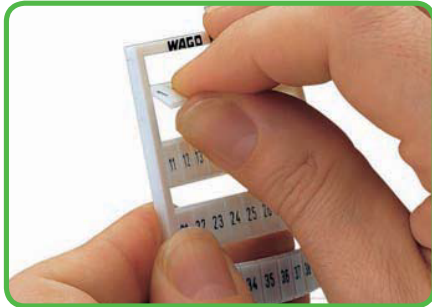

Separating a strip from the WMB or WMB marker card.



Stretching a strip.



Separating an individual marker from the strip, for larger terminal blocks.

Miniature WSB (WAGO Quick marking system)



Marking with miniature WSB Quick marking system.

Miniature WSB or WMB marking

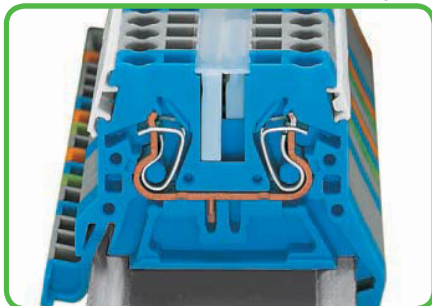

WMB markers in miniature WSB marker receptacles
Marking strips, translucent
Miniature WSB markers



WFB (WAGO continuous marking strips)



Customized ink pen marking



Carrier for WFB Continuous marking strip; to be secured every 10th terminal block.

Group marking



Group marking on N-busbar carrier used as end stop every 10th terminal block.

WMB Multi marking system



Snapping a strip into the marker slot.

Double marker carrier



Snapping a strip into the marker slot of the double marker carrier.

"Decade" marking



WMB "decade" marking carrier.

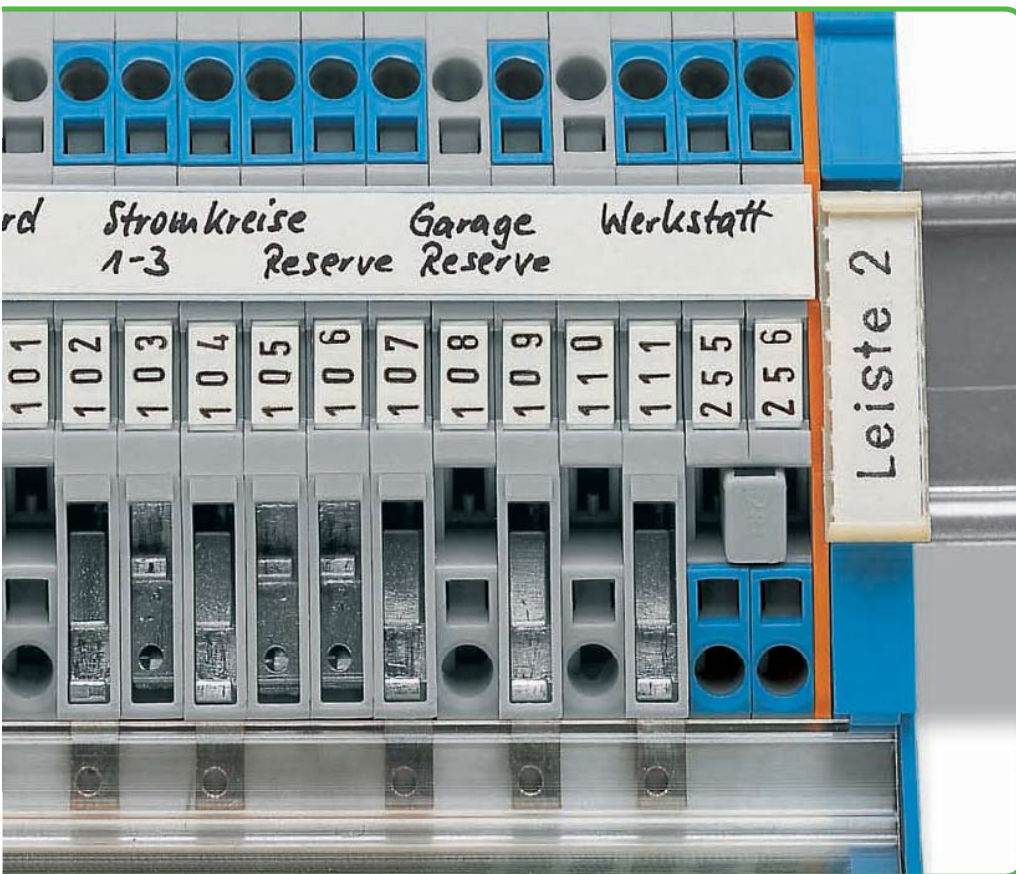

Group marker carriers



Group marker carrier adjustable in height

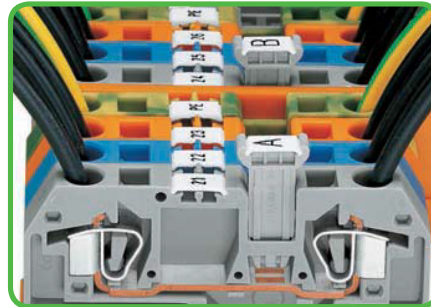

Additional group marking

Movable marking system

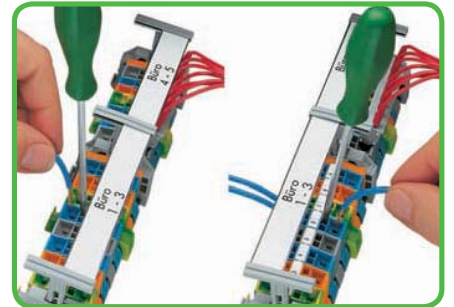

Additional continuous marking strips

Group Marker Carriers (Height-Adjustable) and Movable Marking System

Height-adjustable group marker carrier	Carrier-through element
--	-------------------------

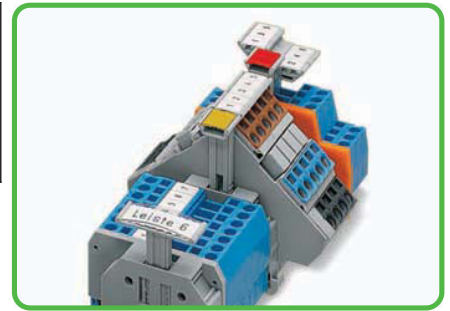

Receptacles for:
 1 x marker
 2 x WMB (Multi marking) or
 3 x WCB (Combi marking) or
 1 x WFB (Continuous marking strips)



Item No.	Pack. Unit	Item No.	Pack. Unit
Height-adjustable group marker carrier, snap-on type and height-adjustable from 43.5 mm to 59.5 mm in 249-116 and 249-117 end stops, for 1 marker or self-adhesive label and transparent protection covers, 10 mm wide ○ gray		Carrier-through element, height-adjustable ○ gray	
249-119	50 (2x25)	709-118	50 (2x25)
snap-on type and height-adjustable from 43.5 mm to 59.5 mm in 249-116 and 249-117 end stops, for 2 WMB markers or 1 x continuous strip, 10 mm wide ○ gray		Carrier-end element, height-adjustable ○ gray	
249-118	100 (4x25)	709-119	50 (2x25)
snap-on type and height-adjustable from 42.2 mm to 58.2 mm in 249-116 and 249-117 end stops, with marker surface, 6 mm wide ○ white			
249-120	50 (2x25)		
snap-on type and height-adjustable from 45 mm to 61 mm in 249-116 and 249-117 end stops, for 2 WMB markers or 1 x TOPJOB®S marking strips, 12.2 mm wide ○ gray			
2009-163	50 (2x25)		
Item-Specific Accessories			
Marking strip carrier,			
folded, 1 m long, 16 mm wide, 1.7 mm thick transparent			
	709-120	1	
Marking card,			
with 14 marking strips, DIN A4			
	709-193	1	

This system can be used as an additional group marker carrier or continuous marking strip carrier for terminal strips or single-deck rail-mount terminal blocks, for example:

- 264 Series terminal strips for DIN 35 rails
- 279 to 284 Series single-deck rail-mount terminal blocks, with a maximum height of 49 mm/1.93 in from the upper edge of the carrier rail (please observe conductor radius).

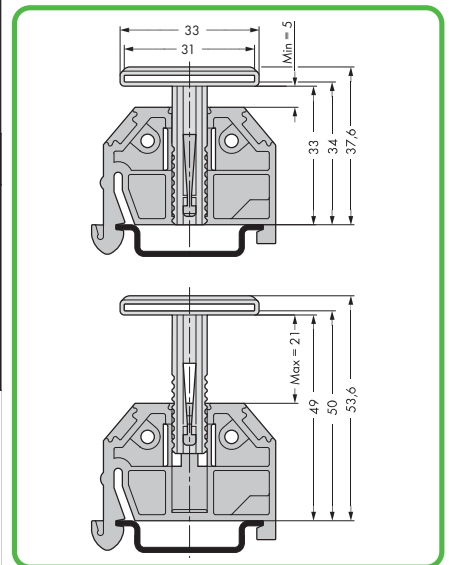

Dimensions in mm



Height-adjustable group marker carrier for TOPJOB®S marking strips