

LON[®] Data Exchange Coupler (Peer to Peer)

78 kbps; digital and analog signals

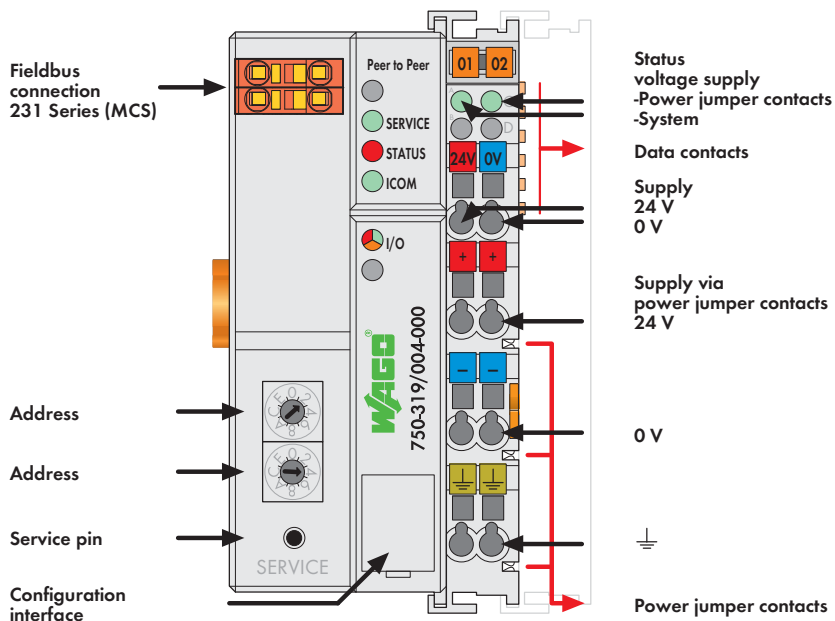

The data exchange coupler transfers the input process image data to the output process image of the coupled partner. The data exchange coupler is a variant of the LON[®] fieldbus coupler.

Applications:

- **Peer to Peer**
one master and one slave
- **Broadcast**
one master and several slaves

The coupler, together with I/O modules, is a fieldbus node which is connected to other nodes by means of a twisted wire pair. The coupler can also be integrated into existing LON[®] networks if appropriate node addresses are available.

The coupler automatically creates the process image using the types and widths of data of the connected I/O modules. The input process image is transferred to the output process image of the partner or partners.

The monitoring system switches digital outputs off or stores the last analog value if the connection to the coupled partner is interrupted longer than 1 second.

LON[®] is a registered trademark of Echelon Corporation.

Description	Item No.	Pack. Unit
Peer to Peer Coupler	750-319/004-000	1
Accessories		
Miniature WSB Quick marking system		
 plain	248-501	5
with marking	see pages 352 ... 353	
Approvals		
Also see "Approvals Overview" in Section 1		
Conformity marking	CE	
UL 508		
ANSI/ISA 12.12.01	Class I, Div. 2, Grp. ABCD, T4	
IEC 60079-0, -15	BR-Ex nA II T4	
EN 60079-0, -15	I M2 / II 3 GD Ex nA nL IIC T4	
EN 61241-0, -1		

System Data	
No. of couplers connected to Master	64 without repeater, 127 with repeater
Transmission medium	Twisted pair - FTT
Max. length of fieldbus segment	500 m (free topology) 2700 m (bus-topology)
Topology	in accordance with LON specification
Baud rate	78 kbps
Buscoupler connection	2-pole male connector, 231 Series (MCS), female connector (231-302) (included)

1 4-Channel Digital Input Module 24 V DC
2-conductor connection; high-side switching

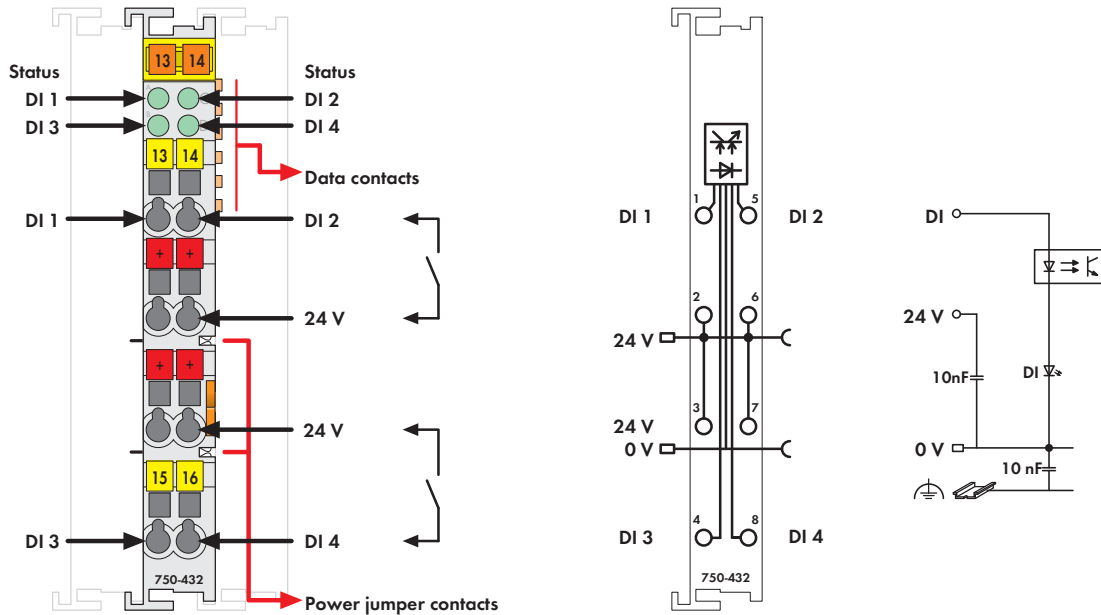



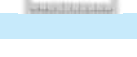
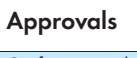





Fig. 750 Series/Technical data see page 24/Delivered without miniature WSB markers
750/753 Series marking see pages 10 ... 11 / 12 ... 13

The digital input module receives control signals from digital field devices (sensors, etc.).

The module is a 4-input channel, 2-conductor device. Due to its four 24V connections, four sensors may be directly connected to the module.

Each input module has a noise-rejection filter. This filter is available with different time constants.

An optocoupler is used for electrical isolation between the bus and the field side.

Description	Item No.	Pack. Unit
4DI 24V DC 3.0ms/2-conductor	750-432	1
4DI 24V DC 0.2ms/2-conductor	750-433	1
4DI 24V DC 3.0ms/2-conductor (without connector)	753-432	1
4DI 24V DC 0.2ms/2-conductor (without connector)	753-433	1
Accessories	Item No.	Pack. Unit
 753 Series Connectors	753-110	25
 Coding elements	753-150	100
Miniature WSB Quick marking system		
 plain	248-501	5
 with marking	see pages 352 ... 353	
Approvals	Also see "Approvals Overview" in Section 1	
Conformity marking	CE	
Shipbuilding	ABS, BV, DNV, GL, KR, LR*, NKK*, PRS*, RINA* *753 Series, pending	
 UL 508		
 ANSI/ISA 12.12.01	Class I, Div. 2, Grp. ABCD, T4	
 EN 60079-0, -15	I M2 / II 3 GD Ex nA IIC T4	75x-432, 753-433
 EN 61241-0, -1		
 EN 60079-0, -11, -15	I M2 Ex d I	750-433*
 EN 61241-0, -1, -11	II 3 G Ex nA IIC T4	750-433*
	II 3 D Ex tD A22 IP6X T135°C	750-433*
	* Permissible operating temperature: 0°C ... +60°C	

Technical Data	
Number of inputs	4
Current consumption (internal)	5.5 mA
Voltage via power jumper contacts	24 V DC (-25 % ... +30 %)
Signal voltage (0)	-3 V ... +5 V DC
Signal voltage (1)	15 V ... 30 V DC
Input filter	3.0 ms (750-432 / 753-432) 0.2 ms (750-433 / 753-433)
Input current (typ.)	4.5 mA
Isolation	500 V system/supply
Internal bit width	4 bits in
Wire connection	CAGE CLAMP®
Cross sections	0.08 mm² ... 2.5 mm² / AWG 28 ... 14
Stripped lengths, 750/753 Series	8 ... 9 mm / 0.33 in 9 ... 10 mm / 0.37 in
Width	12 mm
Weight	48.5 g
EMC: CE - immunity to interference	acc. to EN 61000-6-2 (2005)
EMC: CE - emission of interference	acc. to EN 61000-6-3 (2007)
EMC: marine applications	
- immunity to interference	acc. to Germanischer Lloyd (2003)
EMC: marine applications	
- emission of interference	acc. to Germanischer Lloyd (2003)