

LON[®] Data Exchange Coupler (Peer to Peer)

78 kbps; digital and analog signals

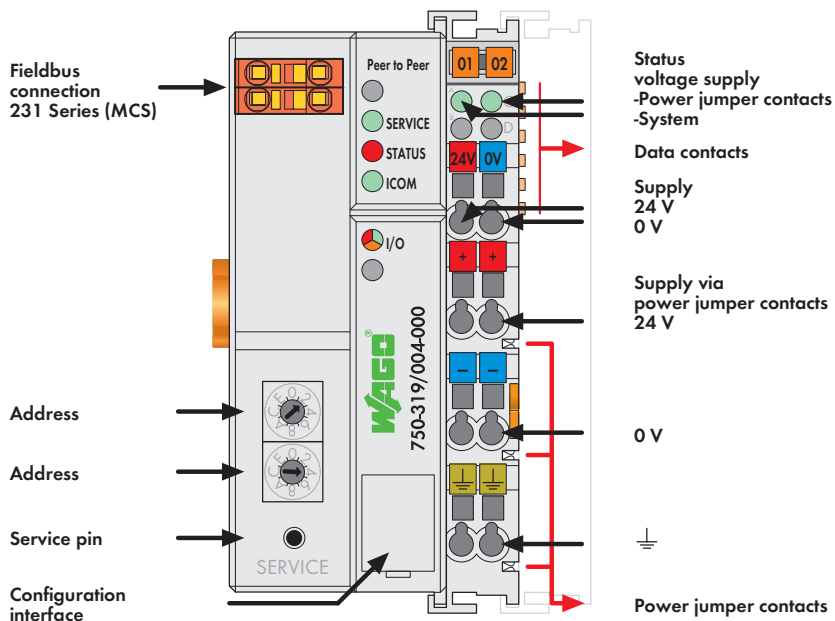

The data exchange coupler transfers the input process image data to the output process image of the coupled partner. The data exchange coupler is a variant of the LON[®] fieldbus coupler.

Applications:

- **Peer to Peer**
one master and one slave
- **Broadcast**
one master and several slaves

The coupler, together with I/O modules, is a fieldbus node which is connected to other nodes by means of a twisted wire pair. The coupler can also be integrated into existing LON[®] networks if appropriate node addresses are available.

The coupler automatically creates the process image using the types and widths of data of the connected I/O modules. The input process image is transferred to the output process image of the partner or partners.

The monitoring system switches digital outputs off or stores the last analog value if the connection to the coupled partner is interrupted longer than 1 second.

LON[®] is a registered trademark of Echelon Corporation.

Description	Item No.	Pack. Unit
Peer to Peer Coupler	750-319/004-000	1
Accessories		
Miniature WSB Quick marking system		
 plain	248-501	5
with marking	see pages 352 ... 353	
Approvals		
Also see "Approvals Overview" in Section 1		
Conformity marking	CE	
UL 508		
ANSI/ISA 12.12.01	Class I, Div. 2, Grp. ABCD, T4	
IEC 60079-0, -15	BR-Ex nA II T4	
EN 60079-0, -15	I M2 / II 3 GD Ex nA nL IIC T4	
EN 61241-0, -1		

System Data	
No. of couplers connected to Master	64 without repeater, 127 with repeater
Transmission medium	Twisted pair - FTT
Max. length of fieldbus segment	500 m (free topology) 2700 m (bus-topology)
Topology	in accordance with LON specification
Baud rate	78 kbps
Buscoupler connection	2-pole male connector, 231 Series (MCS), female connector (231-302) (included)

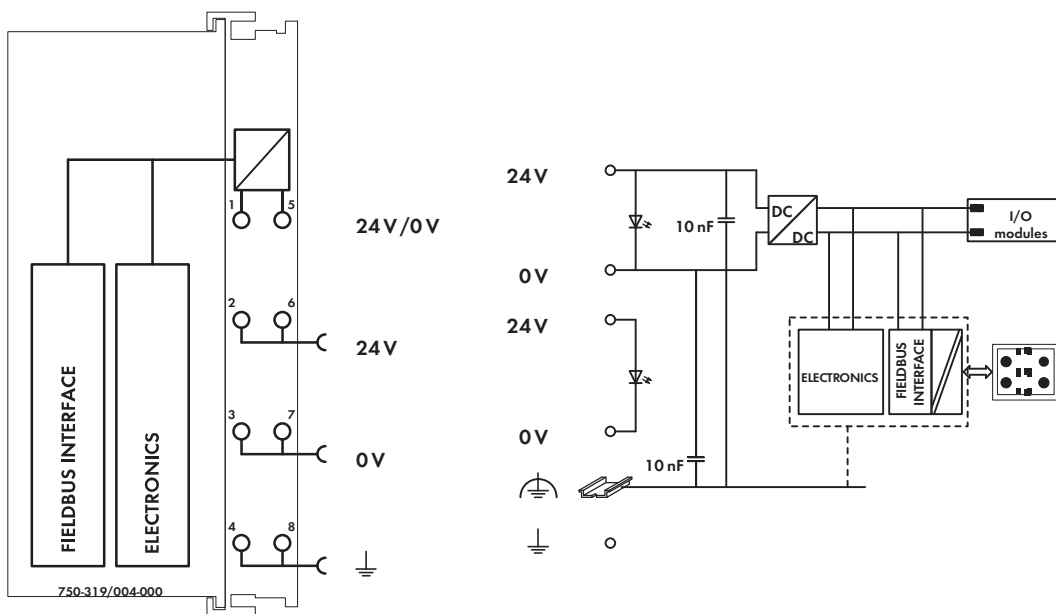

Technical Data

Number of I/O modules	62
Digital signals	max. 248 (in- and outputs)
Analog signals	max. 124 (in- and outputs)
Configuration	via PC with LON Interface
Power supply	24 V DC (-15 % ... +20 %)
Max. input current (24 V)	500 mA
Efficiency of the power supply	87 %
Internal current consumption (5 V)	300 mA
Total current for I/O modules (5 V)	1700 mA
Isolation	500 V system/supply
Voltage via power jumper contacts	24 V DC (-15 % ... +20 %)
Current via power jumper contacts (max.)	10 A DC
Transceiver	FTT 10 A

General Specifications

Operating temperature	0 °C ... +55 °C
Wire connection	CAGE CLAMP [®]
Cross sections	0.08 mm ² ... 2.5 mm ² / AWG 28 ... 14
Stripped lengths	8 ... 9 mm / 0.33 in
Dimensions (mm) W x H x L	51 x 65 x 100
	Height from upper-edge of DIN 35 rail
Weight	200 g
Storage temperature	-25 °C ... +85 °C
Relative air humidity (no condensation)	95 %
Vibration resistance	acc. to IEC 60068-2-6
Shock resistance	acc. to IEC 60068-2-27
Degree of protection	IP20
EMC: CE - immunity to interference	acc. to EN 61000-6-2 (2005)
EMC: CE - emission of interference	acc. to EN 61000-6-4 (2007)

2-Channel Digital Input Module 24 V DC

2- to 4-conductor connection; high-side switching

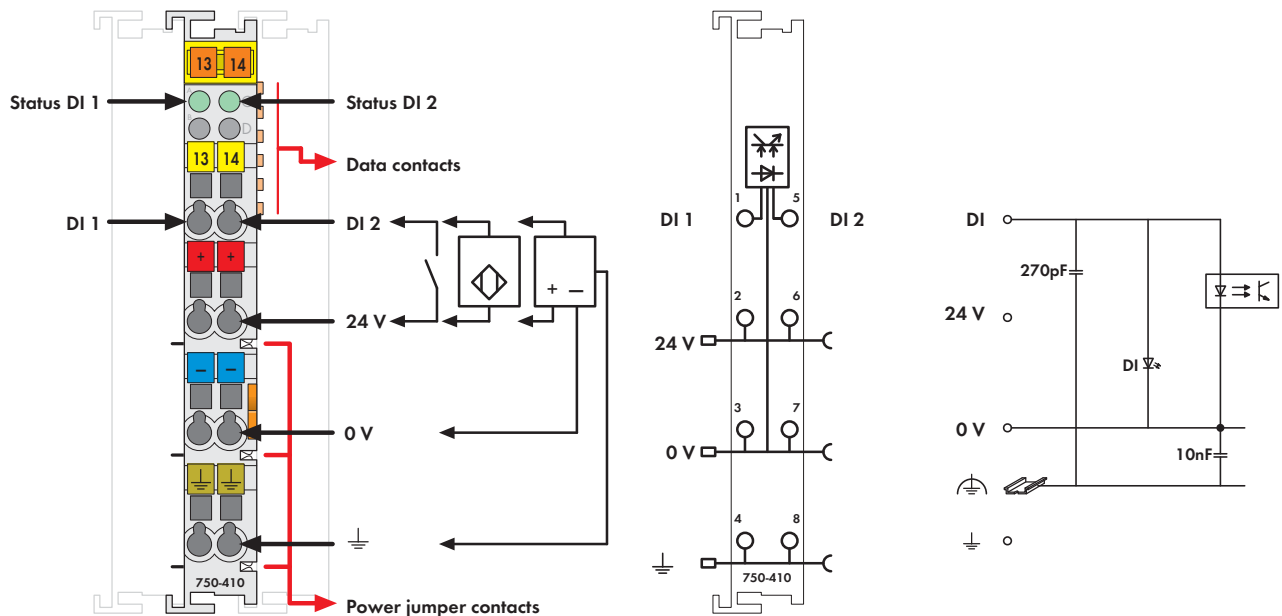

Fig. 750 Series/Technical data see page 24/Delivered without miniature WSB markers
750/753 Series marking see pages 10 ... 11 / 12 ... 13







The digital input module receives the control signal from digital field devices (sensors, etc.).

A 2-wire proximity switch can be connected to this module.

The module is a 2-channel, 4-conductor device and sensors with a ground (earth) wire may be directly connected to the module.

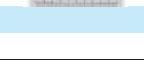
Each input module has a noise-rejection filter. This filter is available with different time constants.

An optocoupler is used for electrical isolation between the bus and the field side.

Description	Item No.	Pack. Unit
2DI 24V DC 3.0ms, proximity switch	750-410	10 ¹⁾
2DI 24V DC 0.2ms, proximity switch	750-411	1
2DI 24V DC 3.0ms, proximity switch (without connector)	753-410	1
2DI 24V DC 0.2ms, proximity switch (without connector)	753-411	1
¹⁾ Also available individually		
Accessories	Item No.	Pack. Unit
 753 Series Connectors	753-110	25
 Coding elements	753-150	100
Miniature WSB Quick marking system		
 plain	248-501	5
 with marking	see pages 352 ... 353	
Approvals	Also see "Approvals Overview" in Section 1	
Conformity marking	CE	
Shipbuilding	ABS, BV, DNV, GL, KR, LR*, NKK*, PRS*, RINA* *753 Series, pending	
 UL 508		
 ANSI/ISA 12.12.01	Class I, Div. 2, Grp. ABCD, T4	
 EN 60079-0, -15	I M2 / II 3 GD Ex nA IIC T4	
 EN 61241-0, -1		

Technical Data	
Number of inputs	2
Max. current consumption (internal)	2.5 mA
Voltage via power jumper contacts	24 V DC (-25 % ... +30 %)
Signal voltage (0)	-3 V ... +5 V DC
Signal voltage (1)	15 V ... 30 V DC
Input filter	3.0 ms (750-410 / 753-410) 0.2 ms (750-411 / 753-411)
Input current (typ.)	8 mA
Isolation	500 V system/supply
Internal bit width	2 bits
Wire connection	CAGE CLAMP®
Cross sections	0.08 mm ² ... 2.5 mm ² / AWG 28 ... 14
Stripped lengths, 750/753 Series	8 ... 9 mm / 0.33 in 9 ... 10 mm / 0.37 in
Width	12 mm
Weight	48.5 g
EMC: CE - immunity to interference	acc. to EN 61000-6-2 (2005)
EMC: CE - emission of interference	acc. to EN 61000-6-4 (2007)
EMC: marine applications	
- immunity to interference	acc. to Germanischer Lloyd (2003)
EMC: marine applications	
- emission of interference	acc. to Germanischer Lloyd (2003)