

Description and Handling

MCS - MULTISTECKERSYSTEM MIDI Classic

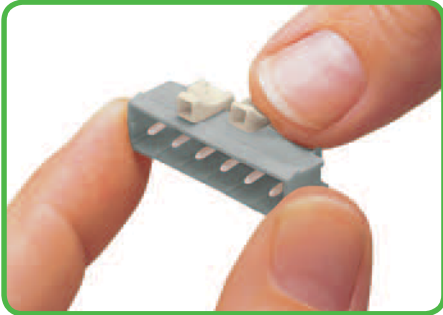

Coding a male header - fitting coding key(s).



Coding a female connector - removing coding finger(s).

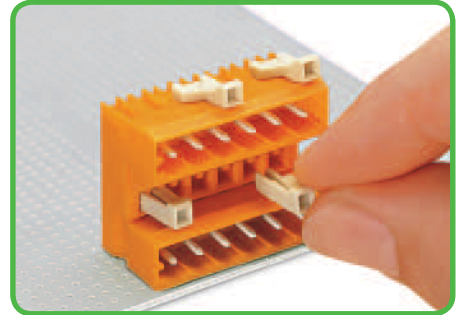

Coding a lower male header - inserting coding key(s).

2231 Series Female Connectors with Push-Buttons

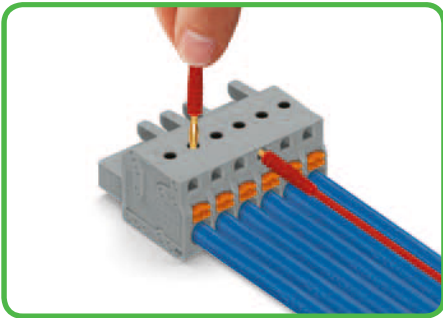

Testing parallel to conductor entry via Ø 2 mm test plugs - female connector with CAGE CLAMP®S. Tip contact with current bar perpendicular to conductor entry.

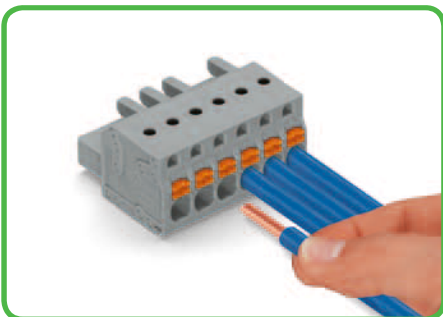

Inserting solid and ferruled, fine-stranded conductors via CAGE CLAMP®S push-in termination.

CAGE CLAMP®S

MCS-MIDI Classic

Pin spacing 5 mm and 7.5 mm
Pin spacing 5.08 mm and 7.62 mm

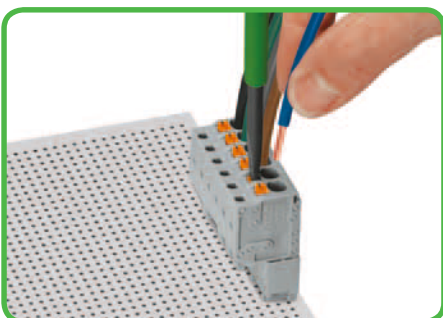

Inserting fine-stranded conductor into CAGE CLAMP®S unit via push-button.



THR male headers in tape-and-reel packaging for SMT applications.

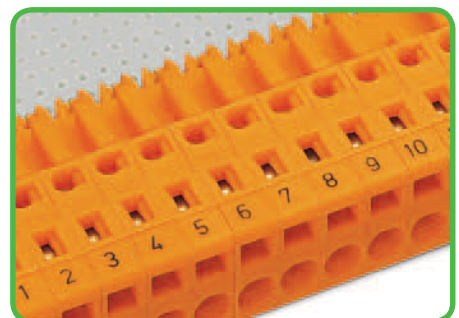

Marking via self-adhesive marker strips or factory direct printing.

CAGE CLAMP® and CAGE CLAMP®S clamp the following copper conductors:*

- solid

stranded

fine-stranded, also with tinned single strands

* For aluminum conductors, see notes in Section 11.

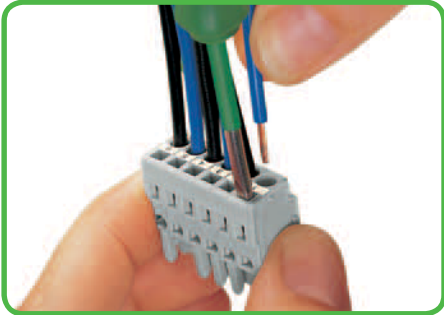

Inserting conductor via 3.5 mm screwdriver – CAGE CLAMP® actuation parallel to conductor entry.

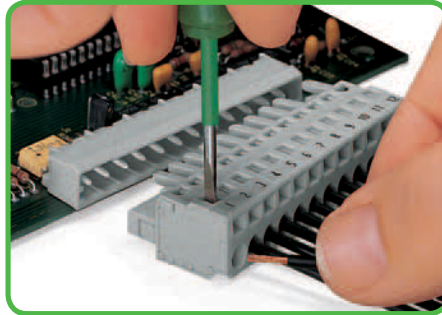

Inserting conductor via 3.5 mm screwdriver – CAGE CLAMP® actuation perpendicular to conductor entry.

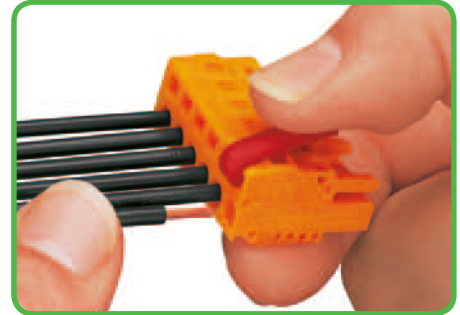

Inserting conductor into CAGE CLAMP® unit via 231-291 operating lever.

231, 232, 731 and 732 Series

CAGE CLAMP®

MCS-MIDI Classic

Pin spacing 5 mm and 7.5 mm
Pin spacing 5.08 mm and 7.62 mm

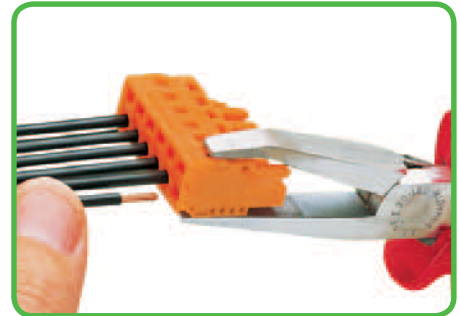

Inserting conductor into CAGE CLAMP® unit via 210-250 operating tool.

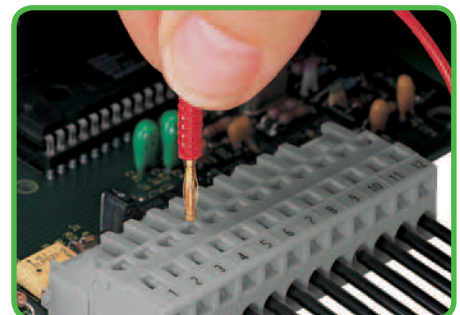

Testing perpendicular to conductor entry via Ø 2 mm or Ø 2.3 mm test plugs – female connector with CAGE CLAMP®.

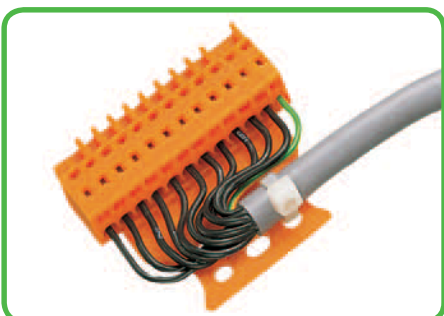

Female connector with strain relief plate.

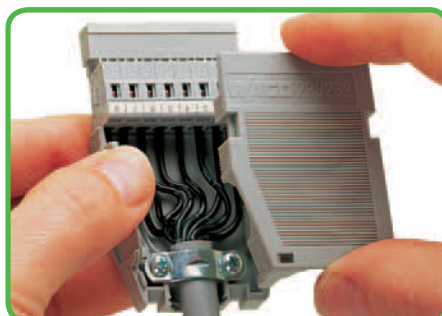

Strain relief housing for male and female connectors equipped with CAGE CLAMP®.

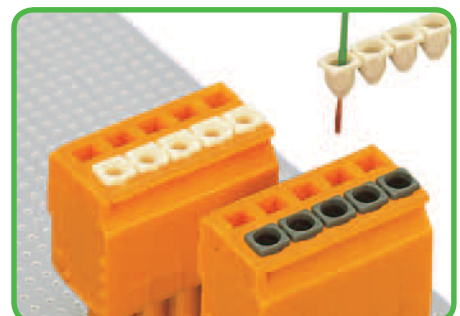

Insulation stop – prevents conductor insulation from being inserted into the clamping unit for CAGE CLAMP® and CAGE CLAMP®S.



fine-stranded, tip-bonded



fine-stranded with crimped ferrules (gas-tight)



fine-stranded with crimped pin terminal (gas-tight)

Female Connectors Pin Spacing 5 mm, 5.08 mm MCS-MIDI Classic

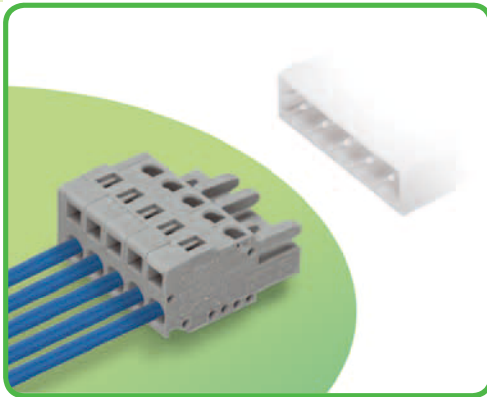

- Universal connection for all conductor types
- Easy cable pre-assembly and on-unit wiring via vertical and horizontal CAGE CLAMP® actuation
- With coding fingers
- Integrated test ports

Technical data:

Pin Spacing	Straight female connectors:			Angled female connectors:		
	5 mm/5.08 mm 0.197 in/0.2 in			5 mm/5.08 mm 0.197 in/0.2 in		
Rating per	IEC/EN 60664-1			IEC/EN 60664-1		
Overtoltage category	III	III	II	III	III	II
Pollution degree	3	2	2	3	2	2
Rated voltage	320 V	320 V	630 V	320 V	320 V	630 V
Rated surge voltage	4 kV	4 kV	4 kV	4 kV	4 kV	4 kV
Nominal current	16 A	16 A	16 A	14 A	14 A	14 A
Approvals per	UL/CSA			UL/CSA		
Use group UL 1059	B	C	D	B	C	D
Rated voltage	300 V	-	300 V	300 V	-	300 V
Nominal current UL	15 A	-	10 A	15 A	-	10 A
Nominal current CSA	15 A	-	10 A	15 A	-	10 A

The MCS-MIDI connection system is UL 1977 approved and capable of up to 600 V for factory wiring.

Conductor data:

Connection technology	CAGE CLAMP®	
Conductor size: solid	0.08 - 2.5 mm ²	
Conductor size: fine-stranded	0.08 - 2.5 mm ²	
Conductor size: fine-stranded	0.25 - 1.5 mm ² (with insulated ferrule)	
Conductor size: fine-stranded	0.25 - 2.5 mm ² (with uninsulated ferrule)	
AWG	28 - 12	12: THHN, THWN
Strip length	8 - 9 mm / 0.31 - 0.35 in	

Material data:

Material group	I
Insulating material	Nylon 6.6 (PA 6.6)
Flammability rating per UL 94	V0
Lower/Upper temperature limit	-60°C / +85°C
Clamping spring material	Chrome-nickel spring steel (CrNi)
Contact material	Copper alloy
Contact plating	tin-plated
MCS connectors are also available upon request with gold-plated or partially gold-plated contact surfaces.	
Depending on the version requested, "item no. suffix ... /010-000" is added to the "basic item no."	

MCS - MULTI CONNECTION SYSTEM includes connectors **without** breaking capacity in accordance with IEC 61984. When used as intended, these connectors shall not be connected/disconnected when live or under load. The circuit design should ensure header pins, which can be touched, are not live in unmated condition.

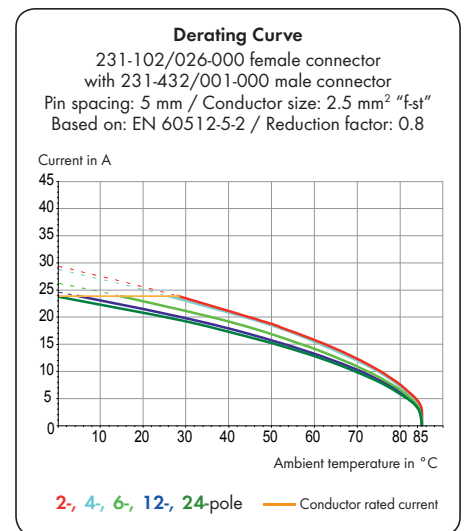

MCS-MIDI accessories:

Page:

Marking accessories	540 - 543
Operating tools	466 - 467
Direct marking	358 - 360
Comb-style jumper bars	476
Insulation stop	469
Test plug adapter	474
Test plugs	538
Screws	546
Strain relief housings	472 - 473
Strain relief plates	470 - 471

Female Connectors MCS-MIDI Classic

With locking levers Pin spacing 5.08 mm / 0.2 in		With snap-in mounting feet Pin spacing 5.08 mm / 0.2 in		With screw flanges Pin spacing 5.08 mm / 0.2 in	
0.08 - 2.5 mm ² 320 V/4 kV/2 16 A	AWG 28 - 12 300 V/15 A	0.08 - 2.5 mm ² 320 V/4 kV/2 16 A	AWG 28 - 12 300 V/15 A	0.08 - 2.5 mm ² 320 V/4 kV/2 16 A	AWG 28 - 12 300 V/15 A

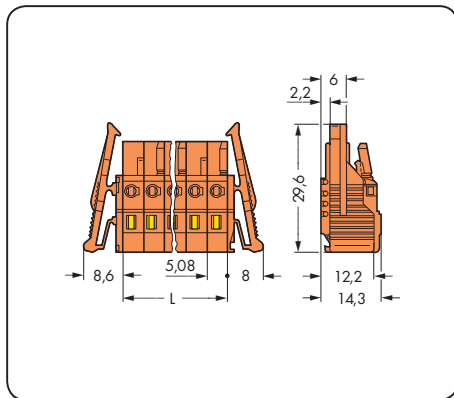
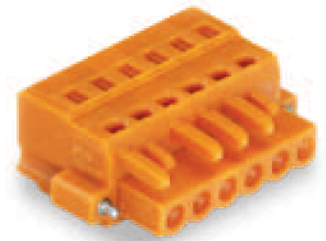
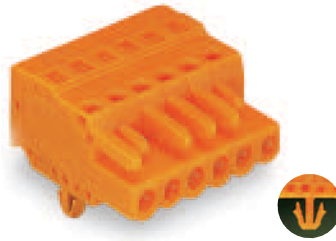

L = pole no. x pin spacing

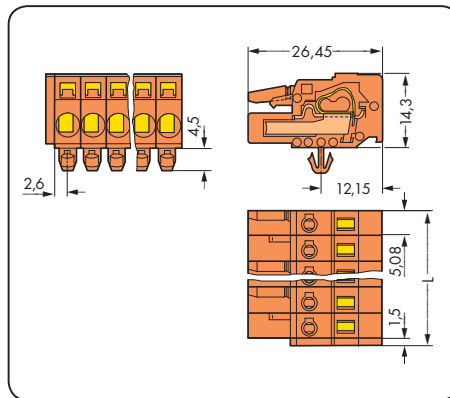

L = (pole no. x pin spacing) + 1.5 mm

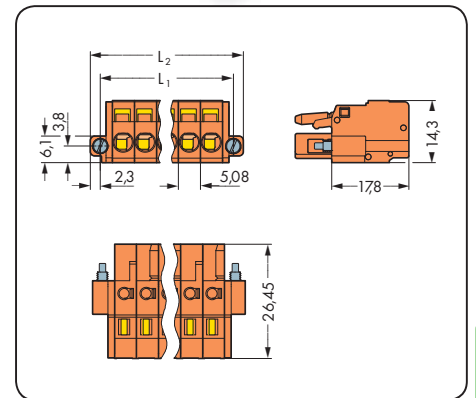

L₁ = (pole no. x pin spacing) + 5.4 mm
L₂ = (pole no. x pin spacing) + 10 mm

Pole No.	Item No.	Pack. Unit	Pole No.	Item No.	Pack. Unit	Pole No.	Item No.	Pack. Unit
Female connector with locking levers, orange			Female connector with snap-in mounting feet, for 0.6 - 1.2 mm plate thickness, Ø 3.5 mm mounting holes, orange			Female connector with screw flanges, orange		
2	231-302/037-000	100	2	231-302/008-000	100	2	231-302/107-000	100
3	231-303/037-000	50	3	231-303/008-000	100	3	231-303/107-000	100
4	231-304/037-000	50	4	231-304/008-000	100	4	231-304/107-000	50
5	231-305/037-000	50	5	231-305/008-000	100	5	231-305/107-000	50
6	231-306/037-000	50	6	231-306/008-000	50	6	231-306/107-000	50
7	231-307/037-000	50	7	231-307/008-000	50	7	231-307/107-000	50
8	231-308/037-000	25	8	231-308/008-000	50	8	231-308/107-000	50
9	231-309/037-000	25	9	231-309/008-000	50	9	231-309/107-000	25
10	231-310/037-000	25	10	231-310/008-000	50	10	231-310/107-000	25
11	231-311/037-000	25	11	231-311/008-000	25			
12	231-312/037-000	25	12	231-312/008-000	25	12	231-312/107-000	25
13	231-313/037-000	25	13	231-313/008-000	25			
14	231-314/037-000	25	14	231-314/008-000	25	14	231-314/107-000	25
15	231-315/037-000	25	15	231-315/008-000	25	15	231-315/107-000	25
16	231-316/037-000	10	16	231-316/008-000	25	16	231-316/107-000	10
17	231-317/037-000	10	17	231-317/008-000	25			
18	231-318/037-000	10	18	231-318/008-000	10			
19	231-319/037-000	10	19	231-319/008-000	10			
20	231-320/037-000	10	20	231-320/008-000	10			
21	231-321/037-000	10	21	231-321/008-000	10			
22	231-322/037-000	10	22	231-322/008-000	10			
23	231-323/037-000	10	23	231-323/008-000	10	For other lengths, please contact factory.		
24	231-324/037-000	10	24	231-324/008-000	10			
2- to 3-pole female connectors - one latch only								

Product Accessories	Page
Mounting adapter for DIN 35 rail, min. length 3 poles (209-137)	475