

Description and Handling

MCS - MULTI CONNECTION SYSTEM MIDI 100% Protected Against Mismatching

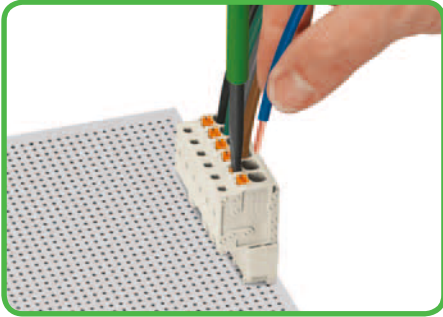

Inserting/removing conductor via 3.5 mm screwdriver - CAGE CLAMP®S actuation in mated condition.

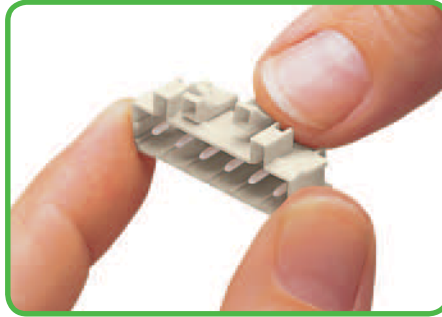

Coding a male header - fitting coding key(s).



Coding a female connector - removing coding finger(s).

2721 Series Female Connector with Push-Buttons

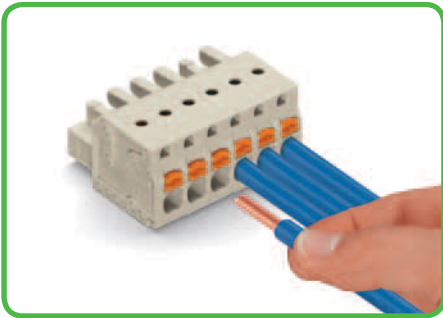

Inserting solid or ferruled conductors via CAGE CLAMP®S push-in terminations.

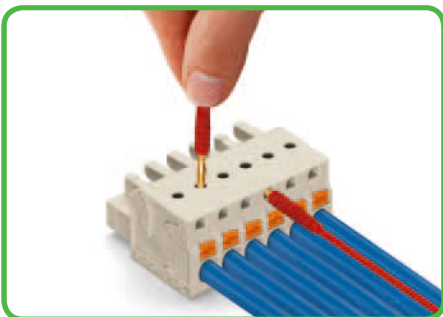

Testing parallel to conductor entry via integrated test ports - female connector with push-button actuated CAGE CLAMP®S. Tip contact with current bar from top of unit.

100% protected against mismatching

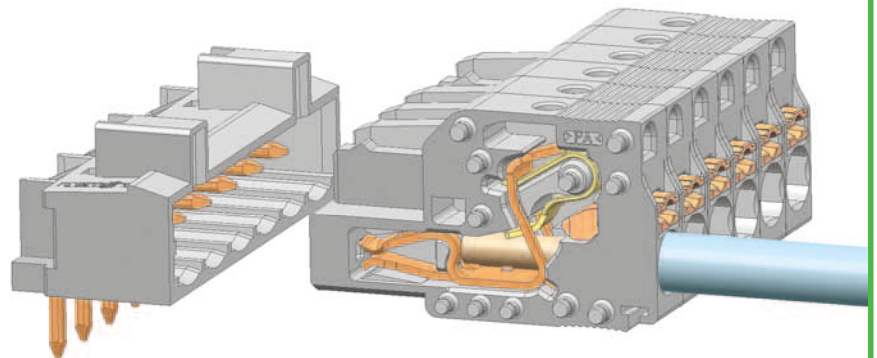

MCS-MIDI

Pin spacing 5 mm and 7.5 mm



Marking via self-adhesive marker strips or factory direct printing.

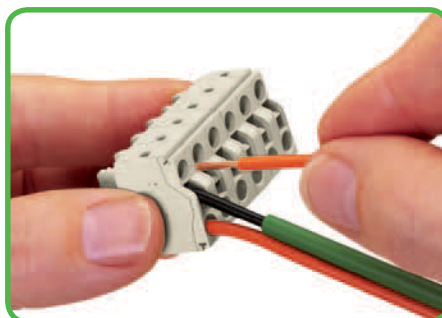

Inserting conductor via 3.5 mm screwdriver into a 2-conductor female connector equipped with CAGE CLAMP®S.

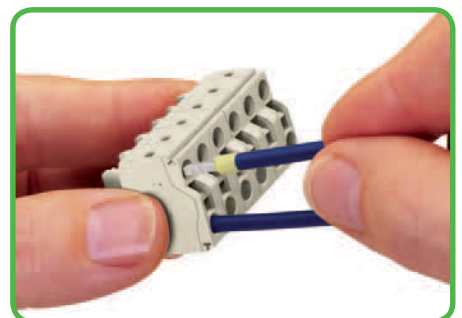

Inserting ferruled, fine-stranded conductors via CAGE CLAMP®S push-in terminations.

CAGE CLAMP® and CAGE CLAMP®S clamp the following copper conductors:*

solid

stranded

fine-stranded, also with tinned single strands

* For aluminum conductors, see notes in Section 11.

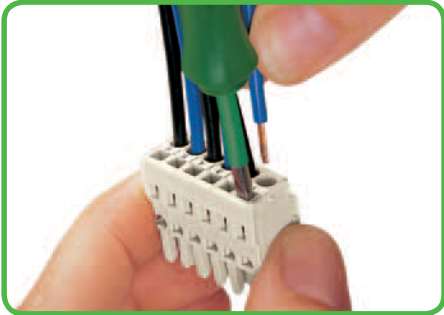

Inserting conductor via 3.5 mm screwdriver - horizontal CAGE CLAMP® actuation.

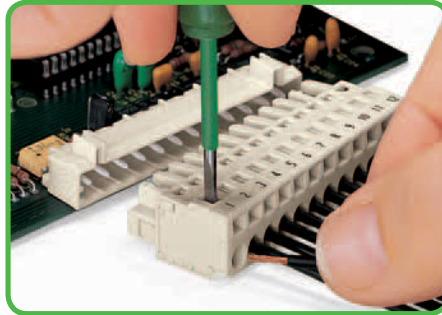

Inserting conductor via 3.5 mm screwdriver - vertical CAGE CLAMP® actuation.

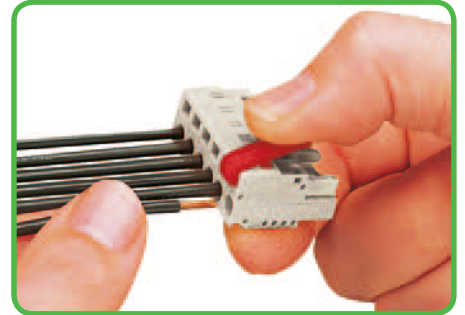

Inserting conductor - CAGE CLAMP® actuation via 231-291 push-buttons.

721, 722 and 723 Series

100% protected against mismatching

CAGE CLAMP®

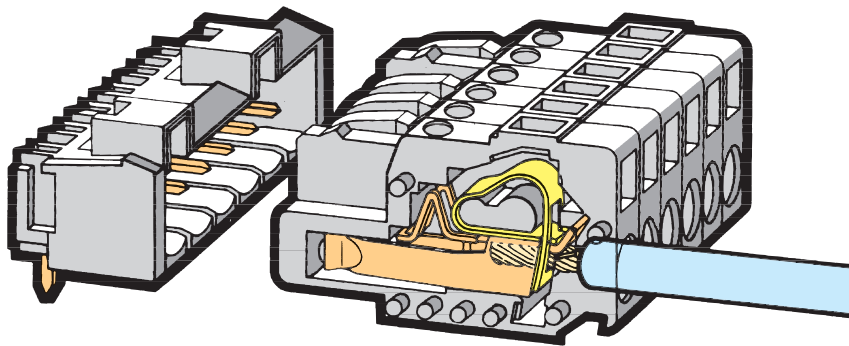

MCS-MIDI

Pin spacing 5 mm and 7.5 mm

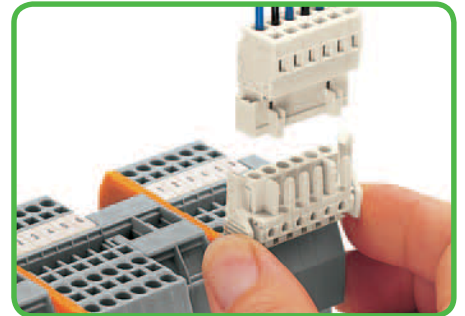

Connectors for 280 Series rail-mounted terminal blocks.

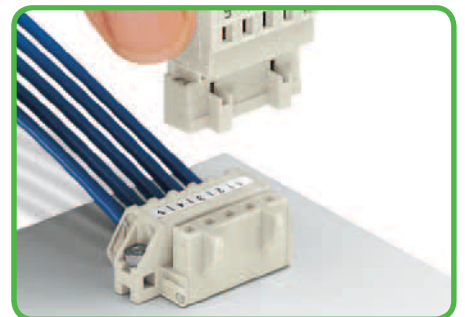

Angled female connector for panel mounting.



Male connector with strain relief plate.

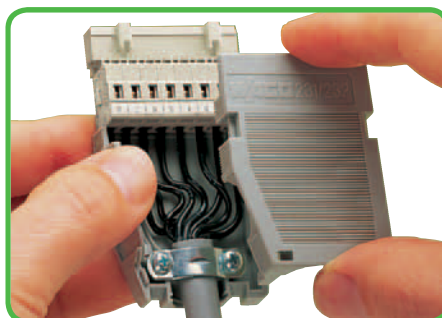

Strain relief housing shown with a male connector equipped with CAGE CLAMP®.

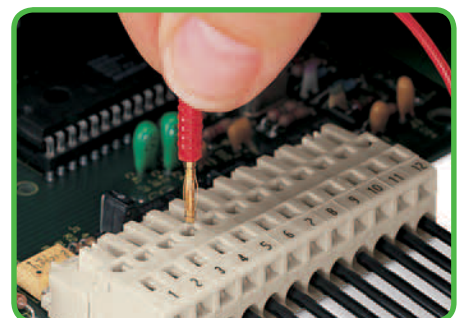

Testing - female connector with CAGE CLAMP®. Vertical insertion of Ø 2 mm and Ø 2.3 mm test plugs.



fine-stranded,
tip-bonded



fine-stranded with
crimped ferrules
(gas-tight)



fine-stranded with
crimped pin terminal
(gas-tight)

Male Connectors Pin Spacing 5 mm MCS-MIDI

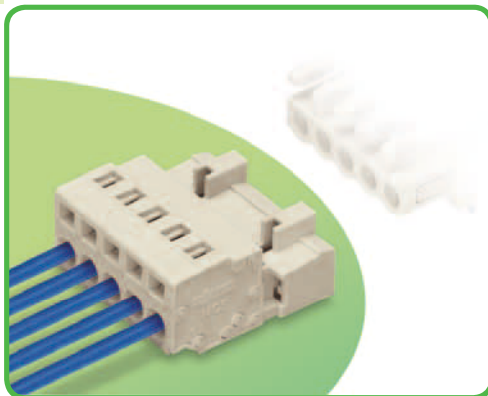

- Universal connection for all conductor types
- Easy cable pre-assembly and on-unit wiring via vertical and horizontal CAGE CLAMP® actuation
- For “wire-to-wire” and “board-to-wire” connections
- Versions available with snap-in mounting feet or fixing flanges for panel or through-panel mounting
- Optional, preceding ground contact available for 3- to 5-pole male connectors
- 100 % protected against mismatching
- With coding keys

Technical data:

Pin Spacing	5 mm 0.197 in		
Rating per	IEC/EN 60664-1		
Overtoltage category	III	III	II
Pollution degree	3	2	2
Rated voltage	320 V	320 V	630 V
Rated surge voltage	4 kV	4 kV	4 kV
Nominal current	12 A	12 A	12 A
Approvals per	UL/CSA		
Use group UL 1059	B	C	D
Rated voltage	300 V	-	300 V
Nominal current UL	15 A	-	10 A
Nominal current CSA	15 A	-	10 A

The MCS-MIDI connection system is UL 1977 approved and capable of up to 600 V for factory wiring.

Conductor data:

Connection technology	CAGE CLAMP®	
Conductor size: solid	0.08 - 2.5 mm ²	
Conductor size: fine-stranded	0.08 - 2.5 mm ²	
Conductor size: fine-stranded	0.25 - 1.5 mm ² (with insulated ferrule)	
Conductor size: fine-stranded	0.25 - 2.5 mm ² (with uninsulated ferrule)	
AWG	28 - 12	12: THHN, THWN
Strip length	8 - 9 mm / 0.31 - 0.35 in	

Material data:

Material group	I
Insulating material	Nylon 6.6 (PA 6.6)
Flammability rating per UL 94	V0
Lower/Upper temperature limit	-60°C / +100°C
Clamping spring material	Chrome-nickel spring steel (CrNi)
Contact material	Electrolytic copper (E _{cu})
Contact plating	tin-plated
MCS connectors are also available upon request with gold-plated or partially gold-plated contact surfaces.	
Depending on the version requested, “item no. suffix . . . /010-000” is added to the “basic item no.”	

MCS - MULTI CONNECTION SYSTEM includes connectors **without** breaking capacity in accordance with IEC 61984. When used as intended, these connectors shall not be connected/disconnected when live or under load. The circuit design should ensure header pins, which can be touched, are not live in unmated condition.

Derating Curve

721-102/026-000 female connector
with 721-602 male connector
Pin spacing: 5 mm / Conductor size: 2.5 mm² “f-st”
Based on: EN 60512-5-2 / Reduction factor: 0.8

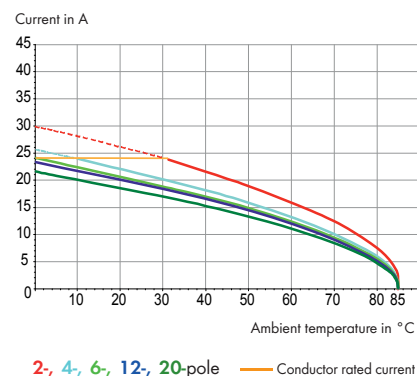

MCS-MIDI accessories:

Page:

Marking accessories	540 - 543
Operating tools	466 - 467
Direct marking	358 - 360
Comb-style jumper bars	476
Insulation stop	469
Coding keys	468
Screws	546
Strain relief housings	472 - 473
Strain relief plates	470 - 471

Pin spacing 5 mm / 0.197 in		With fixing flanges Pin spacing 5 mm / 0.197 in		With snap-in mounting feet Pin spacing 5 mm / 0.197 in	
0.08 - 2.5 mm ²	AWG 28 - 12	0.08 - 2.5 mm ²	AWG 28 - 12	0.08 - 2.5 mm ²	AWG 28 - 12
320 V/4 kV/2 12 A	300 V/15 A	320 V/4 kV/2 12 A	300 V/15 A	320 V/4 kV/2 12 A	300 V/15 A

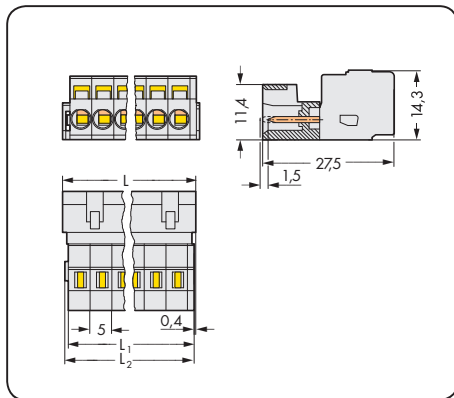
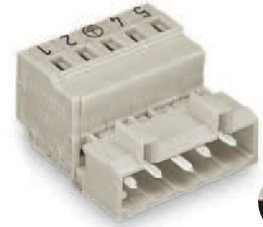
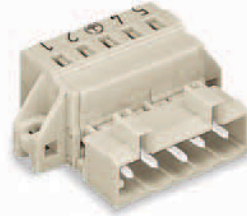
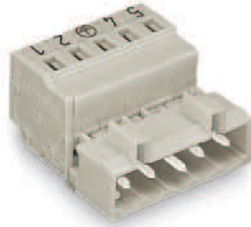

L = (pole no. - 1) x pin spacing + 8.2 mm
L₁ = L - 1.7 mm
L₂ = L - 1.2 mm

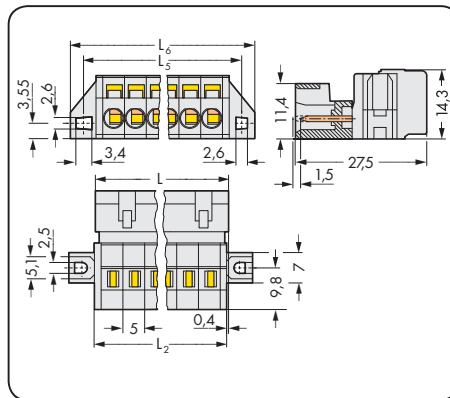

L = (pole no. - 1) x pin spacing + 8.2 mm
L₂ = L - 0.2 mm
L₅ = L₂ + 5.8 mm
L₆ = L₂ + 11.8 mm

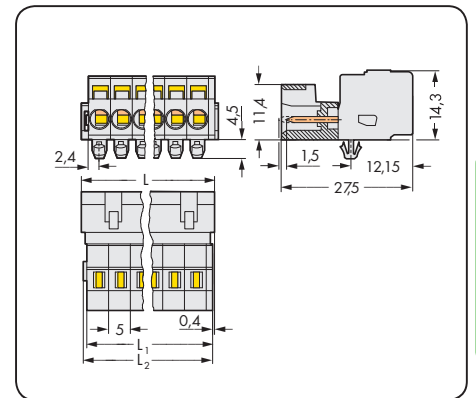

L = (pole no. - 1) x pin spacing + 8.2 mm
L₁ = L - 1.7 mm
L₂ = L - 1.2 mm

Pole No.	Item No.	Item No.	Pack. Unit	Pole No.	Item No.	Item No.	Pack. Unit	Pole No.	Item No.	Item No.	Pack. Unit
Male connector, light gray				Male connector with fixing flanges, light gray				Male connector with snap-in mounting feet, for 0.6 - 1.2 mm plate thickness, Ø 3.5 mm mounting holes, light gray			
	without preceding ground contact	with preceding ground contact and printing			without preceding ground contact	with preceding ground contact and printing			without preceding ground contact	with preceding ground contact and printing	
2	721-602		100	2	721-602/019-000		100	2	721-602/018-000		100
3	721-603	721-603/000-042	100	3	721-603/019-000	721-603/019-042	50	3	721-603/018-000	721-603/018-042	100
4	721-604	721-604/000-042	100	4	721-604/019-000	721-604/019-042	50	4	721-604/018-000	721-604/018-042	100
5	721-605	721-605/000-042	50	5	721-605/019-000	721-605/019-042	50	5	721-605/018-000	721-605/018-042	50
6	721-606		50	6	721-606/019-000		50	6	721-606/018-000		50
7	721-607		50	7	721-607/019-000		50	7	721-607/018-000		50
8	721-608		50	8	721-608/019-000		50	8	721-608/018-000		50
9	721-609		50	9	721-609/019-000		25	9	721-609/018-000		50
10	721-610		50	10	721-610/019-000		25	10	721-610/018-000		50
11	721-611		25	11	721-611/019-000		25	11	721-611/018-000		25
12	721-612		25	12	721-612/019-000		25	12	721-612/018-000		25
13	721-613		25	13	721-613/019-000		25	13	721-613/018-000		25
14	721-614		25	14	721-614/019-000		25	14	721-614/018-000		25
15	721-615		25	15	721-615/019-000		25	15	721-615/018-000		25
16	721-616		25	16	721-616/019-000		10	16	721-616/018-000		25
20	721-620		10	20	721-620/019-000		10	20	721-620/018-000		10

For cutout dimensions, see page 484, table 1.

Product Accessories **Page**

Mounting adapter for DIN 35 rail, min. length 3 poles (209-137) 475

Preceding ground contact position and on-unit markings:

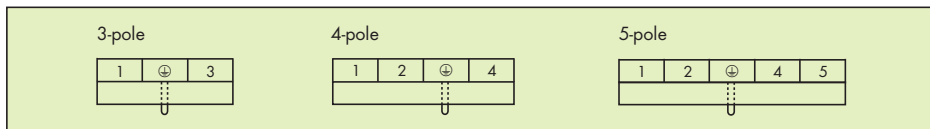

For other lengths, please contact factory.