

4-Conductor, Chassis-Mount Terminal Strips, 862 Series – Description and Handling –

CAGE CLAMP®S

Conductor termination

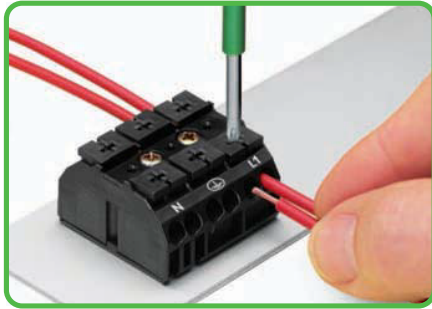

Four conductors per pole for solid and fine-stranded conductors

Marking

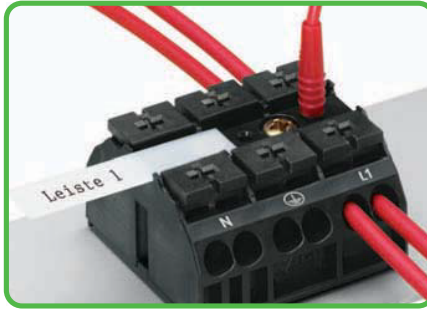

Marking by direct, one-side printing and/or marker strips

Testing

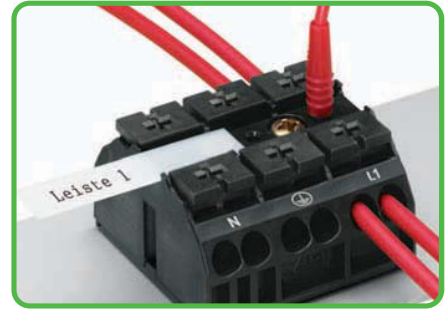

Testing with test plug 2 mm Ø.

Ground contact (PE contact)



Makes an automatic contact to the mounting plate. The varnish coating is penetrated automatically.

Commoning



Commoning with comb-style jumper bar

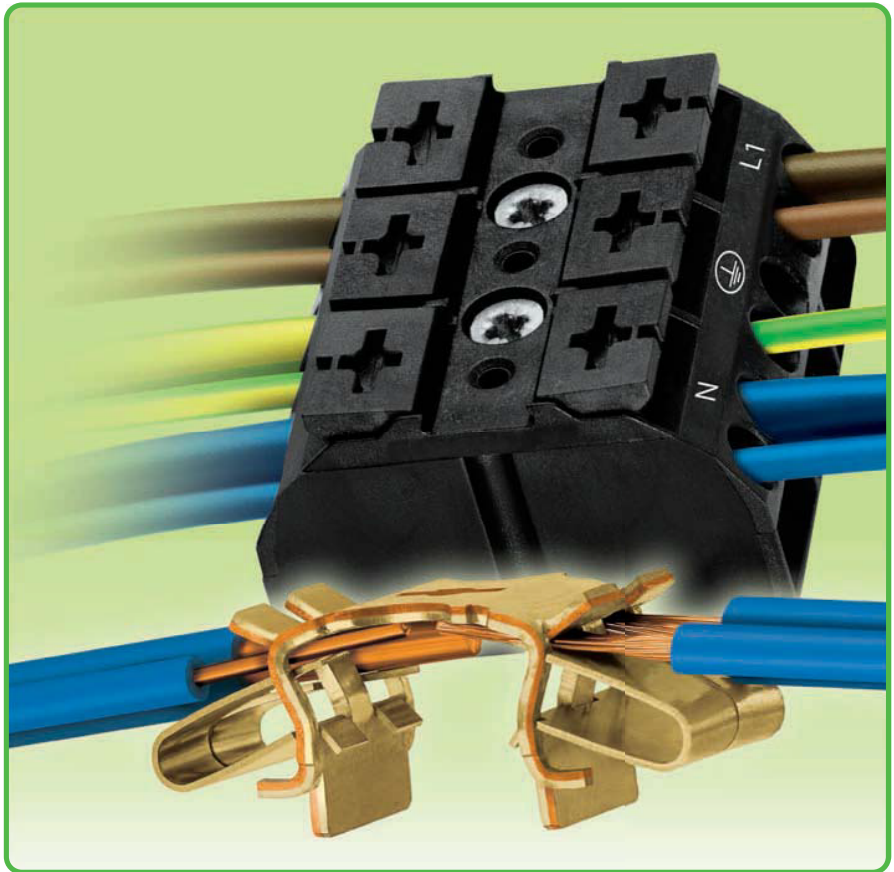

Cost-effective features:

The 862 Series chassis-mount terminal strips were developed specifically to minimize wiring costs, while accommodating requirements for easy mounting, multiple connection points, marking and handling:

- The 862 Series equipped with CAGE CLAMP®S connects up to four conductors sized 0.5 mm² to 4 mm² (AWG 20 - 12). Due to multiple connection points per pole, different conductor sizes can be used within the same terminal block position.
- CAGE CLAMP®S termination technology allows solid conductors, fine-stranded conductors with ferrules or ultrasonically bonded conductors from 0.5 mm² to 4 mm² (AWG 20 - 12) to be connected by simply pushing the conductor into contact. (Length of bonded wire end min. 10 mm/0.39 in).

- Convenient automatic grounding contact available as an option.
- Snap-in mounting feet for fast assembly.
- Push-buttons for easy handling with an operating tool or by hand.
- Built-in test points simplify testing with test plug 2 mm Ø.
- Flexible marking options with standard marking (pre-marked), marker strip or custom marked for large quantity orders.

CAGE CLAMP®S clamps the following copper conductors:*

solid

stranded

fine-stranded, also with tinned single strands

fine-stranded, tip-bonded

fine-stranded, with ferrule ① (gastight crimped)

fine-stranded, with pin terminal (gastight crimped)

* For aluminum conductors, see notes in Section 14.

① When using ferrules, the max. conductor cross section accommodated is one size smaller than max. rating of terminal block.

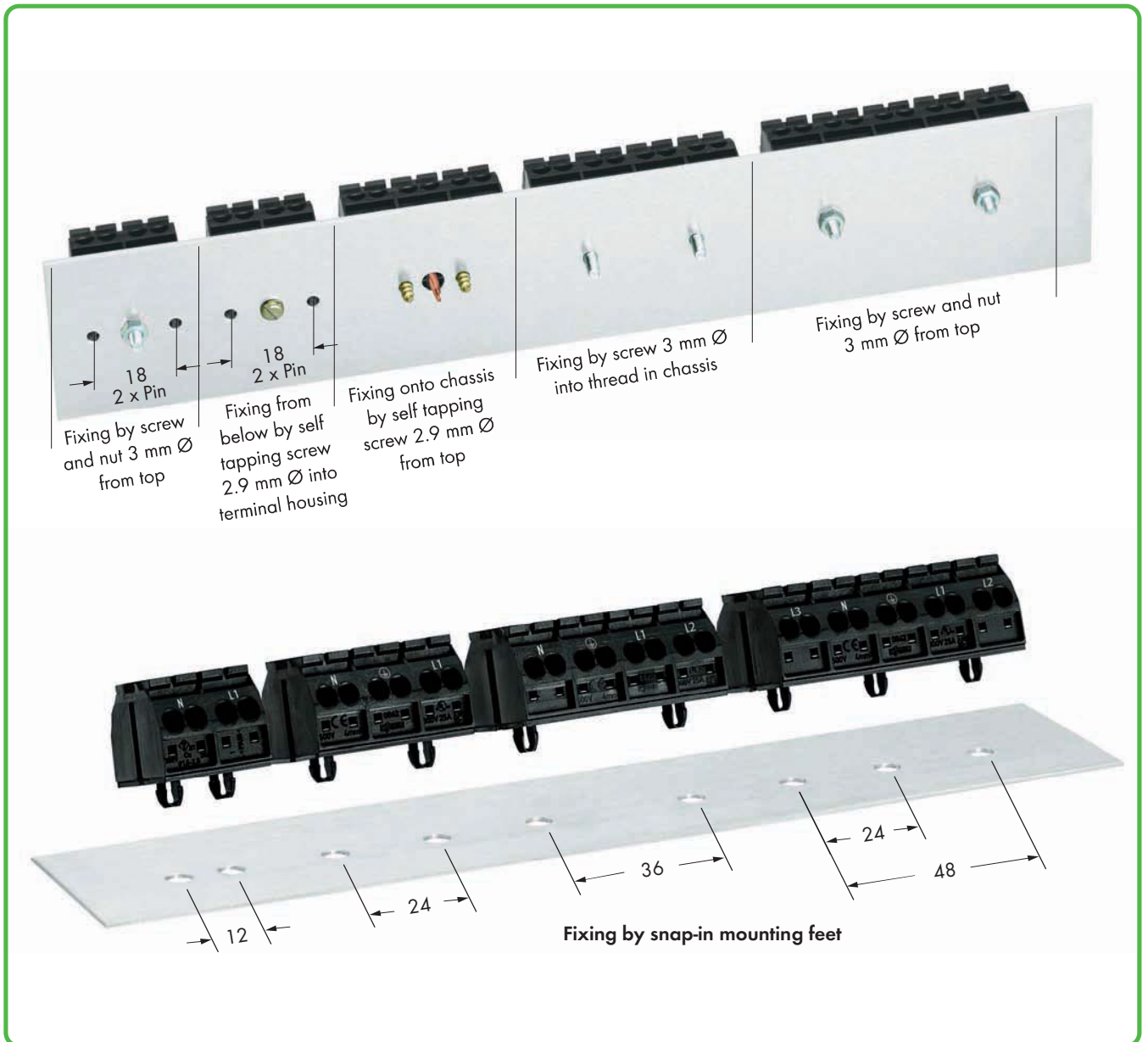

Dimensions in mm

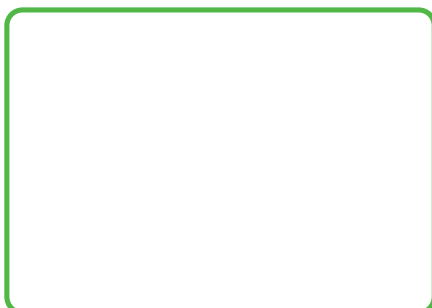

Dimensions in mm for ground contact and snap-in mounting foot 5.2 mm Ø.

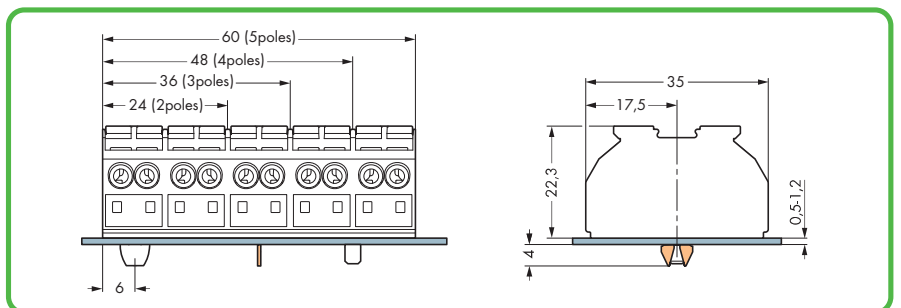



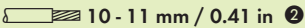
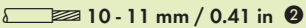

Dimensions in mm for chassis-mount terminal strips

4-Conductor, Chassis-Mount Terminal Strips, 3-Pole, 4 mm², 862 Series

0.5 - 4 mm ² 500 V/6 kV/3 ① I _N 32 A	AWG 20 - 12 300 V, 20 A ② 300 V, 20 A ③	0.5 - 4 mm ² 500 V/6 kV/3 ① I _N 32 A	AWG 20 - 12 300 V, 20 A ② 300 V, 20 A ③
 10 - 11 mm / 0.41 in ②		 10 - 11 mm / 0.41 in ②	



- ① 500 V = rated voltage
6 kV = rated surge voltage
3 = pollution degree
(also see Section 14)
- ② Strip length, see packaging or instructions.
- ③ Suitable for Ex e II applications
440 V, 28 A
(also see Section 14)

Item No.	Pack. Unit	Item No.	Pack. Unit	862 Series Accessories
for mounting via screw and nut 3 mm Ø or for self-tapping screw 2.9 mm Ø from top,		for mounting via screw and nut 3 mm Ø or for self-tapping screw 2.9 mm Ø from top,		
3-pole, black		3-pole, white		Comb-style jumper bar, simply push into the conductor entry hole I _N 32 A 862-482 5
● N-PE-L1, without PE contact	862-2503 250	○ N-PE-L1, without PE contact	862-2603 250	Test plug,  with 500 mm cable, 2 mm Ø red 210-136 50
● PE-N-L1, without PE contact	862-1503 250	○ PE-N-L1, without PE contact	862-1603 250	Test plug,  with 500 mm cable, 2.3 mm Ø yellow 210-137 50
● PE-N-L1 ③, without PE contact	862-1503/999-950 ③ 250	○ PE-N-L1 ③, without PE contact	862-1603/999-950 ③ 250	Marking strip, plain,  7.5 mm wide, 50 m roll white 709-178 1
● plain, without PE contact	862-503 250	○ plain, without PE contact	862-603 250	Operating tool with partially insulated shaft,  type 2, (3.5 x 0.5) mm blade 210-720 1
● N-PE-L1, with PE contact	862-8503 250	○ N-PE-L1, with PE contact	862-8603 250	
● PE-N-L1, with PE contact	862-9503 250	○ PE-N-L1, with PE contact	862-9603 250	
via 1 snap-in foot per pole,		via 1 snap-in foot per pole,		
3-pole, black		3-pole, white		
● N-PE-L1, without PE contact	862-2533 250	○ N-PE-L1, without PE contact	862-2633 250	
● PE-N-L1, without PE contact	862-1533 250	○ PE-N-L1, without PE contact	862-1633 250	
● PE-N-L1 ③, without PE contact	862-1533/999-950 ③ 250	○ PE-N-L1 ③, without PE contact	862-1633/999-950 ③ 250	
● plain, without PE contact	862-533 250	○ plain, without PE contact	862-633 250	
● N-PE-L1, with PE contact	862-8533 250	○ N-PE-L1, with PE contact	862-8633 250	
● PE-N-L1, with PE contact	862-9533 250	○ PE-N-L1, with PE contact	862-9633 250	
snap-in feet at pos. 1+3,		snap-in feet at pos. 1+3,		
3-pole, black		3-pole, white		
● N-PE-L1, without PE contact	862-2593 250	○ N-PE-L1, without PE contact	862-2693 250	
● PE-N-L1, without PE contact	862-1593 250	○ PE-N-L1, without PE contact	862-1693 250	
● PE-N-L1 ③, without PE contact	862-1593/999-950 ③ 250	○ PE-N-L1 ③, without PE contact	862-1693/999-950 ③ 250	
● plain, without PE contact	862-593 250	○ plain, without PE contact	862-693 250	
● N-PE-L1, with PE contact	862-8593 250	○ N-PE-L1, with PE contact	862-8693 250	
● PE-N-L1, with PE contact	862-9593 250	○ PE-N-L1, with PE contact	862-9693 250	

For list of approvals and user guide, see pages 634 to 637.