

# Modular Terminal Blocks and Terminal Strips 260 to 262 Series

## Assembly

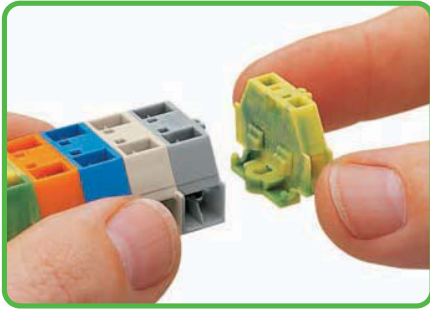

Assembling modular terminal blocks into terminal strips.



Mounting an end plate.

## Fixing

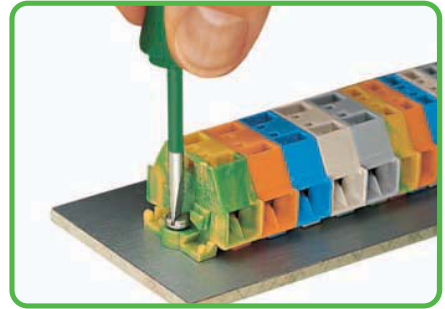

Terminal strip with fixing flanges, screw mount.

## CAGE CLAMP® connection

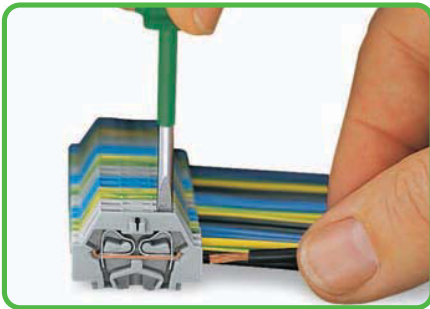

Conductor termination

## CAGE CLAMP® connection

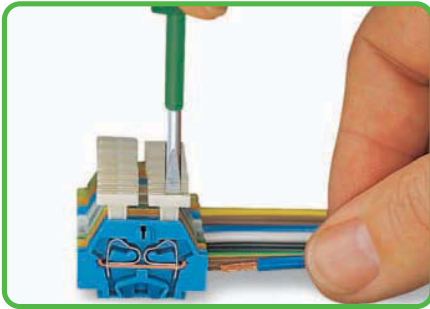

Conductor termination via push-button.

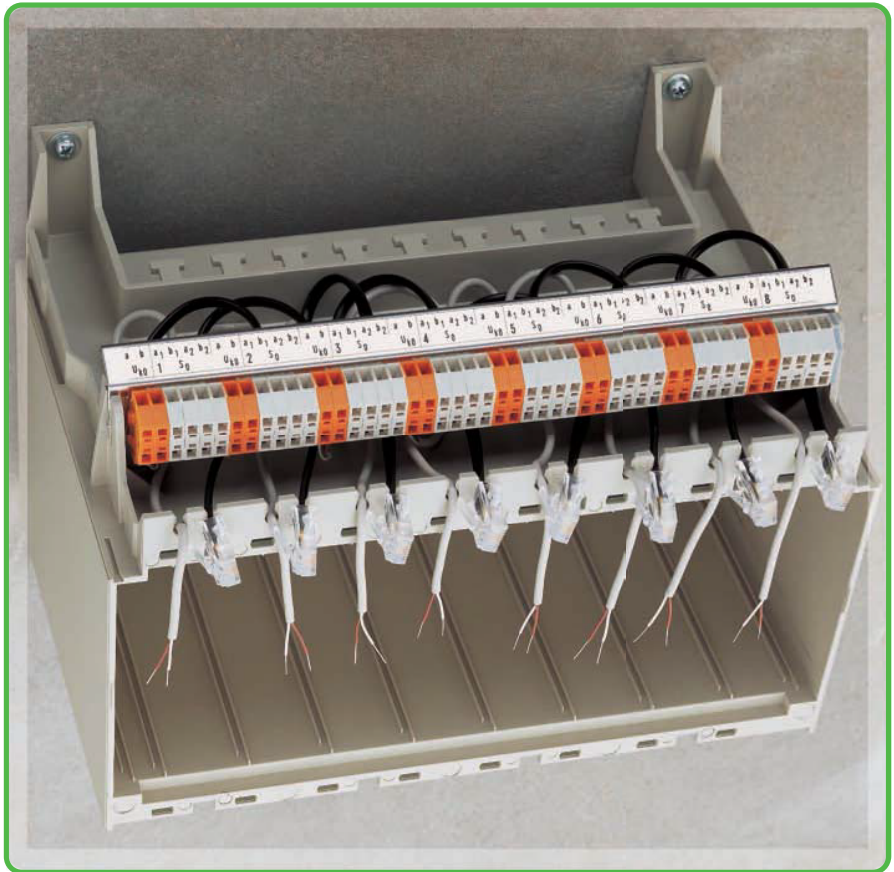

## Types

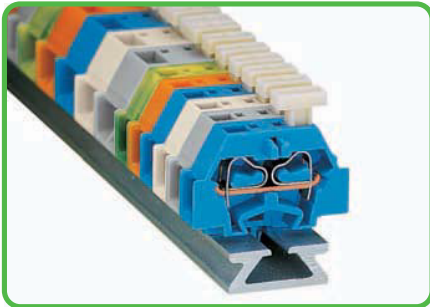

Terminal strip with push-buttons on one side.

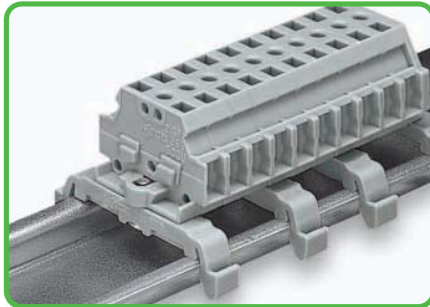

Terminal strip with marker slot for miniature WSB Quick marking system.

## Commoning

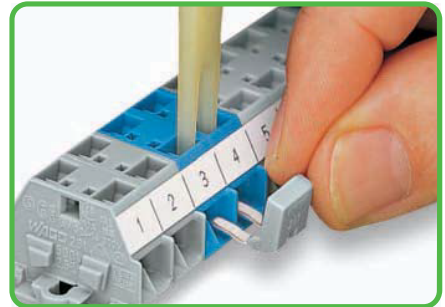

Commoning with comb-style jumper bar.

CAGE CLAMP® clamps the following copper conductors:\*

solid

stranded

fine-stranded, also with tinned single strands

\* For aluminum conductors, see notes in Section 14.

# - Description and Handling -

## Fixing



Terminal strip with snap-in mounting feet, mounting in holes.

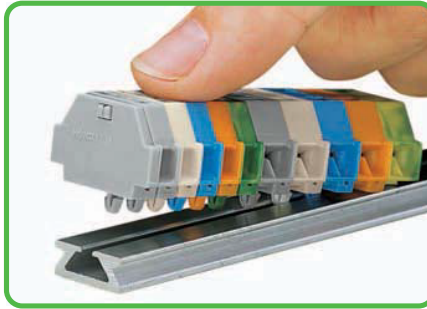

Terminal strip with snap-in mounting feet, mounting onto special aluminum rail.

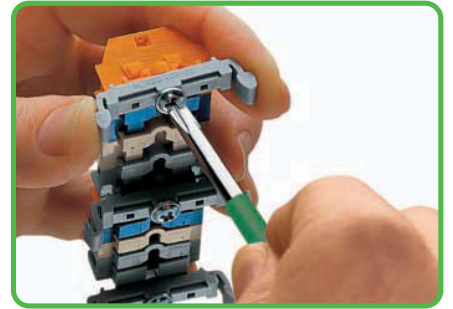

Terminal strip with fixing flanges, screw mounting of 209-123 mounting adapter (The distance between mounting adapters should be 35 - 40 mm / 1.378 - 1.575 in max.).

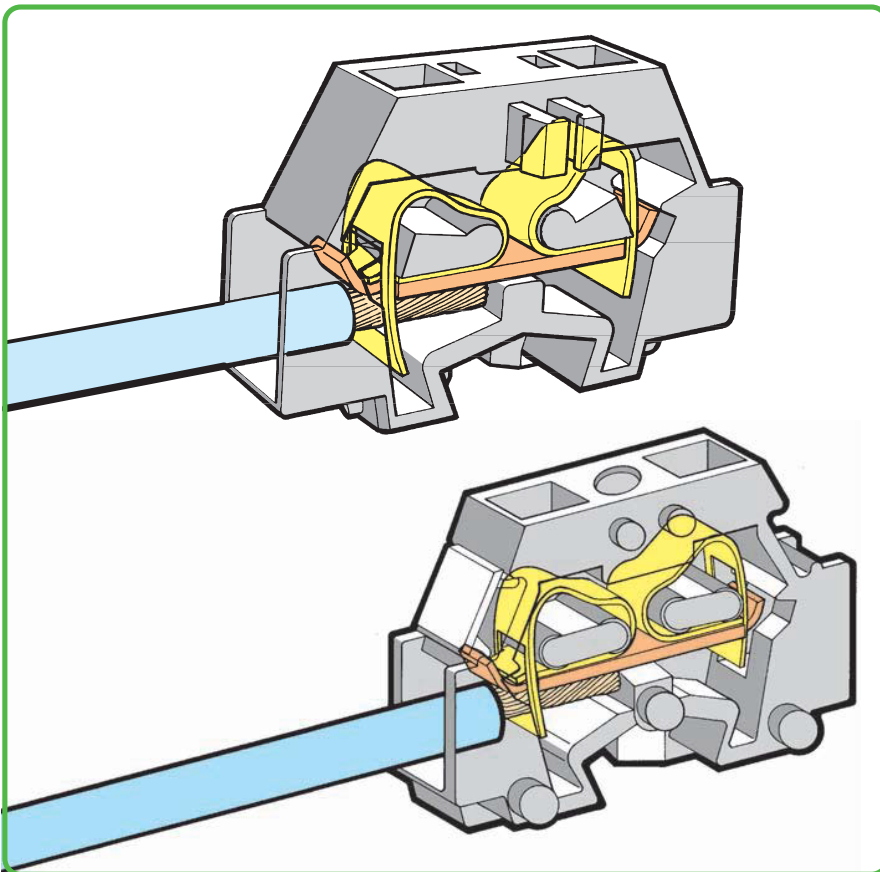

## Fixing

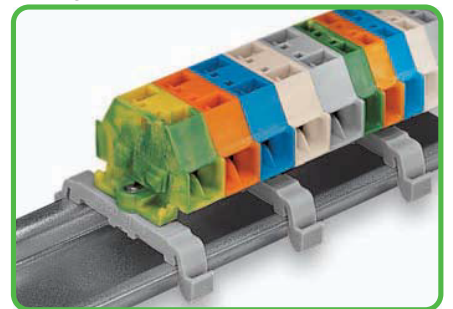

Terminal strip with fixing flanges, on DIN 35 rail.

## Fixing

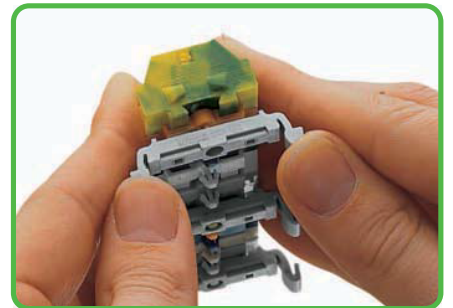

Terminal strip with snap-in mounting feet, connecting to 209-123 mounting adapter (The distance between mounting adapters should be 35 - 40 mm / 1.378 - 1.575 in max.).

## Marking



Marking with self-adhesive marker strips.

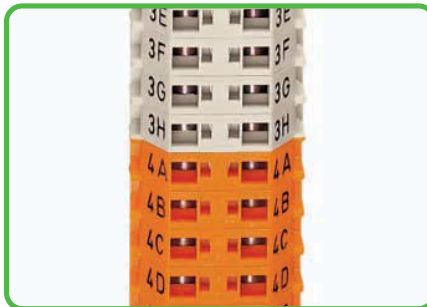

Marking by direct printing (on request).

## Fixing

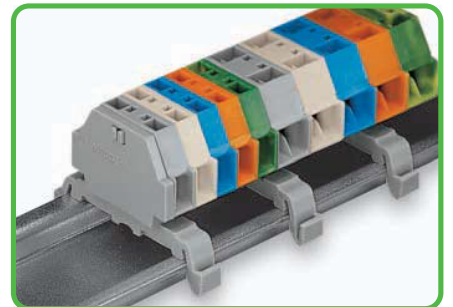

Terminal strip with snap-in mounting feet, on DIN 35 rail.



fine-stranded, tip-bonded



fine-stranded, with ferrule <sup>1</sup> (gaslight crimped)



fine-stranded, with pin terminal (gaslight crimped)

<sup>1</sup> When using ferruled conductors, it is necessary to use a terminal block one size larger than the nominal cross section of the wire.

# Terminal Strips with Push-Buttons on Both Sides, Fixing Flanges or Snap-in Mounting Feet 2.5 mm<sup>2</sup> 261 Series

0.08 - 2.5 mm <sup>2</sup>   AWG 28 - 14 500 V/6 kV/3 ① I <sub>N</sub> 24 A Pole width 6 mm / 0.236 in 8 - 9 mm / 0.33 in ②	0.08 - 2.5 mm <sup>2</sup>   AWG 28 - 14 500 V/6 kV/3 ① I <sub>N</sub> 24 A Pole width 10 mm / 0.394 in 8 - 9 mm / 0.33 in ②
---	--

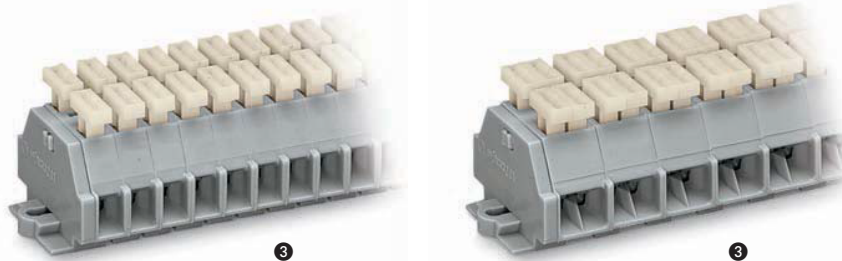

- ① 500 V = rated voltage  
6 kV = rated surge voltage  
3 = pollution degree  
(also see Section 14)
- ② Strip length, see packaging or instructions.
- ③ Terminal blocks with blue insulation are suitable for Ex i applications  
Item no. suffix .../000-006
- ④ For longer strips and/or assemblies of different colors, please contact factory

Pole No.	Item No.	Pack. Unit	Pole No.	Item No.	Pack. Unit
<b>2-conductor terminal strip with push-buttons on both sides and with fixing flanges,</b>			<b>4-conductor terminal strip with push-buttons on both sides and with fixing flanges,</b>		
gray			gray		
2	261-102/341-000	100	2	261-202/342-000	100
3	261-103/341-000	100	3	261-203/342-000	100
4	261-104/341-000	50	4	261-204/342-000	100
5	261-105/341-000	100	5	261-205/342-000	100
6	261-106/341-000	25	6	261-206/342-000	50
7	261-107/341-000	50	7	261-207/342-000	50
8	261-108/341-000	50	8	261-208/342-000	100
9	261-109/341-000	100	9	261-209/342-000	50
10	261-110/341-000	25	10	261-210/342-000	25
11	261-111/341-000	25	11	261-211/342-000	25
12 ④	261-112/341-000	25	12 ④	261-212/342-000	50
<b>2-conductor terminal strip with push-buttons on both sides and with snap-in mounting feet, gray</b>			<b>4-conductor terminal strip with push-buttons on both sides and with snap-in mounting feet, gray</b>		
2	261-152/341-000	100	2	261-252/342-000	100
3	261-153/341-000	100	3	261-253/342-000	100
4	261-154/341-000	50	4	261-254/342-000	100
5	261-155/341-000	100	5	261-255/342-000	100
6	261-156/341-000	100	6	261-256/342-000	50
7	261-157/341-000	50	7	261-257/342-000	50
8	261-158/341-000	50	8	261-258/342-000	50
9	261-159/341-000	50	9	261-259/342-000	50
10	261-160/341-000	25	10	261-260/342-000	25
11	261-161/341-000	25	11	261-261/342-000	100
12 ④	261-162/341-000	100	12 ④	261-262/342-000	25



Terminal strip with fixing flanges, for screw or similar mounting types, fixing hole 3.2 mm Ø (with 209-123 mounting adapter also for DIN 35 rail)

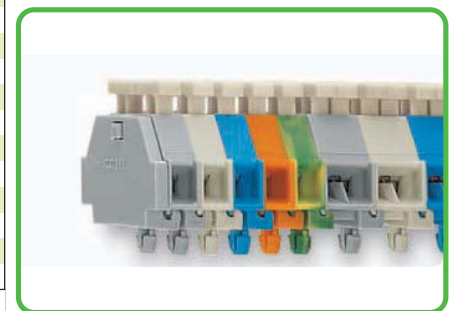

Terminal strip with snap-in mounting feet, for plate thickness 0.6 mm - 1.2 mm (0.02 in - 0.047 in), fixing hole 3.5 mm Ø (fits 210-154 aluminum rail or with 209-120 mounting adapter for DIN 35 rail)

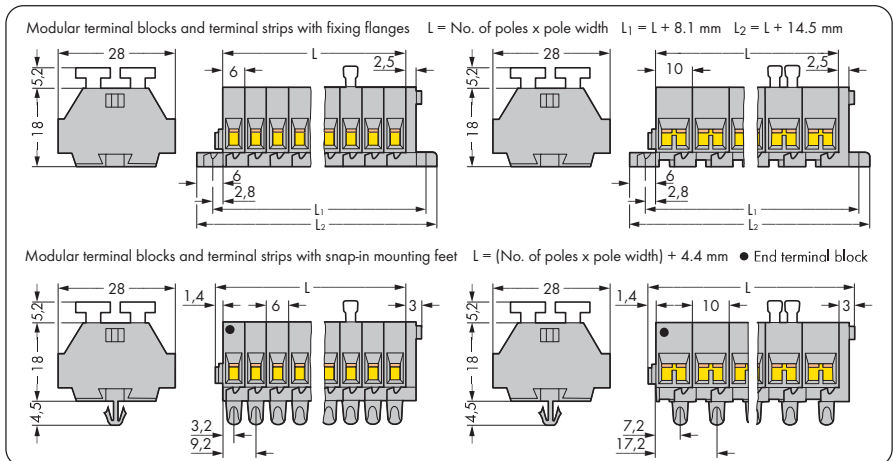

For list of approvals and user guide, see pages 634 to 637.