

Modular Terminal Blocks and Terminal Strips 260 to 262 Series

Assembly

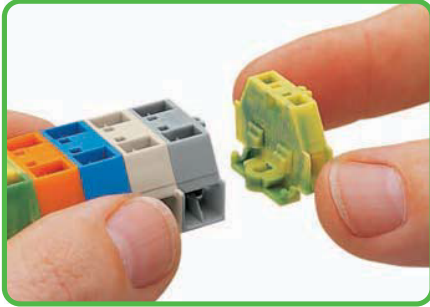

Assembling modular terminal blocks into terminal strips.

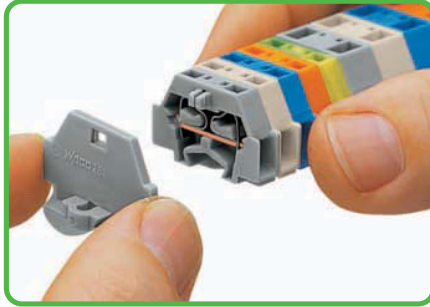

Mounting an end plate.

Fixing

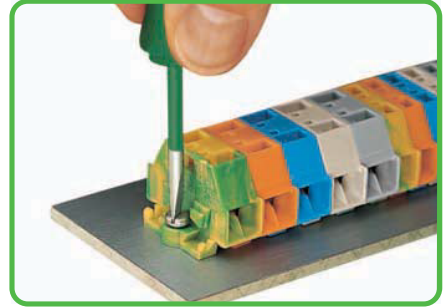

Terminal strip with fixing flanges, screw mount.

CAGE CLAMP® connection

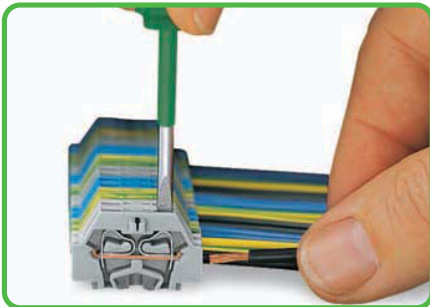

Conductor termination

CAGE CLAMP® connection

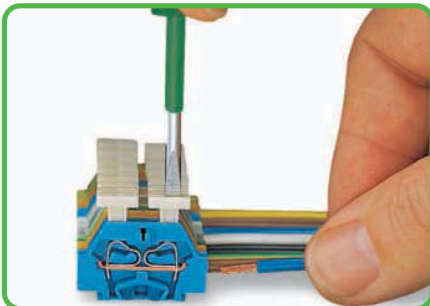

Conductor termination via push-button.

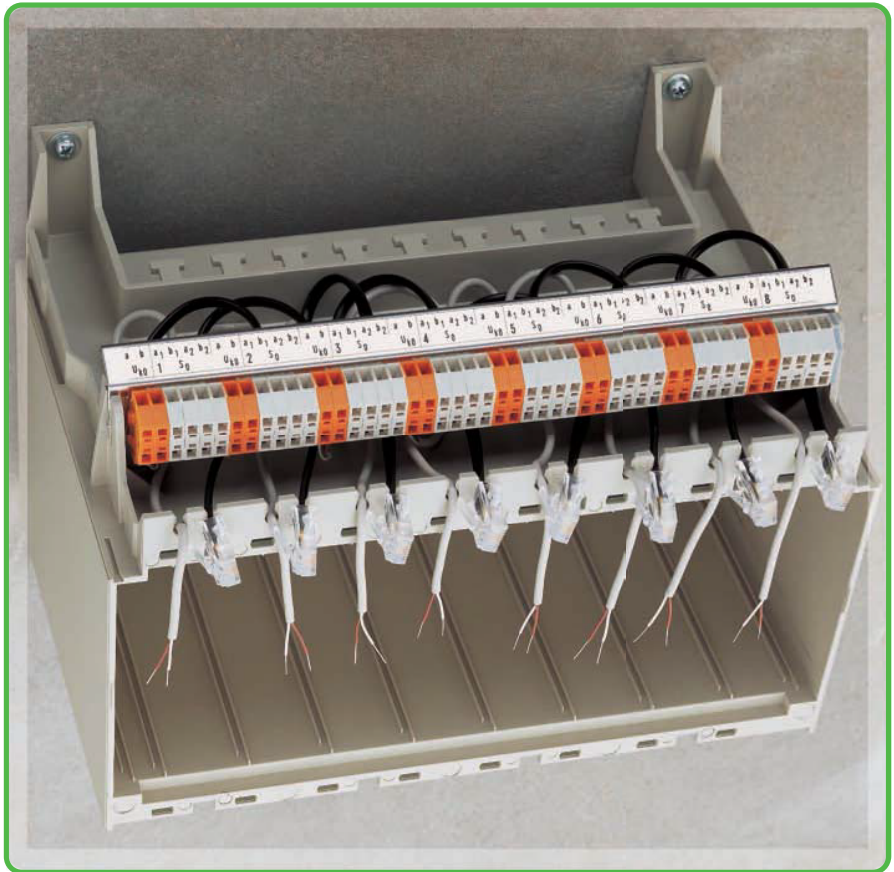

Types

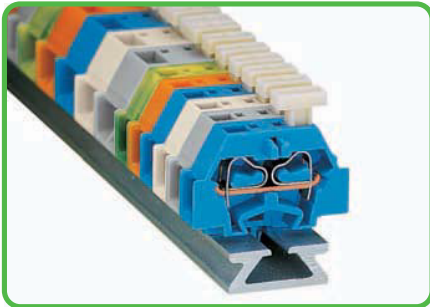

Terminal strip with push-buttons on one side.

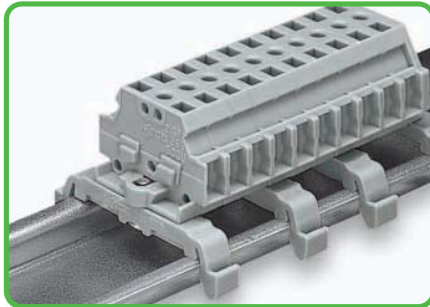

Terminal strip with marker slot for miniature WSB Quick marking system.

Commoning

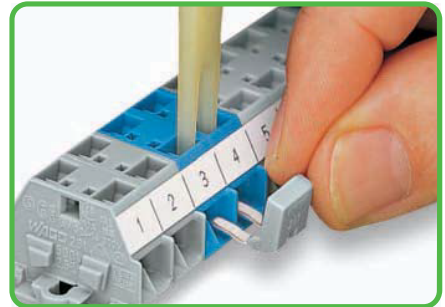

Commoning with comb-style jumper bar.

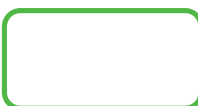

CAGE CLAMP®
clamps the following
copper conductors:*

solid

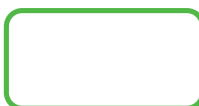

stranded

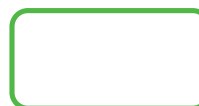

fine-stranded,
also with tinned
single strands

* For aluminum conductors, see notes in Section 14.

- Description and Handling -

Fixing



Terminal strip with snap-in mounting feet, mounting in holes.

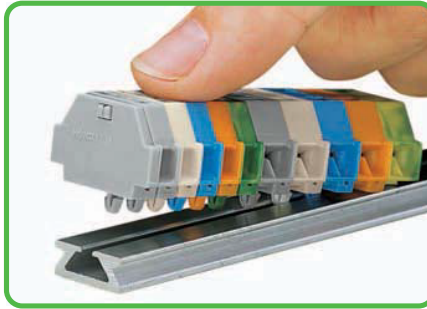

Terminal strip with snap-in mounting feet, mounting onto special aluminum rail.

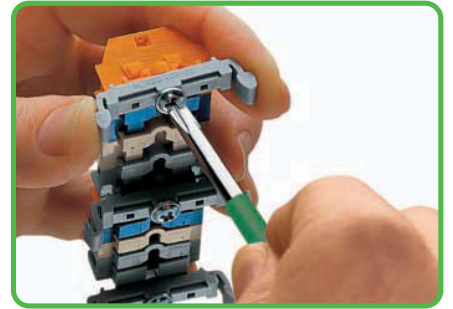

Terminal strip with fixing flanges, screw mounting of 209-123 mounting adapter (The distance between mounting adapters should be 35 - 40 mm / 1.378 - 1.575 in max.).

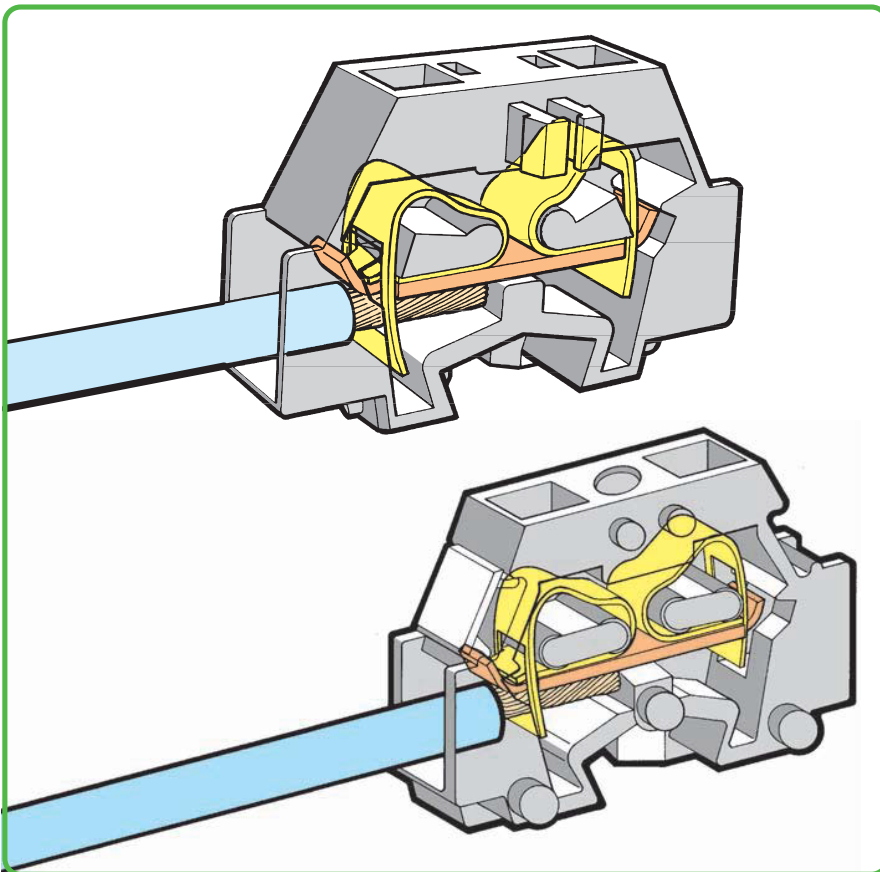

Fixing

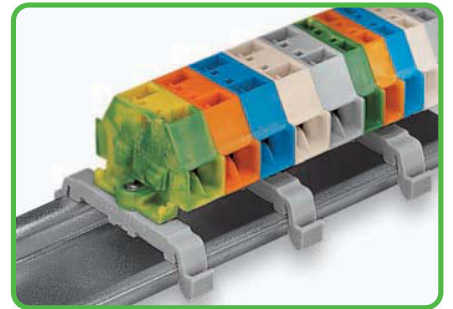

Terminal strip with fixing flanges, on DIN 35 rail.

Fixing

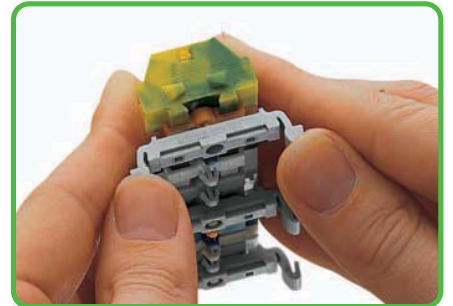

Terminal strip with snap-in mounting feet, connecting to 209-123 mounting adapter (The distance between mounting adapters should be 35 - 40 mm / 1.378 - 1.575 in max.).

Marking



Marking with self-adhesive marker strips.

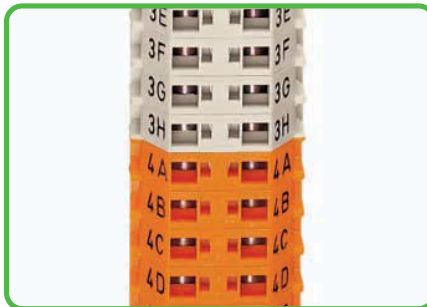

Marking by direct printing (on request).

Fixing

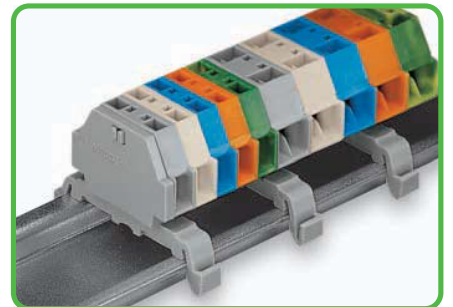

Terminal strip with snap-in mounting feet, on DIN 35 rail.



fine-stranded, tip-bonded



fine-stranded, with ferrule ① (gaslight crimped)



fine-stranded, with pin terminal (gaslight crimped)

① When using ferruled conductors, it is necessary to use a terminal block one size larger than the nominal cross section of the wire.

Terminal Strips with Push-Buttons on Both Sides, Fixing Flanges or Snap-in Mounting Feet 2.5 mm² 261 Series

0.08 - 2.5 mm ² AWG 28 - 14 500 V/6 kV/3 ① I _N 24 A Pole width 6 mm / 0.236 in 8 - 9 mm / 0.33 in ②	0.08 - 2.5 mm ² AWG 28 - 14 500 V/6 kV/3 ① I _N 24 A Pole width 10 mm / 0.394 in 8 - 9 mm / 0.33 in ②
---	--

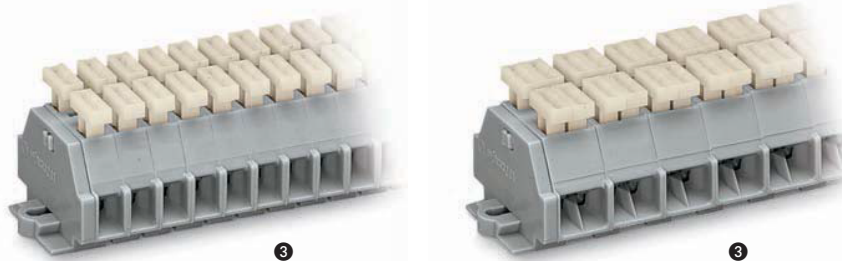

- ① 500 V = rated voltage
6 kV = rated surge voltage
3 = pollution degree
(also see Section 14)
- ② Strip length, see packaging or instructions.
- ③ Terminal blocks with blue insulation are suitable for Ex i applications
Item no. suffix .../000-006
- ④ For longer strips and/or assemblies of different colors, please contact factory

Pole No.	Item No.	Pack. Unit	Pole No.	Item No.	Pack. Unit
2-conductor terminal strip with push-buttons on both sides and with fixing flanges,			4-conductor terminal strip with push-buttons on both sides and with fixing flanges,		
gray			gray		
2	261-102/341-000	100	2	261-202/342-000	100
3	261-103/341-000	100	3	261-203/342-000	100
4	261-104/341-000	50	4	261-204/342-000	100
5	261-105/341-000	100	5	261-205/342-000	100
6	261-106/341-000	25	6	261-206/342-000	50
7	261-107/341-000	50	7	261-207/342-000	50
8	261-108/341-000	50	8	261-208/342-000	100
9	261-109/341-000	100	9	261-209/342-000	50
10	261-110/341-000	25	10	261-210/342-000	25
11	261-111/341-000	25	11	261-211/342-000	25
12 ④	261-112/341-000	25	12 ④	261-212/342-000	50
2-conductor terminal strip with push-buttons on both sides and with snap-in mounting feet, gray			4-conductor terminal strip with push-buttons on both sides and with snap-in mounting feet, gray		
2	261-152/341-000	100	2	261-252/342-000	100
3	261-153/341-000	100	3	261-253/342-000	100
4	261-154/341-000	50	4	261-254/342-000	100
5	261-155/341-000	100	5	261-255/342-000	100
6	261-156/341-000	100	6	261-256/342-000	50
7	261-157/341-000	50	7	261-257/342-000	50
8	261-158/341-000	50	8	261-258/342-000	50
9	261-159/341-000	50	9	261-259/342-000	50
10	261-160/341-000	25	10	261-260/342-000	25
11	261-161/341-000	25	11	261-261/342-000	100
12 ④	261-162/341-000	100	12 ④	261-262/342-000	25

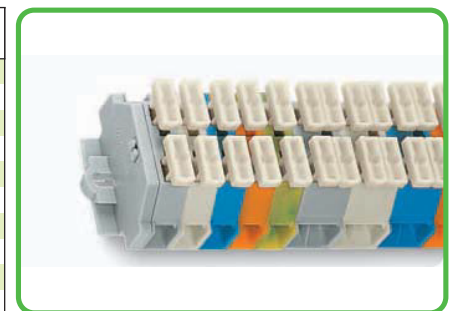

Terminal strip with fixing flanges, for screw or similar mounting types, fixing hole 3.2 mm Ø (with 209-123 mounting adapter also for DIN 35 rail)

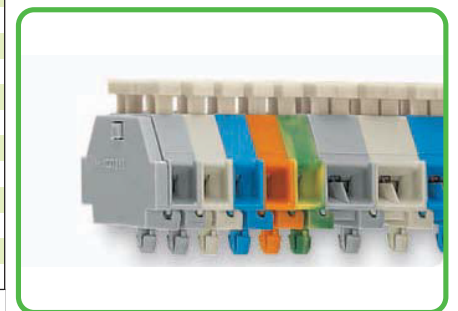

Terminal strip with snap-in mounting feet, for plate thickness 0.6 mm - 1.2 mm (0.02 in - 0.047 in), fixing hole 3.5 mm Ø (fits 210-154 aluminum rail or with 209-120 mounting adapter for DIN 35 rail)

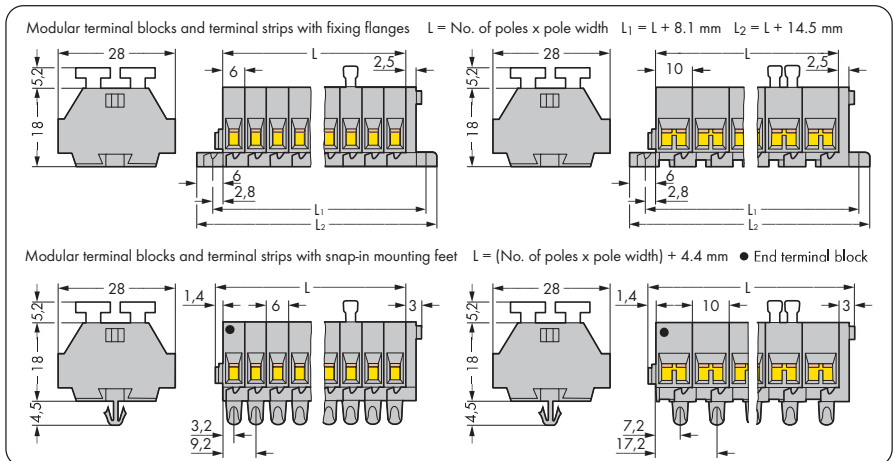

For list of approvals and user guide, see pages 634 to 637.