

# 1 CAGE CLAMP® S Rail-Mounted Terminal Blocks 2000 to 2016 Series

50

## Simply push-in



Directly insert solid and ferruled conductors.

## Conductor termination

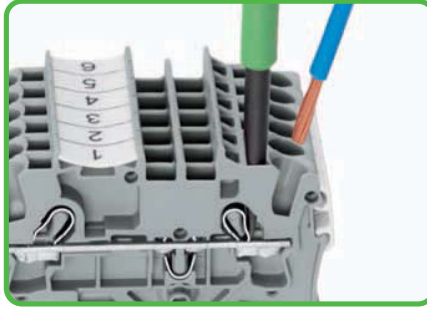

Terminating fine-stranded conductors using an operating tool.

## Insulation stop

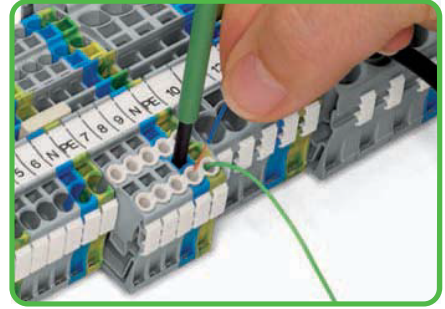

Conductor termination - Insulation stop.

## Simply jumpered



Insert push-in type jumper bar and push down firmly until it hits the backstop.

## Customizable push-in type jumper bars



Breaking off jumper contacts (up to 4 mm<sup>2</sup>/AWG 12)

## Customizable push-in type jumper bars



Marking with a felt-tip pen.

## CAGE CLAMP®S for all conductor types



## Commoning with step-down jumpers

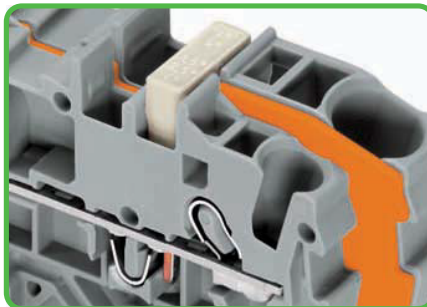

Commoning with step-down jumpers.

## Star point jumpers

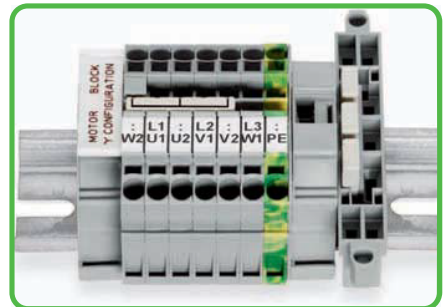

Star point jumpers designed for 'Y' configuration



CAGE CLAMP®S clamps the following copper conductors:\*

solid



stranded



fine-stranded, also with tinned single strands

\* For aluminum conductors, see notes in Section 14.

## - Description and Handling -

### Simply smaller



Up to 30% more compact. Advantage: More wiring space or smaller switch cabinets/junction boxes.

### TOPJOB®S connectors



The 2001, 2002 and 2004 Series terminal blocks are equipped with a test socket for 2 mm Ø or 2.3 mm Ø test plugs.

### Testing tap



Testing tap suited for 2001 to 2016 Series terminal blocks. Tool-free connections for individual test wires up to 2.5 mm<sup>2</sup>/AWG 12.



### Test plug adapter



The test plug adapter for 4 mm Ø plugs is suited for 2001 to 2016 Series terminal blocks.

### Simply marked



Marker strips for center marking

### Wire jumpers



Push down the wire jumper until fully inserted. Lift the jumper with an operating tool for rewiring.

### Marking



WMB In-line  
WMB markers on roll

### Marking



TOPJOB®S group marker carrier, snap-on type for jumper slot



fine-stranded,  
tip-bonded



fine-stranded,  
with ferrule,  
(gaslight crimped)



fine-stranded,  
with pin terminal  
(gaslight crimped)

# Double-Potential Terminal Blocks 1.5 (2.5) mm<sup>2</sup> 2001 Series

- ① Conductor sizes: 0.25 mm<sup>2</sup> - 2.5 mm<sup>2</sup> "s + f-st";  
Push-in conductor sizes: 0.5 mm<sup>2</sup> - 2.5 mm<sup>2</sup> "s"  
and 0.75 mm<sup>2</sup> - 1.5 mm<sup>2</sup>  
"insulated ferrule, 12 mm"
- ② 800 V = rated voltage  
8 kV = rated surge voltage  
3 = pollution degree  
(also see Section 14)
- ③ Strip length, see packaging or instructions.
- ④ Suitable for Ex i applications
- ⑤ Suitable for Ex e II applications  
550 V, 17 A  
Jumper 16 A  
(also see Section 14)
- ⑥ See application notes for:  
Ex e/Ex i separator plate, page 52  
Step-down jumper, page 67  
Star point jumper, page 140  
Delta jumper, page 140  
Push-in type wire jumper, page 140  
Banana plug, page 198  
TOPJOB®S connector, page 134

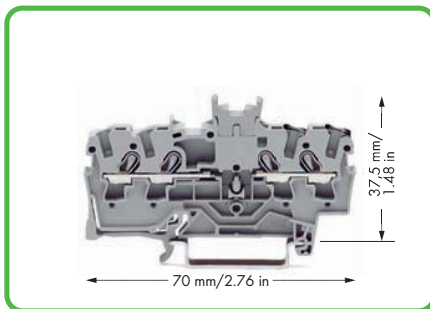

Double-potential terminal block with double marker slot centered on terminal block  
gray 2001-1441  
Packing unit: 100 pcs

















**Notice: This double-potential terminal block cannot be commoned with push-in type jumper bars!**

Double-potential terminal blocks are space savers. Two independent feedthrough circuits are placed in one insulated housing on one level in just 4.2 mm/0.165 in. This achieves a width of just 2.1 mm/0.083 in versus standard through terminal blocks. Input and output contacts of one circuit are placed on the same side of the terminal block. Both circuits can be individually marked according to input and output.

For technical data and accessories, see [www.wagocatalog.com](http://www.wagocatalog.com)

## 2001 Series Accessories

Appropriate marking systems: WMB/Marking strips  
(see Section 13)

<b>Delta jumper, insulated,</b>  ⑥ I <sub>N</sub> = I <sub>N</sub> terminal block, light gray 1-2 3-4 5-6 <b>2001-406/020-000</b> 100 (4x25)	<b>WMB Inline, plain,</b>  stretchable 4 - 4.2 mm, 2,000 WMB markers, 4 mm, on roll white <b>2009-114</b> 1
<b>Star point jumper, insulated,</b>  ⑥ I <sub>N</sub> = I <sub>N</sub> terminal block, light gray 1-3-5 <b>2001-405/011-000</b> 100 (4x25)	<b>WMB Multi marking system,</b>  10 strips with 10 markers per card, stretchable 4 - 4.2 mm plain <b>793-4501</b> 5
<b>Push-in type wire jumper,</b>  ⑥ insulated, I <sub>N</sub> 16 A, wire size 1.5 mm <sup>2</sup> L = 60 mm <b>2009-412</b> 100 (10x10) L = 110 mm <b>2009-414</b> 100 (10x10) L = 250 mm <b>2009-416</b> 100 (10x10)	<b>WMB Multi marking system, plain,</b>  10 strips with 10 markers per card, stretchable 4 - 4.2 mm yellow <b>793-4501/000-002</b> red <b>793-4501/000-005</b> blue <b>793-4501/000-006</b> gray <b>793-4501/000-007</b> orange <b>793-4501/000-012</b> light green <b>793-4501/000-017</b> green <b>793-4501/000-023</b> violet <b>793-4501/000-024</b> 5
<b>Modular TOPJOB®S connector,</b>  ⑥ can be snapped together, for jumper contact slot gray <b>2001-511</b> 100 (4x25)	
<b>Spacer module, can be snapped together,</b>  e.g., for bridging commoned terminal blocks gray <b>2001-549</b> 100 (4x25)	<b>Marking strip, plain,</b>  11 mm wide, 50 m roll white <b>2009-110</b> 1
<b>End plate,</b>  for modular TOPJOB®S connectors, 1.5 mm thick gray <b>2002-541</b> 100 (4x25)	<b>Screwless end stop,</b>  for DIN 35 rail, 6 mm wide gray <b>249-116</b> 100 (4x25)
<b>Test plug adapter,</b>  for test plug 4 mm Ø gray <b>2009-174</b> 100 (4x25)	<b>Screwless end stop,</b>  for DIN 35 rail, 10 mm wide gray <b>249-117</b> 50 (2x25)
<b>Banana plug,</b>  ⑥ for socket 4 mm Ø, color mixed <b>215-111</b> 50	
<b>Testing tap,</b>  for max. 2.5 mm <sup>2</sup> gray <b>2009-182</b> 100 (4x25)	
<b>Test plug,</b>  with 500 mm cable, 2 mm Ø red <b>210-136</b> 50	
<b>Test plug,</b>  with 500 mm cable, 2.3 mm Ø yellow <b>210-137</b> 50	