

# Rail-Mounted Terminal Blocks, Side-Entry 279 to 284 Series

## Assembly

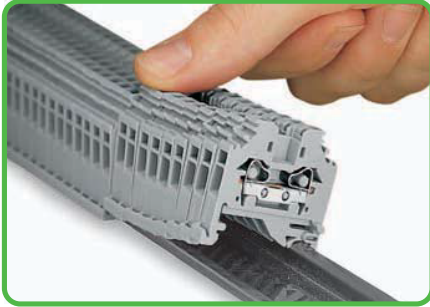

Snapping side-entry rail-mounted terminal blocks onto the carrier rail.

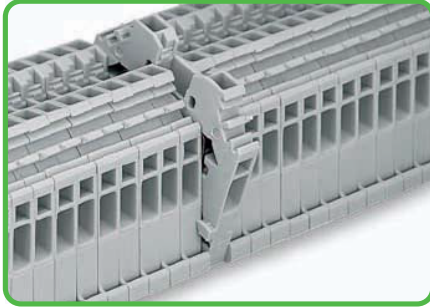

Quick assembly keys prevent reverse mounting.

## Removal



Removal from the carrier rail.

## CAGE CLAMP® connection

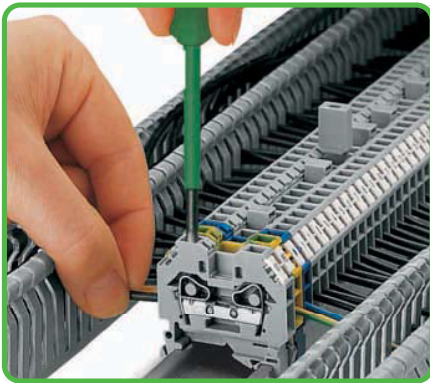

Conductor termination

## Testing

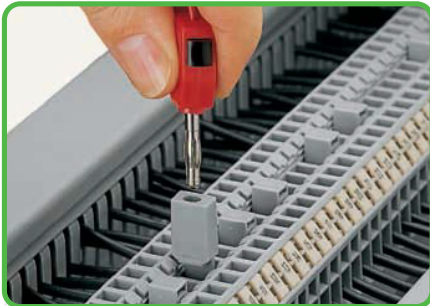

Testing with test plug adapter.

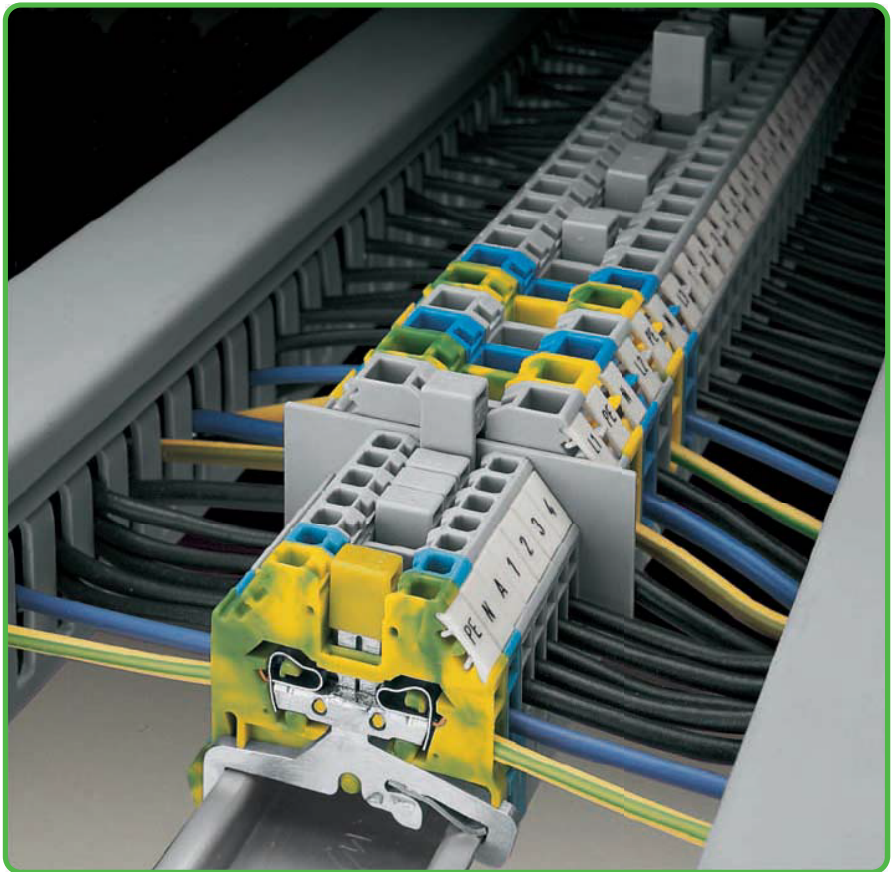

## Commoning

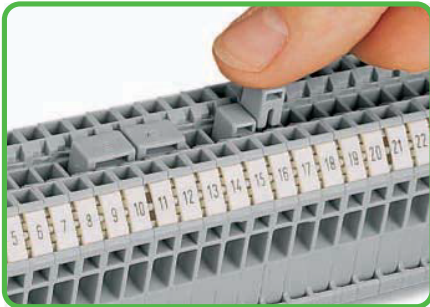

Commoning with adjacent jumpers.

## Commoning with step-down jumpers

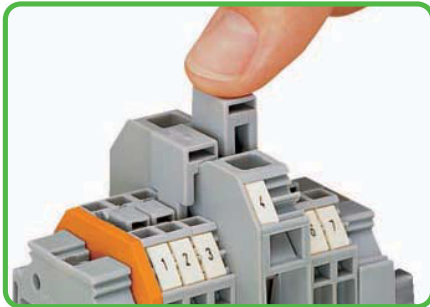

Commoning side-entry rail-mounted terminal blocks with step-down jumpers.



CAGE CLAMP® clamps the following copper conductors:\*

solid



stranded



fine-stranded, also with tinned single strands

\* For aluminum conductors, see notes in Section 14.

- Description and Handling -



Suitable for all DIN 35 rails.

Fuse terminal blocks

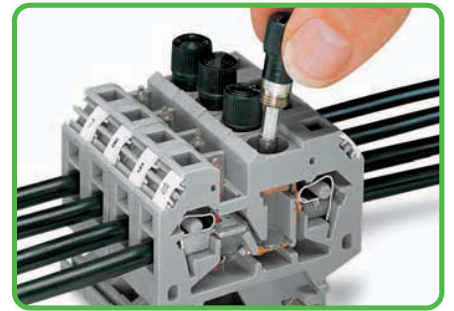

Replacing a fuse.

Disconnect terminal blocks for test and measurement

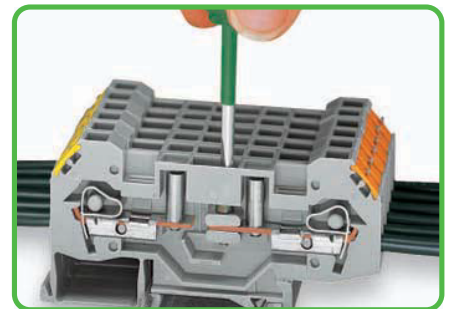

Shifting the disconnect slide link.

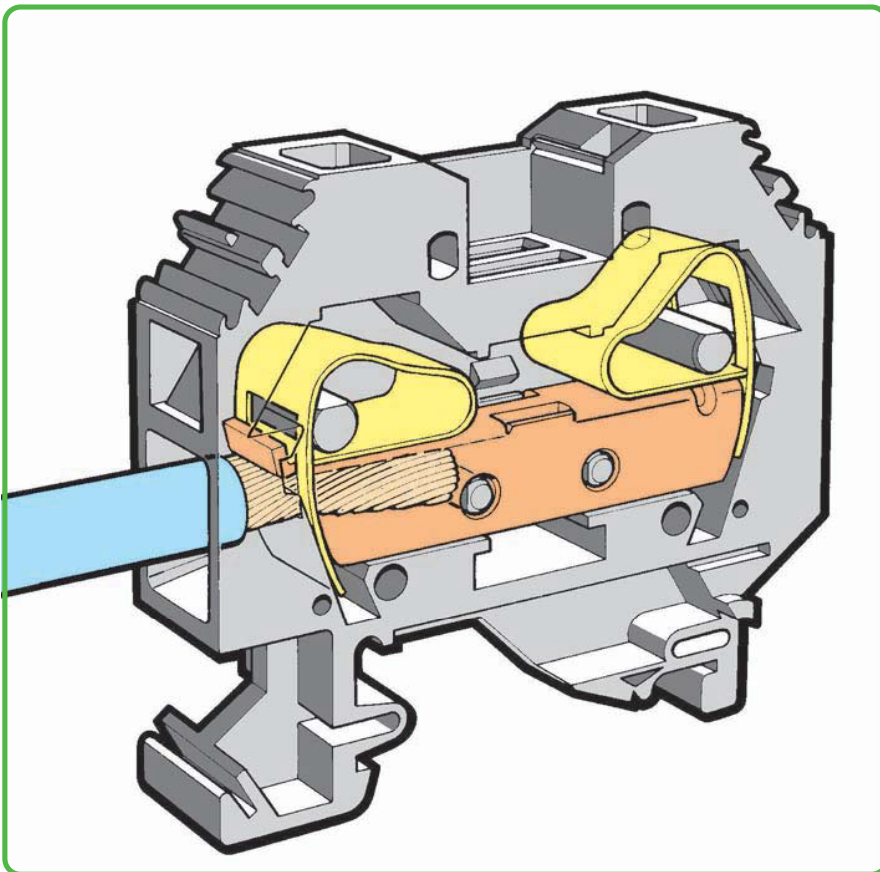

Marking



Marking with WMB Multi marking system.

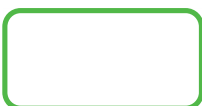

fine-stranded, tip-bonded

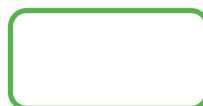

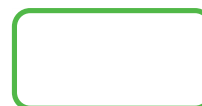

fine-stranded, with ferrule ❶ (gaslight crimped)









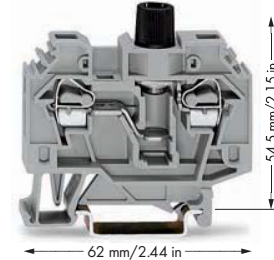
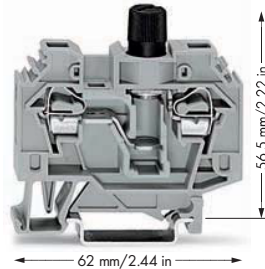
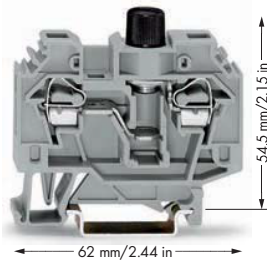





fine-stranded, with pin terminal (gaslight crimped)

❶ When using ferruled conductors, it is necessary to use a terminal block one size larger than the nominal cross section of the wire.

|                                                                                                                                                   |                                               |                                                                                                                                                   |                              |                                                                                                                                                     |                                               |
|---------------------------------------------------------------------------------------------------------------------------------------------------|-----------------------------------------------|---------------------------------------------------------------------------------------------------------------------------------------------------|------------------------------|-----------------------------------------------------------------------------------------------------------------------------------------------------|-----------------------------------------------|
| 0.2 - 6 mm <sup>2</sup><br>500 V/6 kV/3 ①<br>I <sub>N</sub> 10 A                                                                                  | AWG 24 - 10<br>600 V, 10 A ②<br>250 V, 10 A ③ | 0.2 - 6 mm <sup>2</sup><br>500 V/6 kV/3 ①<br>I <sub>N</sub> 10 A                                                                                  | AWG 24 - 10<br>250 V, 10 A ③ | 0.2 - 6 mm <sup>2</sup><br>500 V/6 kV/3 ①<br>I <sub>N</sub> 10 A                                                                                    | AWG 24 - 10<br>600 V, 10 A ②<br>250 V, 10 A ③ |
| Terminal block width 13 mm / 0.512 in<br> 12 - 13 mm / 0.49 in ② |                                               | Terminal block width 13 mm / 0.512 in<br> 12 - 13 mm / 0.49 in ② |                              | Terminal block width 13 mm / 0.512 in<br> 12 - 13 mm / 0.49 in ② |                                               |



| Item No.                                                                                                                                                                                                             | Pack. Unit        | Item No.                                                                                                                                                                                                                            | Pack. Unit        | Item No.                                                                                                                                                                                                          | Pack. Unit        |
|----------------------------------------------------------------------------------------------------------------------------------------------------------------------------------------------------------------------|-------------------|-------------------------------------------------------------------------------------------------------------------------------------------------------------------------------------------------------------------------------------|-------------------|-------------------------------------------------------------------------------------------------------------------------------------------------------------------------------------------------------------------|-------------------|
| <b>2-conductor fuse terminal block</b> , without indicator, for miniature metric fuses 5 x 20 mm                                                                                                                     |                   | <b>2-conductor fuse terminal block</b> , without indicator, for miniature metric fuses ¼" x 1"                                                                                                                                      |                   | <b>2-conductor fuse terminal block</b> , with indicator, for miniature metric fuses                                                                                                                               |                   |
| ● gray                                                                                                                                                                                                               | <b>282-122</b> 40 | ● gray                                                                                                                                                                                                                              | <b>282-120</b> 40 | ● gray                                                                                                                                                                                                            | <b>282-126</b> 40 |
| <b>2-conductor fuse terminal block</b> , without indicator, for miniature metric fuses ¼" x 1¼"                                                                                                                      |                   |                                                                                                                                                                                                                                     |                   |                                                                                                                                                                                                                   |                   |
|                                                                                                                                                                                                                      | ● gray            | <b>282-128</b> 40                                                                                                                                                                                                                   |                   |                                                                                                                                                                                                                   |                   |
| <b>Item-Specific Accessories</b>                                                                                                                                                                                     |                   | <b>Item-Specific Accessories</b>                                                                                                                                                                                                    |                   | <b>Item-Specific Accessories</b>                                                                                                                                                                                  |                   |
| <b>Miniature metric fuse</b> , 5 x 20 mm, without indicator, 6.3 A/250 V, medium/slow<br> <b>282-451</b> 200 (20x10)              |                   | <b>Miniature metric fuse</b> , ¼" x 1", without indicator, 10 A/240 V, to BS 1362<br> <b>282-458</b> 200 (20x10)                                 |                   | <b>Miniature metric fuse</b> , 5 x 25 mm/0.197 x 0.975 in, with indicator, 6.3 A, medium/slow<br> <b>282-452</b> 200 (20x10) |                   |
|                                                                                                                                                                                                                      |                   | <b>Miniature metric fuse</b> , ¼" x 1¼", without indicator, 10 A/250 V, medium/slow<br> <b>282-457</b> 200 (2x100)                               |                   | <b>Miniature metric fuse</b> , 5 x 25 mm/0.197 x 0.975 in, with indicator, 10 A, fast acting<br> <b>282-453</b> 200 (20x10)  |                   |
|                                                                                                                                                                                                                      |                   | <b>Miniature metric fuse</b> , ¼" x 1¼", without indicator, 10 A/500 V, very fast acting<br> <b>282-454</b> 200 (20x10)                          |                   |                                                                                                                                                                                                                   |                   |
| <b>Accessories for Fuse Terminal Blocks</b>                                                                                                                                                                          |                   |                                                                                                                                                                                                                                     |                   |                                                                                                                                                                                                                   |                   |
| Appropriate marking system:<br>WMB (see Section 13)                                                                                                                                                                  |                   |                                                                                                                                                                                                                                     |                   |                                                                                                                                                                                                                   |                   |
| <b>End and intermediate plate</b> , 4 mm thick<br>orange <b>282-312</b> 50 (2x25)<br>gray <b>282-311</b> 50 (2x25)<br>            |                   | <b>Test plug adapter</b> , 8.3 mm wide, for terminal blocks 1.5 - 10 mm <sup>2</sup> , for test plug 4 mm Ø<br>gray <b>209-170</b> 50 (2x25)<br> |                   |                                                                                                                                                                                                                   |                   |
| <b>Adjacent jumper</b> , insulated, I <sub>N</sub> 41 A<br>gray <b>282-402</b> 100 (4x25)<br>                                     |                   | <b>Test plug adapter</b> , 6 mm wide, with CAGE CLAMP®, for 0.08 - 2.5 mm <sup>2</sup><br>I <sub>N</sub> 24 A <b>281-407</b> 100 (4x25)<br>      |                   |                                                                                                                                                                                                                   |                   |
| <b>Protective warning marker</b> , with high-voltage symbol, black, for 5 terminal blocks<br>yellow <b>282-405</b> 100 (4x25)<br> |                   | <b>Plunger</b> , for 281, 282, 283 and 284 Series rail-mounted terminal blocks for side-entry<br><b>210-141</b> 1<br>                            |                   |                                                                                                                                                                                                                   |                   |