

# Double- and Triple-Deck Terminal Blocks, 280 and 281 Series – Description and Handling –

## Assembly

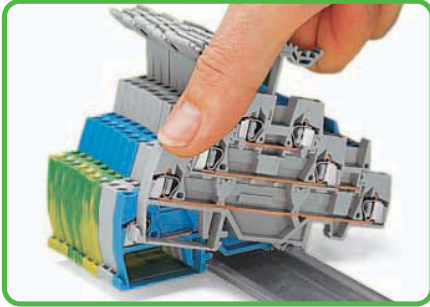

Snapping a terminal block onto the carrier rail.

## Removal

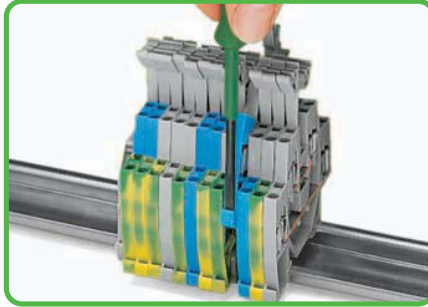

Removing a terminal block from the assembly.

## Conductor termination

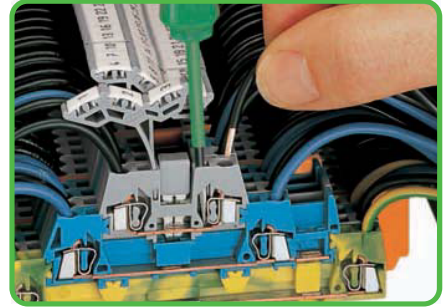

Conductor termination

## Commoning

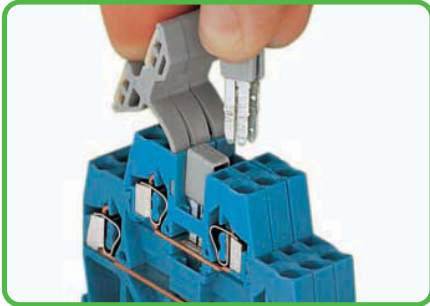

Commoning with 280-402 adjacent jumpers. Push down the adjacent jumper until fully inserted.

## Commoning

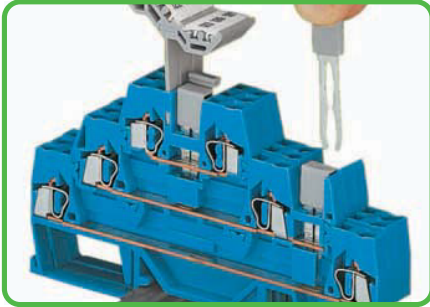

Commoning with vertical and adjacent jumpers.

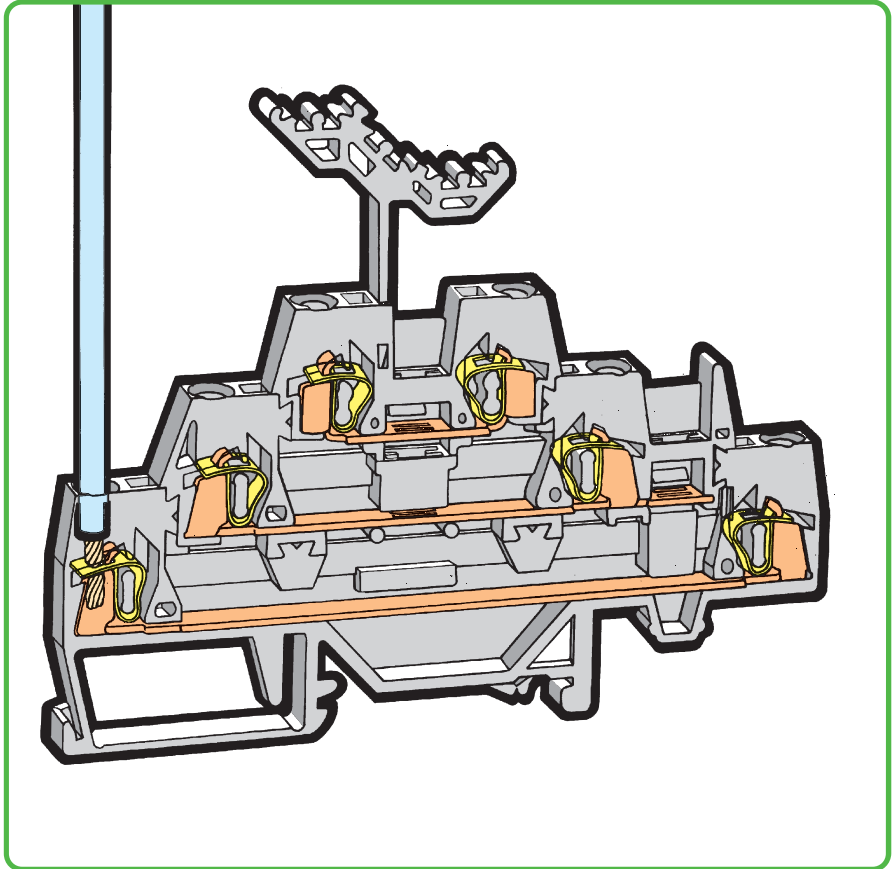

## Marking

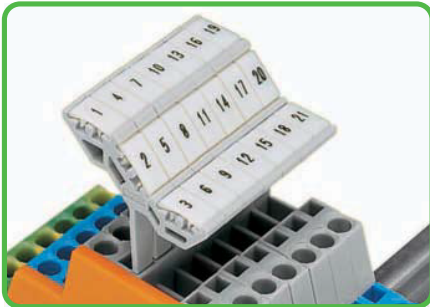

Marking with WMB Multi marking system. For other systems, see Section 13.

## Space saver

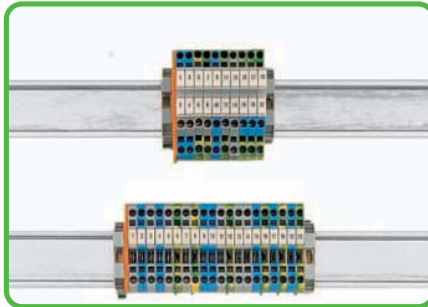

Save 50% of rail space when using double-deck terminal blocks.

## Space saver

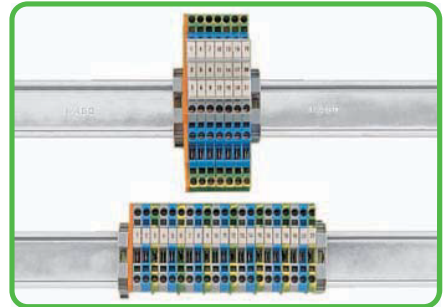

Save 67% of rail space when using triple-deck terminal blocks.

### CAGE CLAMP® clamps the following copper conductors:\*

- solid
- stranded

fine-stranded, also with tinned single strands

fine-stranded, tip-bonded

fine-stranded, with ferrule ① (gastight crimped)

fine-stranded, with pin terminal (gastight crimped)

\* For aluminum conductors, see notes in Section 14.

① When using ferrules, the max. conductor cross section accommodated is one size smaller than max. rating of terminal block.



The flexible marker carrier, which is placed above the wiring level, can be pushed aside during wiring or commoning. The marker carrier has two levels for two different markers relating to double-deck terminal blocks.

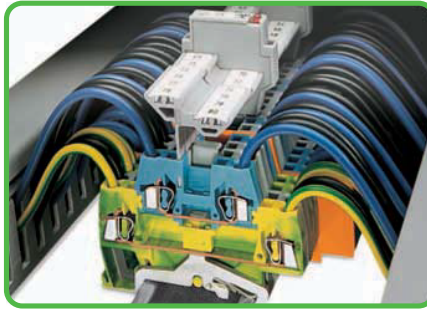

Example of a mixed assembly with double-deck terminal blocks. The 280 Series double-deck terminal blocks, are available with decks of same or different color according to the function. This is an additional visual aid during wiring or possible service/maintenance.

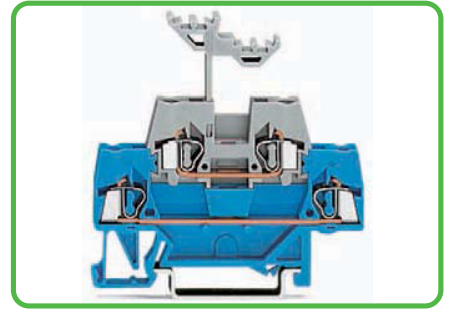

Double-deck terminal blocks accommodate two circuits of different potentials in one 2-level terminal block; different circuits can be differentiated by color coding either level for the 280 Series. The lower deck is wider than the upper, for ease of wiring.

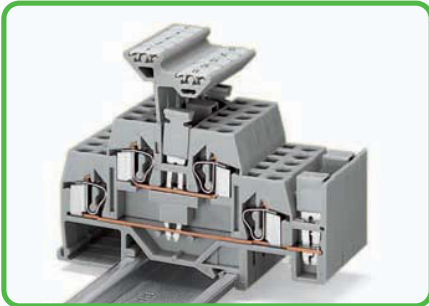

Standard insulated push-in jumpers can be used for commoning. A vertical jumper allows commoning of upper and lower level, providing a 4-conductor feedthrough terminal block in one housing. Two adjacent terminals may be commoned together on the same level using a push-in adjacent jumper.

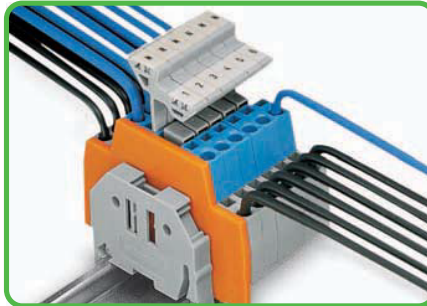

Double-deck terminal blocks used as control wire terminals; e.g., for magnetic valves. Upper deck commoned.

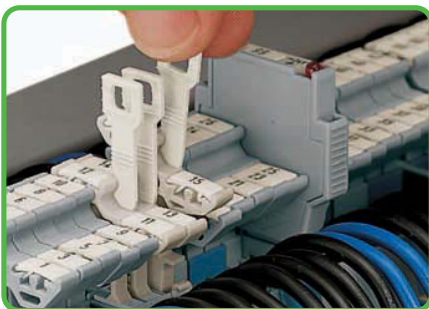

Pulling of disconnecting tab (also see page 207).

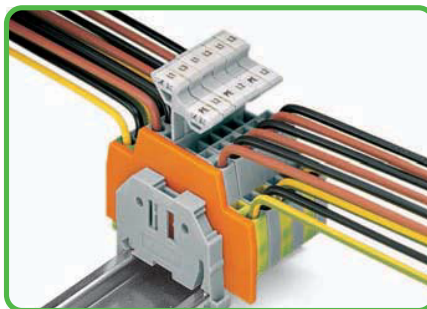

Double-deck terminal blocks used for connecting a three-phase motor.

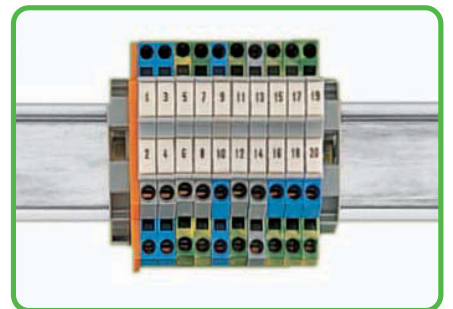

With a terminal block width of only 5 mm/0.197 in, an effective width of only 2.5 mm/0.098 in for terminal blocks of same or different potential can be realized at a cross sectional area of 0.08 mm<sup>2</sup> to 2.5 mm<sup>2</sup> (AWG 28 - 14)!

# Double-Deck Terminal Blocks 2.5 mm<sup>2</sup> 280 Series

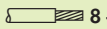
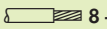
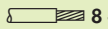
0.08 - 2.5 mm <sup>2</sup> 500 V/6 kV/3 ① I <sub>N</sub> 20 A	AWG 28 - 12 * 300 V, 15 A ② 300 V, 20 A ③	0.08 - 2.5 mm <sup>2</sup> 500 V/6 kV/3 ① I <sub>N</sub> 20 A	AWG 28 - 12 * 300 V, 15 A ② 300 V, 20 A ③	0.08 - 2.5 mm <sup>2</sup> 500 V/6 kV/3 ① I <sub>N</sub> 20 A	AWG 28 - 12 * 300 V, 20 A ③
Terminal block width 5 mm / 0.197 in  8 - 9 mm / 0.33 in ②		Terminal block width 5 mm / 0.197 in  8 - 9 mm / 0.33 in ②		Terminal block width 5 mm / 0.197 in  8 - 9 mm / 0.33 in ②	

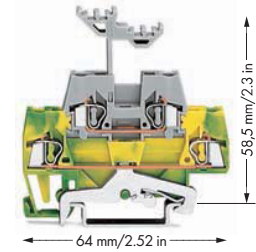
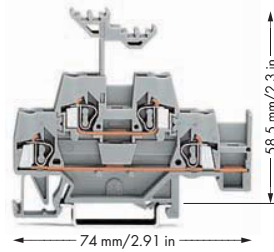
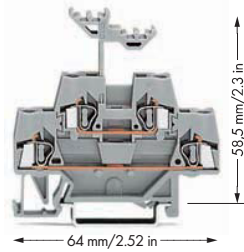

Item No.	Pack. Unit	Item No.	Pack. Unit	Item No.	Pack. Unit
<b>Through/through terminal block</b>		<b>Through/through terminal block with horizontal jumpering on lower level</b>		<b>Ground conductor/through terminal block</b>	
gray 280-519	50	gray 280-520	50	green-yellow/gray 280-527	50
blue 280-529 ③	50	blue 280-530 ③	50	green-yellow/blue 280-537	50
<b>Other terminal blocks with the same profile:</b>					
Diode 280-940/281-410 Page 260					
LED 280-943/281-434 Page 260					
<b>Item-Specific Accessories</b>		<b>Item-Specific Accessories</b>		<b>Item-Specific Accessories</b>	
<b>End and intermediate plate, 2.5 mm thick</b>		<b>End and intermediate plate, 2.5 mm thick</b>		<b>End and intermediate plate, 2.5 mm thick</b>	
orange 280-341	100 (4x25)	orange 280-343	100 (4x25)	orange 280-341	100 (4x25)
gray 280-340	100 (4x25)	gray 280-342	100 (4x25)	gray 280-340	100 (4x25)
<b>Intermediate plate, 1.1 mm thick</b>		<b>Intermediate plate, 1.1 mm thick</b>		<b>Intermediate plate, 1.1 mm thick</b>	
orange 280-366	100 (4x25)	orange 280-369	100 (4x25)	orange 280-366	100 (4x25)

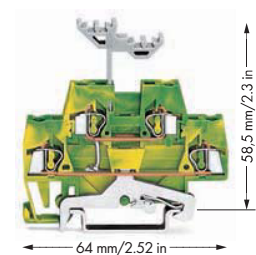
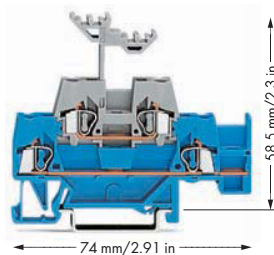
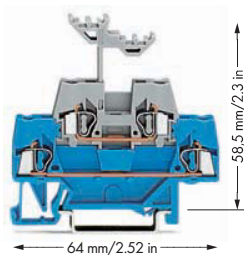

Item No.	Pack. Unit	Item No.	Pack. Unit	Item No.	Pack. Unit
<b>Through/through terminal block</b>		<b>Through/through terminal block with horizontal jumpering on lower level</b>		<b>4-conductor ground terminal block, internal commoning</b>	
blue/gray 280-523	50	blue/gray 280-524	50	green-yellow 280-517	50
gray/blue 280-533	50	gray/blue 280-534	50		
<b>Item-Specific Accessories</b>					
<b>End and intermediate plate, 2.5 mm thick</b>		<b>End and intermediate plate, 2.5 mm thick</b>		<b>End and intermediate plate, 2.5 mm thick</b>	
orange 280-341	100 (4x25)	orange 280-343	100 (4x25)	orange 280-341	100 (4x25)
gray 280-340	100 (4x25)	gray 280-342	100 (4x25)	gray 280-340	100 (4x25)
<b>Intermediate plate, 1.1 mm thick</b>		<b>Intermediate plate, 1.1 mm thick</b>		<b>Intermediate plate, 1.1 mm thick</b>	
orange 280-366	100 (4x25)	orange 280-369	100 (4x25)	orange 280-366	100 (4x25)

For list of approvals and user guide, see pages 634 to 637.