

Rail-Mounted Terminal Blocks 279 to 285 Series and 880 Series

Assembly

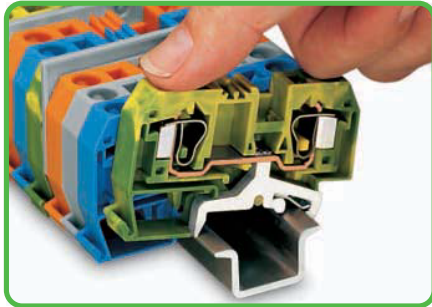

By snapping a ground conductor terminal block onto the carrier rail, a direct electrical connection is automatically made to the rail.

Assembly

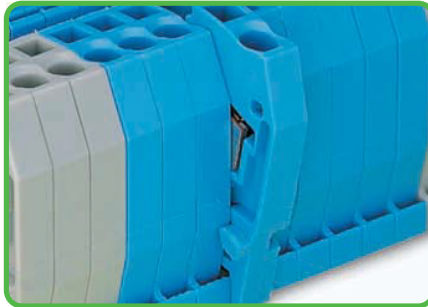

Quick assembly keys prevent reverse mounting.

Removal

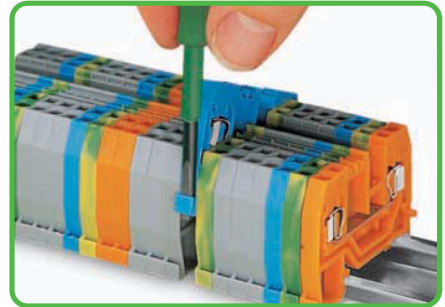

Removing a terminal block from the assembly.

Commoning



Commoning ground conductor terminal blocks with through terminal blocks is possible in one direction only (via rear side of terminal block) using adjacent jumpers. In addition to the required marking of these blocks, use yellow-green adjacent jumpers.

Commoning with step-down jumpers

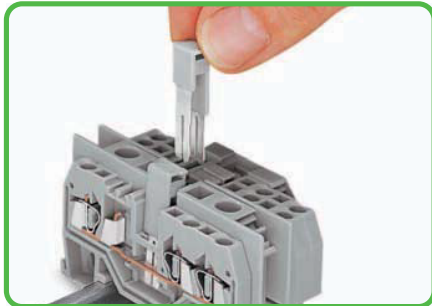

Commoning terminal blocks of different sizes – step down.
For application notes, see page 178.

Commoning

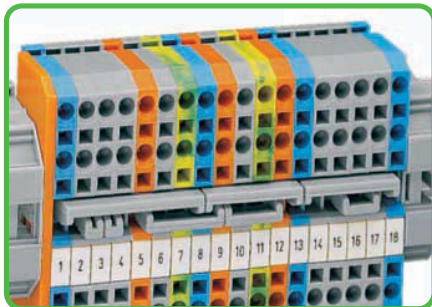

Staggered jumpers for sophisticated circuit requirements. Push jumpers down firmly until fully inserted. For additional notes, see page 201.

According to EN 60947-7-2 (VDE 0611, part 3), steel carrier rails shall not be used for PEN applications

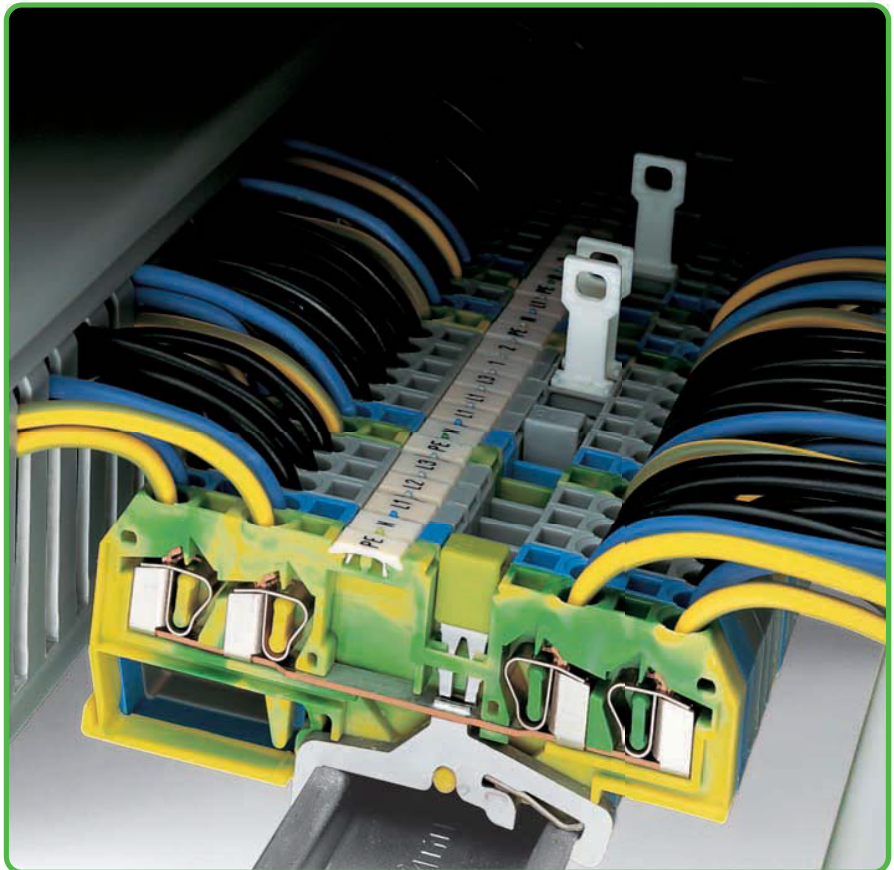

Testing - 880 Series

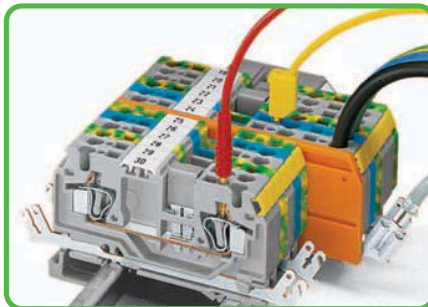

880 Series terminal blocks have an additional test slot for 2 mm Ø or 2.3 mm Ø test plugs.

Protective warning marker

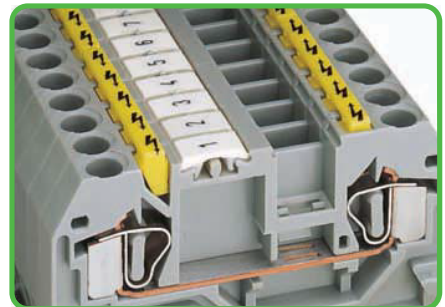

Protective warning markers inserted into the operating slots.



CAGE CLAMP®
clamps the following
copper conductors:*

solid

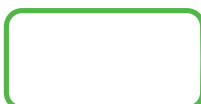

stranded



fine-stranded,
also with tinned
single strands

* For aluminum conductors, see notes in Section 14.

- Description and Handling -

CAGE CLAMP® connection

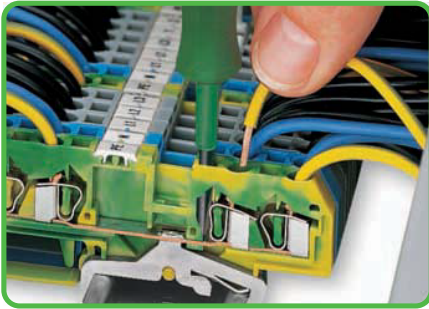

Conductor termination

CAGE CLAMP® connection

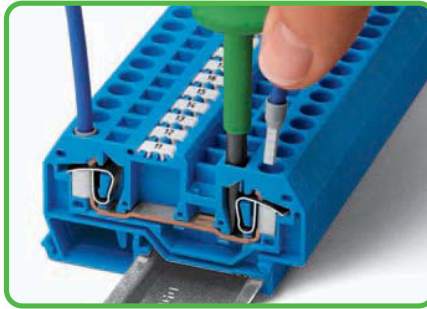

Conductor termination

❶ When using ferruled conductors, it is necessary to use a terminal block one size larger than the nominal cross section of the wire.

Testing

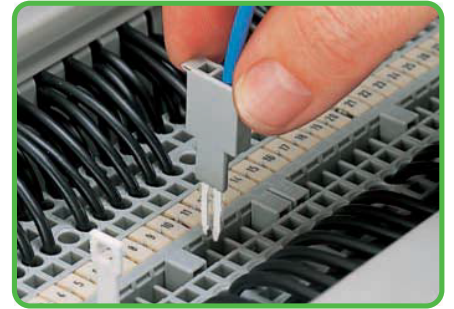

Testing with test plug.
Test plug fitted with CAGE CLAMP®.

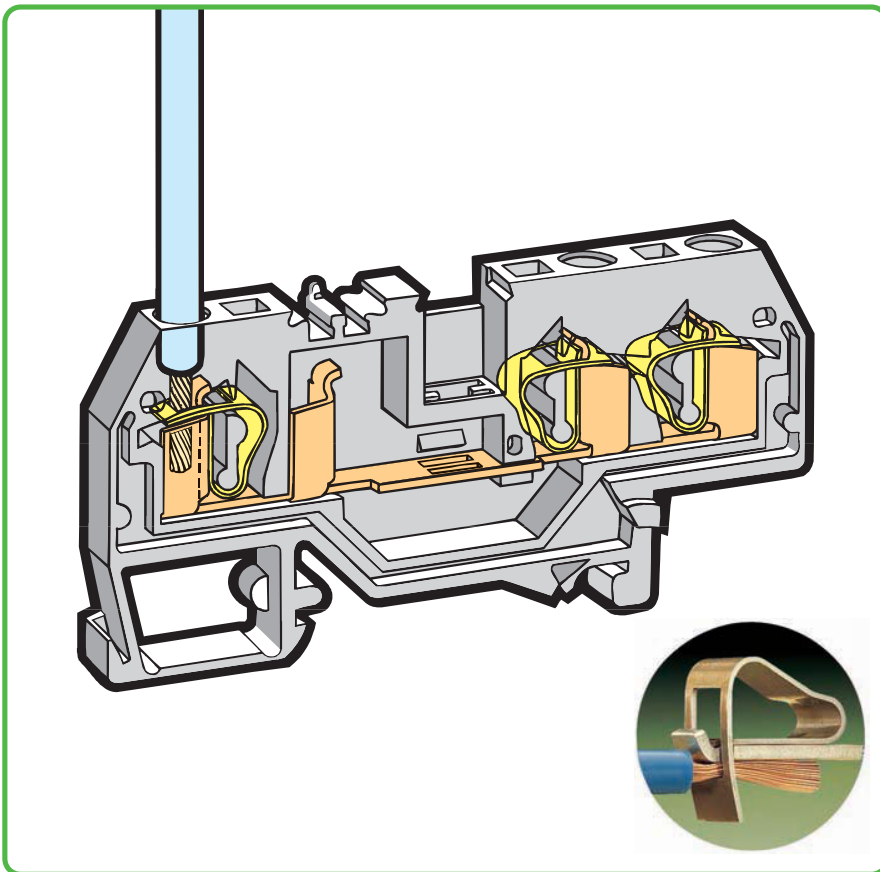

Testing

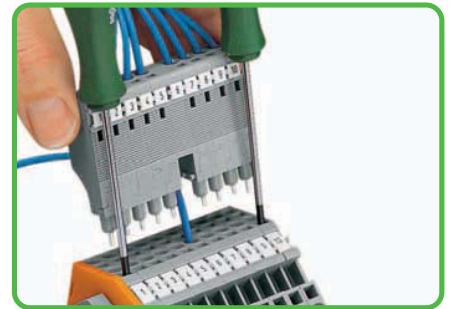

L-type test plug modules fitted with CAGE CLAMP®.
For application notes, see page 194.

Testing

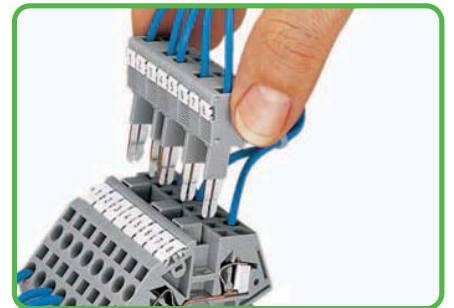

B-type test plug modules fitted with CAGE CLAMP®.
For application notes, see page 195.

Marking

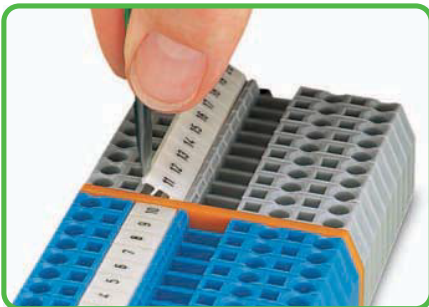

Marking with WMB Multi marking system.
For additional systems, see Section 13.

Insulation stop

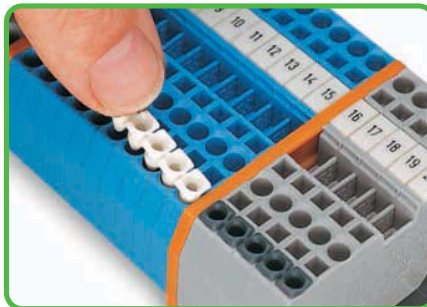

Insertion of insulation stop.
For application notes, see page 199.

Testing

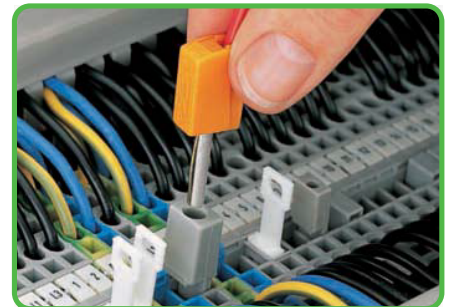

Testing with test plug.
Using 209-170 test plug adapter.



fine-stranded,
tip-bonded



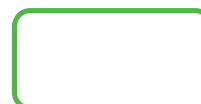

fine-stranded,
with ferrule ❶
(gastight crimped)



fine-stranded,
with pin terminal
(gastight crimped)

Through/Ground Conductor/Shield and Ex Terminal Blocks 2.5 mm² 280 Series



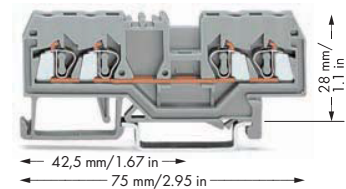
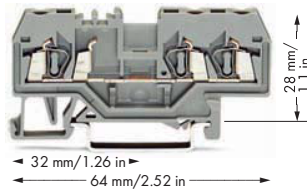
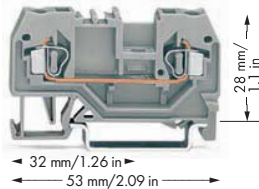

























0.08 - 2.5 mm² 800 V/8 kV/3 ① I _N 24 A Terminal block width 5 mm / 0.197 in  8 - 9 mm / 0.33 in ②	AWG 28 - 12 * 600 V, 20 A ⑤ 600 V, 25 A ⑥	0.08 - 2.5 mm² 800 V/8 kV/3 ① I _N 24 A Terminal block width 5 mm / 0.197 in  8 - 9 mm / 0.33 in ②	AWG 28 - 12 * 600 V, 20 A ⑤ 600 V, 15 A ⑥	0.08 - 2.5 mm² 800 V/8 kV/3 ① I _N 20 A Terminal block width 5 mm / 0.197 in  8 - 9 mm / 0.33 in ②	AWG 28 - 12 * 600 V, 20 A ⑤ 600 V, 25 A ⑥
---	--	---	--	---	--



Item No.	Pack. Unit	Item No.	Pack. Unit	Item No.	Pack. Unit
2-conductor through terminal block		3-conductor through terminal block		4-conductor through terminal block	
gray 280-901	100	gray 280-681	100	gray 280-833	100
blue 280-904 ③	100	blue 280-684 ③	100	blue 280-834 ③	100
orange 280-902	100	orange 280-650	100	orange 280-835	100
red 280-903	100	red 280-653	100	red 280-830	100
black 280-905	100	black 280-671	100	black 280-831	100
yellow 280-906	100	yellow 280-672	100	yellow 280-832	100
light gray ⑤ 280-992 ④	100	light gray ⑤ 280-993 ④	100	light gray ⑤ 280-994 ④	100
2-conductor ground terminal block		3-conductor ground terminal block		4-conductor ground terminal block	
green-yellow 280-907	100	green-yellow 280-687	100	green-yellow 280-837	100
green-yellow ⑤ 280-907/999-950 ④	100	green-yellow ⑤ 280-687/999-950 ④	100	green-yellow ⑤ 280-837/999-950 ④	100
Other terminal blocks with the same profile:		Other terminal blocks with the same profile:		Other terminal blocks with the same profile:	
Diode 280-915/281-410	Page 256	Diode 280-673/281-410	Page 256	Diode 280-815/281-410	Page 256
Disconnect 280-912	Page 206	Disconnect 280-683	Page 206	LED 280-809/281-434	Page 256
Carrier 280-916	Page 232	Carrier 280-610	Page 232	Disconnect 280-836	Page 206
				Disc., test & meas. 280-829	Page 206
				Carrier 280-816	Page 232
				Double-potential 280-826	Page 163
Item-Specific Accessories		Item-Specific Accessories		Item-Specific Accessories	
End and intermediate plate, 2.5 mm thick		End and intermediate plate, 2.5 mm thick		End and intermediate plate, 2.5 mm thick	
orange 280-309	100 (4x25)	orange 280-326	100 (4x25)	orange 280-315	100 (4x25)
gray 280-308	100 (4x25)	gray 280-324	100 (4x25)	gray 280-314	100 (4x25)
light gray 280-356	100 (4x25)	light gray 280-358	100 (4x25)	light gray 280-352	100 (4x25)
Separator, oversized, 2 mm thick		Separator, oversized, 2 mm thick		Separator, oversized, 2 mm thick	
orange 280-311	100 (4x25)	orange 280-346	100 (4x25)	orange 280-335	100 (4x25)
gray 280-310	100 (4x25)	gray 280-344	100 (4x25)	gray 280-334	100 (4x25)
light gray 280-357	100 (4x25)	light gray 280-359	100 (4x25)	light gray 280-353	100 (4x25)
Ex e/Ex i separator, orange, 3 mm thick		Ex e/Ex i separator, orange, 3 mm thick		Ex e/Ex i separator, orange, 3 mm thick	
90 mm 209-190	50 (2x25)	120 mm 209-191	50 (2x25)	120 mm 209-191	50 (2x25)
120 mm 209-191	50 (2x25)				
Spacer of same shape, 5 mm thick		Spacer of same shape, 5 mm thick		Spacer of same shape, 5 mm thick	
orange 280-902/056-000	100 (4x25)	orange 280-650/056-000	100	orange 280-835/056-000	100 (4x25)
				Cover plate, 1 mm thick	
				gray 284-336	100
				orange 284-346	100

For list of approvals and user guide, see pages 634 to 637.

- * AWG 12: THHN, THWN
- ① 800 V = rated voltage
8 kV = rated surge voltage
3 = pollution degree
(also see Section 14)
- ② Strip length, see packaging or instructions.
- ③ Suitable for Ex i applications
- ④ Suitable for Ex e II applications
0.2 mm² - 2.5 mm²/AWG 24 - 12*
550 V
23 A for 2-conductor terminal blocks
22 A for 3-conductor terminal blocks
20 A for 4-conductor terminal blocks
(also see Section 14)
Using staggered jumpers reduces the maximum rated voltage to 275 V.
- ⑤ See application notes for:
Test plug modules, pages 194 - 196
Banana plug, page 198
Insulation stop, page 199
Comb-style jumper bar, page 200
Operating tool, page 200
Staggered jumper, page 201
Push-in type wire jumper, page 201
Step-down jumper, pages 178 - 179

280 Series Accessories			Appropriate marking systems: WMB/WMB Inline/WFB (see Section 13)		
Insulation stop,  ⑤ 5 pcs/strip, 0.08 - 0.2 mm ² "s" (0.14 mm ² "f-st") white 280-470 200 (8x25)	Alternate comb-style jumper bar,  insulated, I _N = I _N terminal block 2-way 280-492 200 (8x25)	Banana plug,  ⑤ for socket 4 mm Ø, color mixed 215-111 50			
Insulation stop,  ⑤ 5 pcs/strip, 0.25 - 0.5 mm ² light gray 280-471 200 (8x25)	Operating tool, of insulating material  2-way 280-432 1 3-way 280-433 1	Test plug adapter, 6 mm wide,  with CAGE CLAMP®, for 0.08 - 2.5 mm ² I _N 24 A 281-407 100 (4x25)			
Insulation stop,  ⑤ 5 pcs/strip, 0.75 - 1 mm ² dark gray 280-472 200 (8x25)	Operating tool, of insulating material  10-way 280-440 1	WMB Inline, plain,  stretchable 5 - 5.2 mm, 1,500 WMB markers, 5 mm, on roll white 2009-115 1			
Adjacent jumper, insulated,  I _N = I _N terminal block gray 280-402 200 (8x25) yellow-green 280-422 200 (8x25)	Step-down jumper, insulated,  ⑤ I _N 15 A gray 284-414 50 (2x25)	WMB Multi marking system,  10 strips with 10 markers per card, stretchable 5 - 5.2 mm plain 793-5501 5			
Alternate jumper, insulated,  I _N = I _N terminal block gray 280-409 100 (4x25)	Cover plate,  1 mm thick gray 284-334 100 orange 284-344 100	WMB Multi marking system, plain,  10 strips with 10 markers per card, stretchable 5 - 5.2 mm yellow 793-5501/000-002 red 793-5501/000-005 blue 793-5501/000-006 gray 793-5501/000-007 orange 793-5501/000-012 light green 793-5501/000-017 green 793-5501/000-023 violet 793-5501/000-024 5			
Staggered jumper,  ⑤ insulated, width 5 mm/0.197 in, I _N 24 A from 1 to 2 780-452 100 (4x25) from 1 to 3 780-453 100 (4x25) from 1 to 4 780-454 100 (4x25) from 1 to 5 780-455 50 (2x25) from 1 to 6 780-456 50 (2x25) from 1 to 7 780-457 50 (2x25) from 1 to 8 780-458 50 (2x25)	Protective warning marker,  with high-voltage symbol, black, for 5 terminal blocks yellow 280-415 100 (4x25)				
	Test plug module,  ⑤ can be snapped together, 5 mm wide gray 280-418 100 (4x25)				
	Spacer module,  can be snapped together, 5 mm wide gray 280-419 100 (4x25)	Screwless end stop,  for DIN 35 rail, 6 mm wide gray 249-116 100 (4x25)			
Push-in type wire jumper,  ⑤ insulated, I _N 9 A, wire size 0.75 mm ² L = 60 mm 249-125 10 L = 110 mm 249-126 10 L = 250 mm 249-127 10	Test plug,  with 500 mm cable, 2 mm Ø red 210-136 50	Screwless end stop,  for DIN 35 rail, 10 mm wide gray 249-117 50 (2x25)			
	Test plug,  with 500 mm cable, 2.3 mm Ø yellow 210-137 50				
Comb-style jumper bar, insulated,  ⑤ I _N = I _N terminal block 2-way 280-482 200 (8x25) 3-way 280-483 200 (8x25)	Test plug adapter, 5 mm wide,  for terminal blocks 1.5 - 4 mm ² , for 210-137 test plug 2.3 mm Ø gray 280-404 100 (4x25)				
Comb-style jumper bar, insulated,  I _N = I _N terminal block 10-way 280-490 50 (2x25)	Test plug adapter, 8.3 mm wide,  for terminal blocks 1.5 - 10 mm ² , for test plug 4 mm Ø gray 209-170 50 (2x25)				