

Modular Terminal Blocks with Fixing Flange or Snap-In Mounting Foot 4 mm²

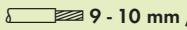

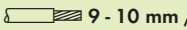









262 Series

CAGE CLAMP®

0.08 - 4 mm ² 630 V/8 kV/3 ① I _N 24 A	AWG 28 - 12 300 V, 20 A ② 300 V, 20 A ③	0.08 - 4 mm ² 630 V/8 kV/3 ① I _N 32 A	AWG 28 - 12 300 V, 20 A ② 300 V, 20 A ③
Terminal block width 7 mm / 0.276 in  9 - 10 mm / 0.37 in ④		Terminal block width 12 mm / 0.472 in  9 - 10 mm / 0.37 in ④	

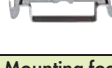

- ① 630 V = rated voltage
8 kV = rated surge voltage
3 = pollution degree
(also see Section 14)
- ② Strip length, see packaging or instructions.
- ③ Suitable for Ex i applications
- ④ See application notes for:
Test plug module, page 456

Color	Item No.	Pack. Unit	Color	Item No.	Pack. Unit	262 Series Accessories
2-conductor terminal block with fixing flange, for screw or similar mounting types, fixing hole 3.2 mm Ø, with 209-123 mounting adapter also for DIN 35 rail			4-conductor terminal block with fixing flange, for screw or similar mounting types, fixing hole 3.2 mm Ø, with 209-123 mounting adapter also for DIN 35 rail			
gray 262-301 100 (2x50) blue 262-304 ③ 100 (2x50) orange 262-306 100 (2x50) green-yellow 262-307 100 (2x50)			gray 262-331 100 (2x50) blue 262-334 ③ 100 (2x50) orange 262-336 100 (2x50) green-yellow 262-337 100 (2x50)			
2-conductor terminal block with snap-in mounting foot, for plate thickness 0.6-1.2 mm, fixing hole 3.5 mm Ø, fits 210-154 aluminum rail or with 209-120 mounting adapter for DIN 35 rail			4-conductor terminal block with snap-in mounting foot, for plate thickness 0.6-1.2 mm, fixing hole 3.5 mm Ø, fits 210-154 aluminum rail or with 209-120 mounting adapter for DIN 35 rail			Test plug,  with 500 mm cable, 2 mm Ø red 210-136 50
gray 262-311 100 (2x50) blue 262-314 ③ 100 (2x50) orange 262-316 100 (2x50) green-yellow 262-317 100 (2x50)			gray 262-341 100 (2x50) blue 262-344 ③ 100 (2x50) orange 262-346 100 (2x50) green-yellow 262-347 100 (2x50)			Test plug,  with 500 mm cable, 2.3 mm Ø yellow 210-137 50
2-conductor end terminal block, without fixing foot, for terminal strips with snap-in mounting feet			4-conductor end terminal block, without fixing foot, for terminal strips with snap-in mounting feet			Operating tool with partially insulated shaft,  type 2, (3.5 x 0.5) mm blade 210-720 1
gray 262-321 100 (2x50) blue 262-324 ③ 100 (2x50) orange 262-326 100 (2x50) green-yellow 262-327 100 (2x50)			gray 262-351 100 (2x50) blue 262-354 ③ 100 (2x50) orange 262-356 100 (2x50) green-yellow 262-357 100 (2x50)			
Item-Specific Accessories			Item-Specific Accessories			
Test plug module, ④  can be snapped together, 7 mm wide gray 249-137 100 (4x25)			Test plug module, ④  can be snapped together, 12 mm wide gray 249-140 100 (4x25)			
262 Series Accessories						
For marking accessories, see Section 13						
End plate with fixing flange  gray 262-361 50			Aluminum carrier rail,  1000 mm long, 18 mm wide, 7 mm high 210-154 1			
End plate with snap-in mounting foot  gray 262-371 50			End stop, for WSB Quick markers,  for 210-154 aluminum rail, 6 mm wide 209-122 2.5			
Comb-style jumper bar, insulated, I_N 16 A, gray,  reduces maximum conductor size to 2.5 mm ² /AWG 14 2-way 262-402 2.5			Mounting foot, for DIN 35 rail, can be snapped on  terminal blocks with snap-in mounting foot, 6.4 mm wide gray 209-120 2.5			
Operating tool, of insulating material,  for inserting comb-style jumper bars 2-way 209-132 1			Mounting foot with screw, for DIN 35 rail, can be  screwed on terminal blocks with fixing flange, 6.4 mm wide gray 209-123 2.5			

Modular Terminal Blocks and Terminal Strips 260 to 262 Series

Assembly

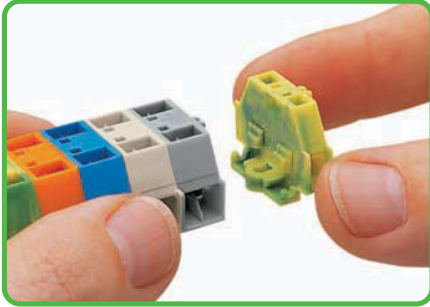

Assembling modular terminal blocks into terminal strips.

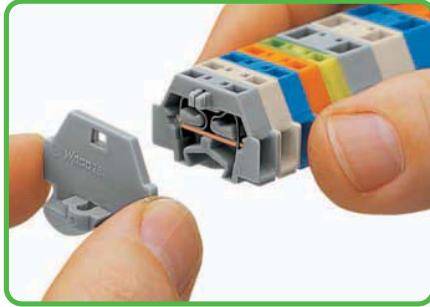

Mounting an end plate.

Fixing

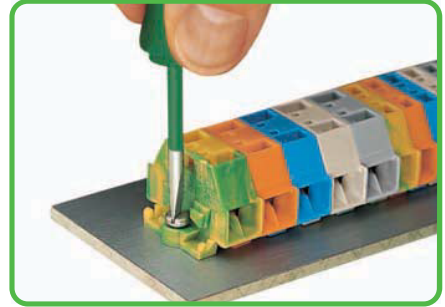

Terminal strip with fixing flanges, screw mount.

CAGE CLAMP® connection

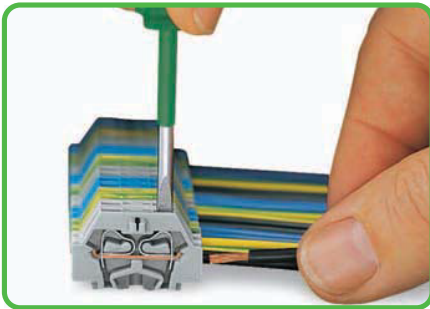

Conductor termination

CAGE CLAMP® connection

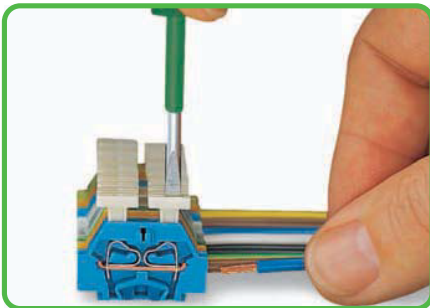

Conductor termination via push-button.

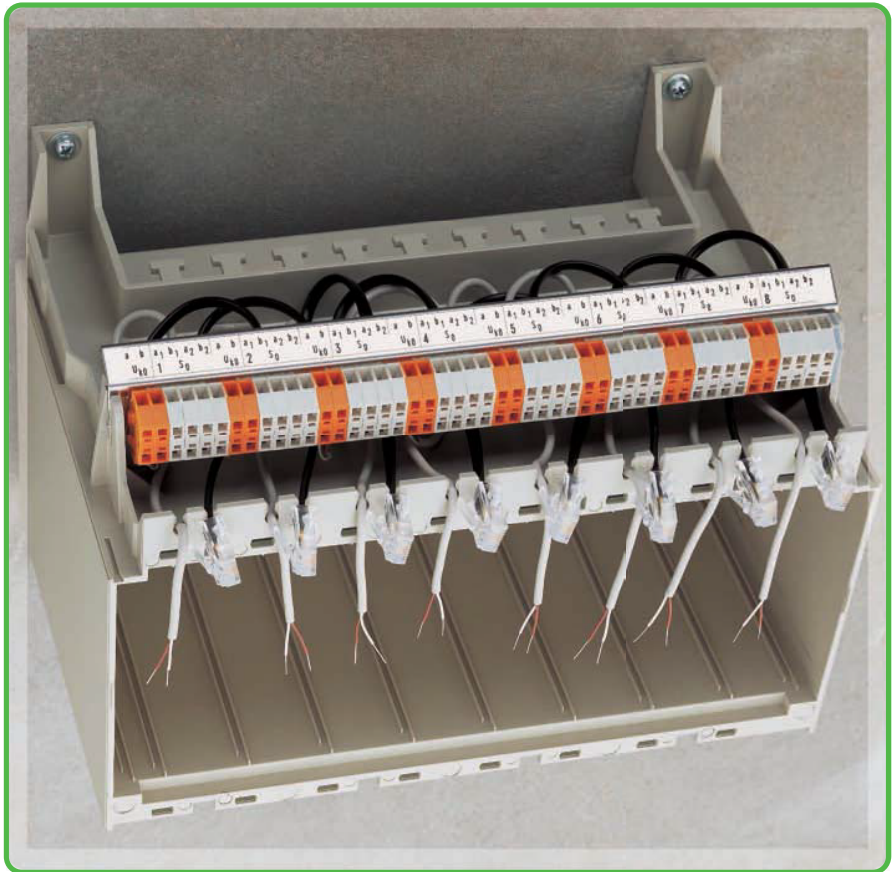

Types

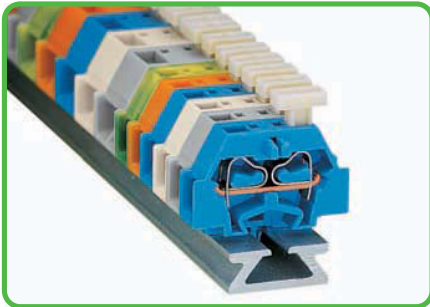

Terminal strip with push-buttons on one side.

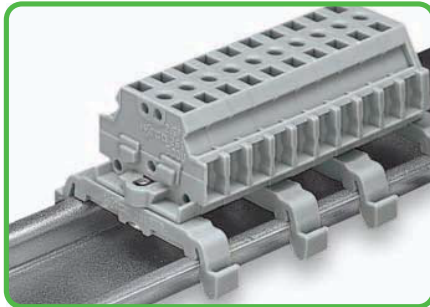

Terminal strip with marker slot for miniature WSB Quick marking system.

Commoning

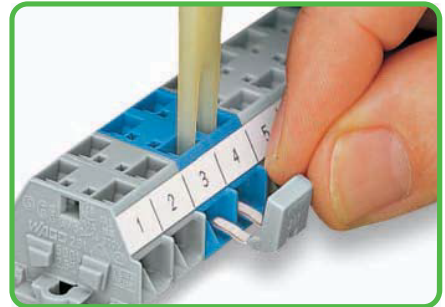

Commoning with comb-style jumper bar.

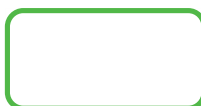

CAGE CLAMP®
clamps the following
copper conductors:*

solid

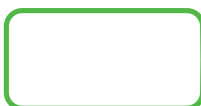

stranded

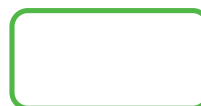

fine-stranded,
also with tinned
single strands

* For aluminum conductors, see notes in Section 14.

- Description and Handling -

Fixing



Terminal strip with snap-in mounting feet, mounting in holes.

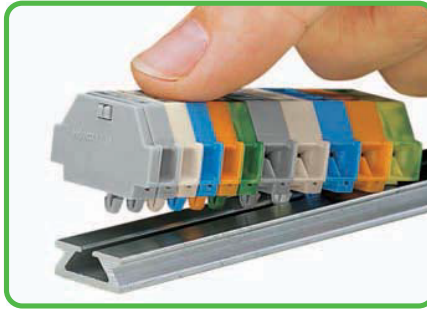

Terminal strip with snap-in mounting feet, mounting onto special aluminum rail.

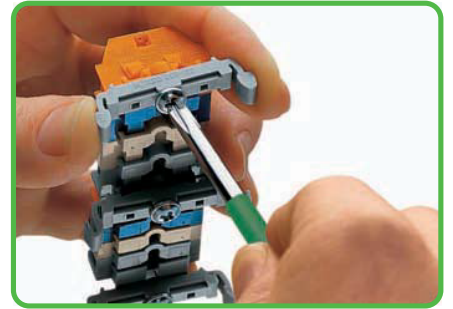

Terminal strip with fixing flanges, screw mounting of 209-123 mounting adapter (The distance between mounting adapters should be 35 - 40 mm / 1.378 - 1.575 in max.).

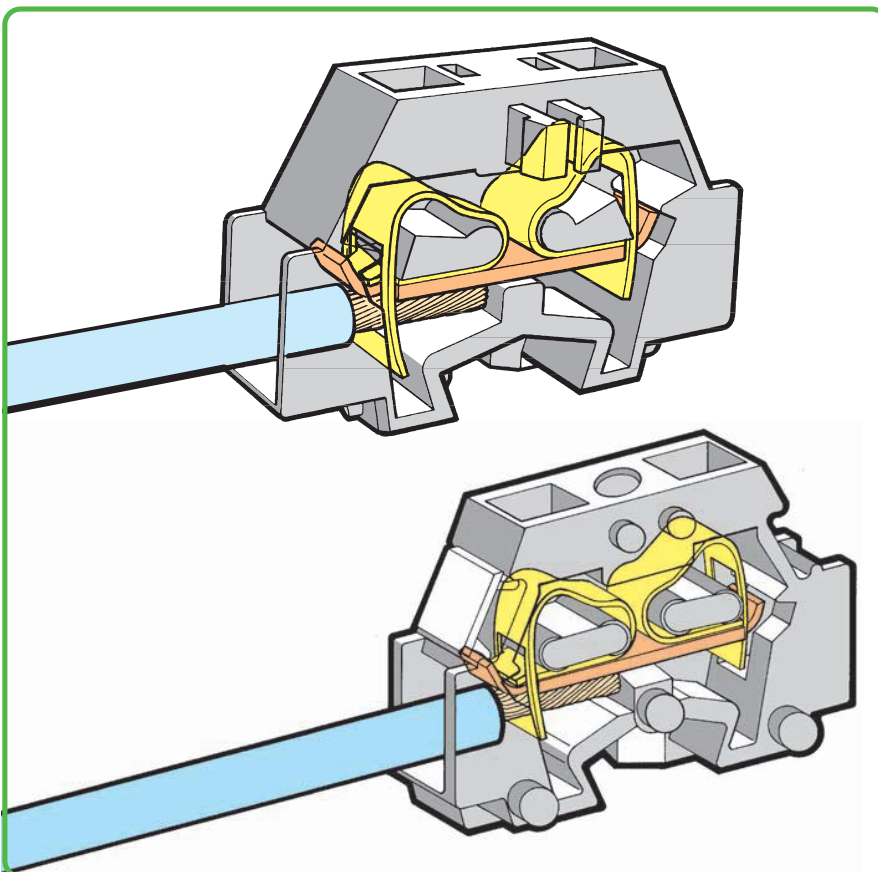

Fixing

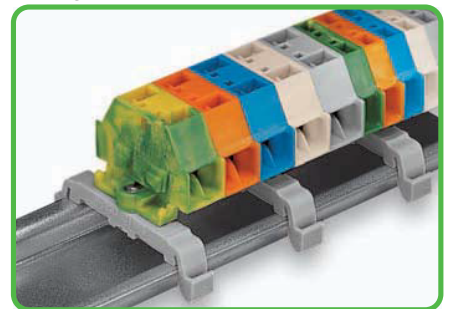

Terminal strip with fixing flanges, on DIN 35 rail.

Fixing

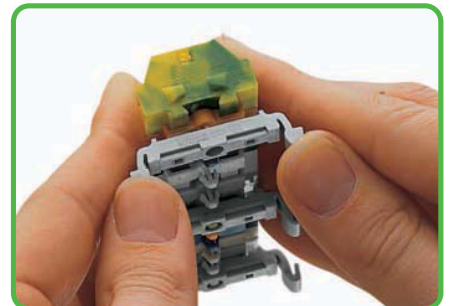

Terminal strip with snap-in mounting feet, connecting to 209-123 mounting adapter (The distance between mounting adapters should be 35 - 40 mm / 1.378 - 1.575 in max.).

Marking



Marking with self-adhesive marker strips.

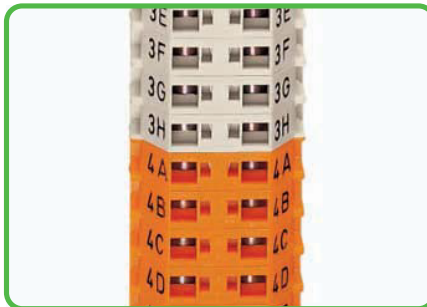

Marking by direct printing (on request).

Fixing

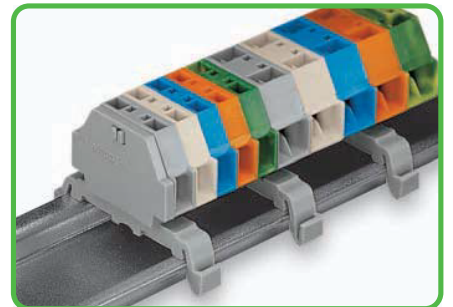

Terminal strip with snap-in mounting feet, on DIN 35 rail.

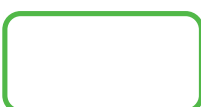

fine-stranded, tip-bonded

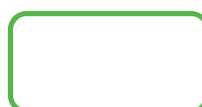

fine-stranded, with ferrule ① (gaslight crimped)

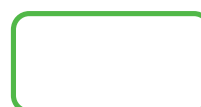

fine-stranded, with pin terminal (gaslight crimped)

① When using ferruled conductors, it is necessary to use a terminal block one size larger than the nominal cross section of the wire.