

# Modular Terminal Blocks and Terminal Strips 260 to 262 Series

## Assembly

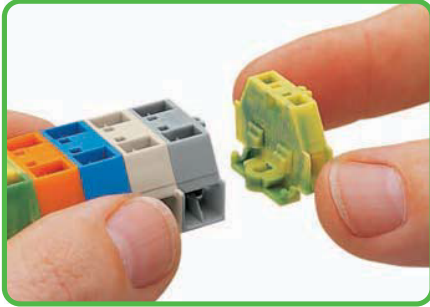

Assembling modular terminal blocks into terminal strips.

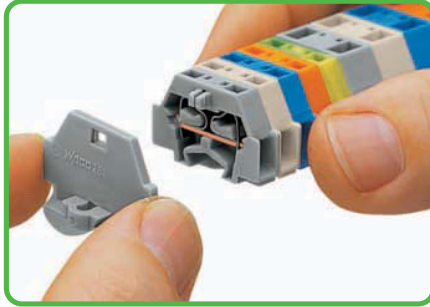

Mounting an end plate.

## Fixing

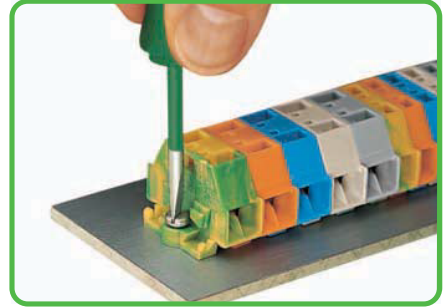

Terminal strip with fixing flanges, screw mount.

## CAGE CLAMP® connection

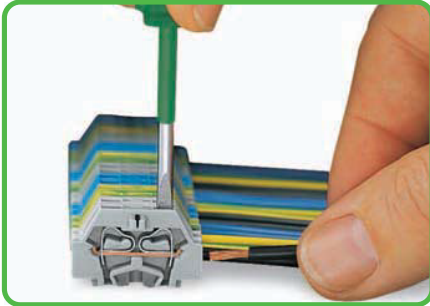

Conductor termination

## CAGE CLAMP® connection

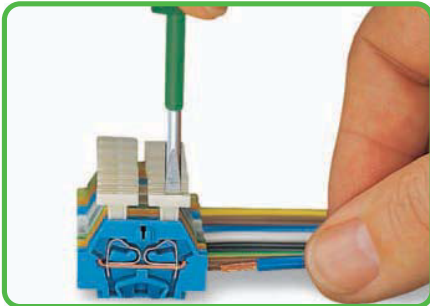

Conductor termination via push-button.

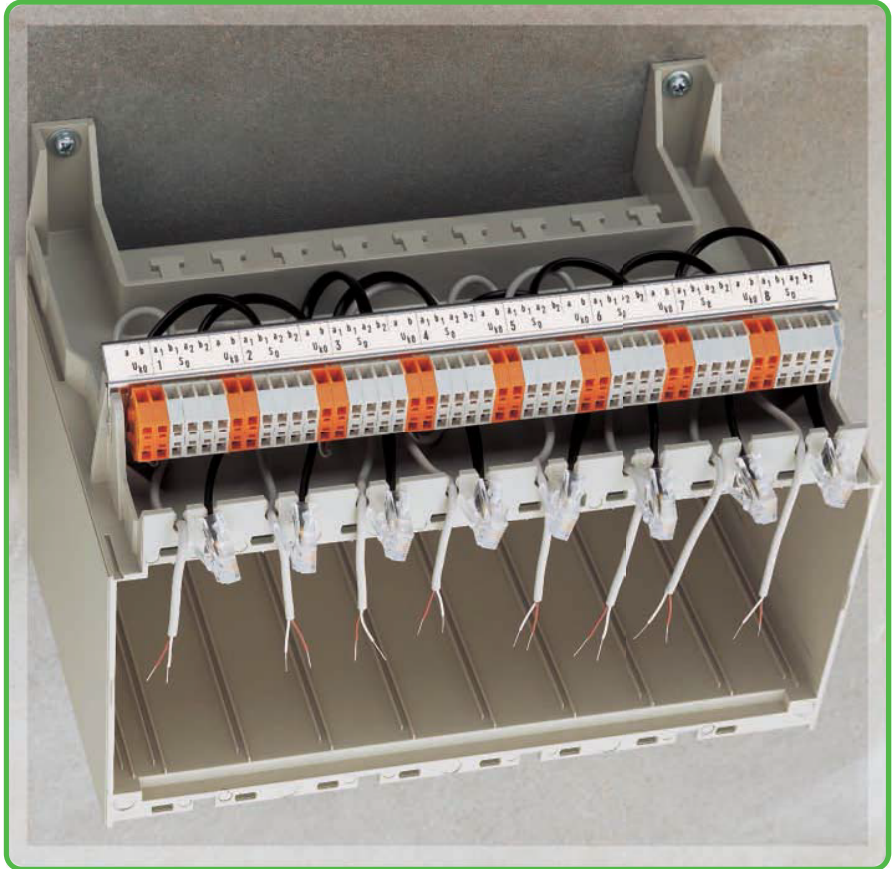

## Types

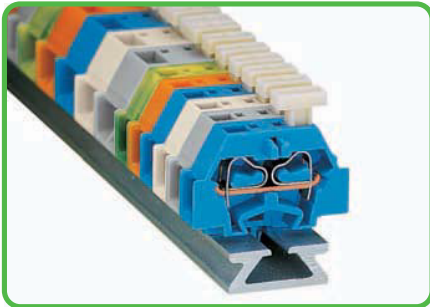

Terminal strip with push-buttons on one side.

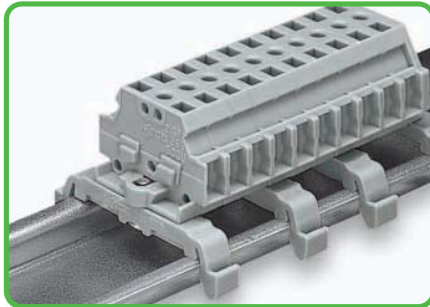

Terminal strip with marker slot for miniature WSB Quick marking system.

## Commoning

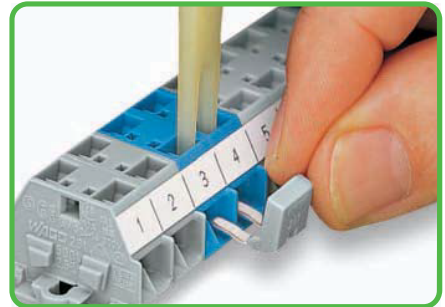

Commoning with comb-style jumper bar.

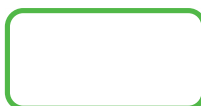

**CAGE CLAMP®**  
clamps the following  
copper conductors:\*

solid

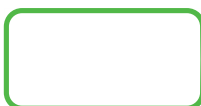

stranded

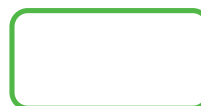

fine-stranded,  
also with tinned  
single strands

\* For aluminum conductors, see notes in Section 14.

## - Description and Handling -

### Fixing



Terminal strip with snap-in mounting feet, mounting in holes.

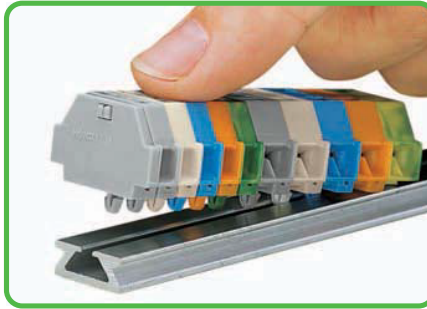

Terminal strip with snap-in mounting feet, mounting onto special aluminum rail.

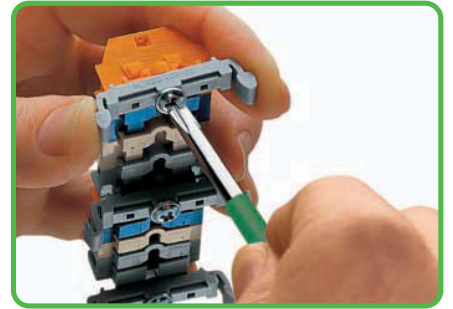

Terminal strip with fixing flanges, screw mounting of 209-123 mounting adapter (The distance between mounting adapters should be 35 - 40 mm / 1.378 - 1.575 in max.).

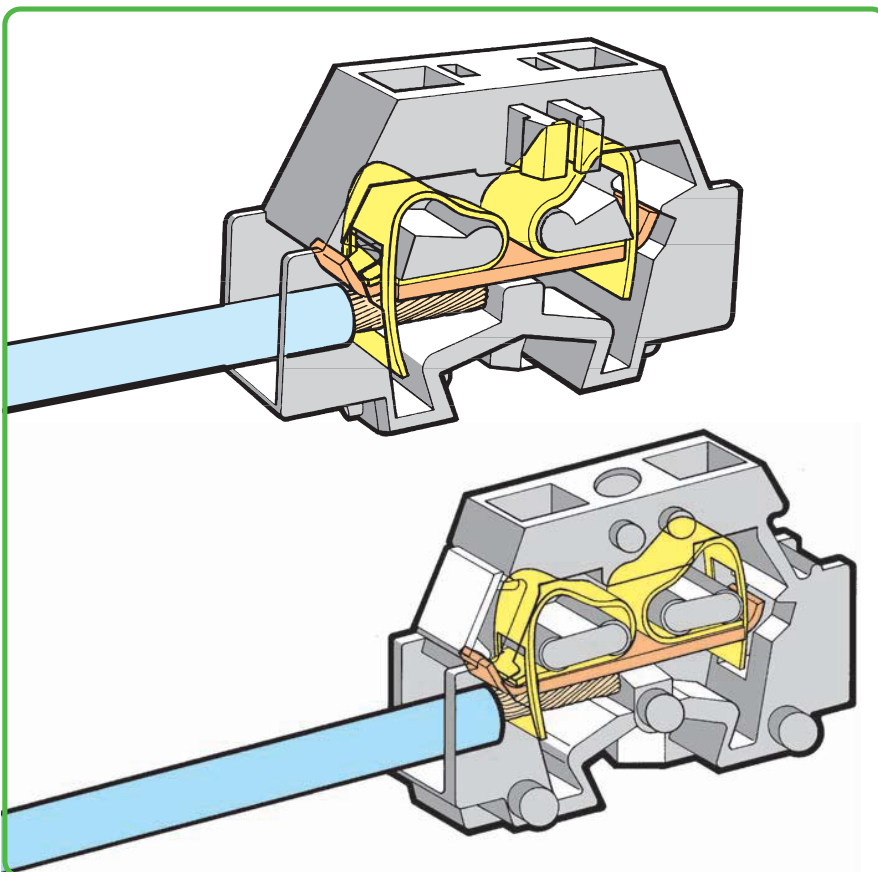

### Fixing

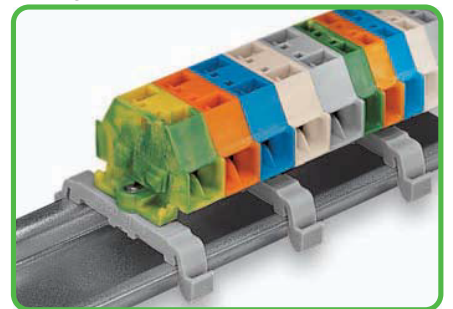

Terminal strip with fixing flanges, on DIN 35 rail.

### Fixing

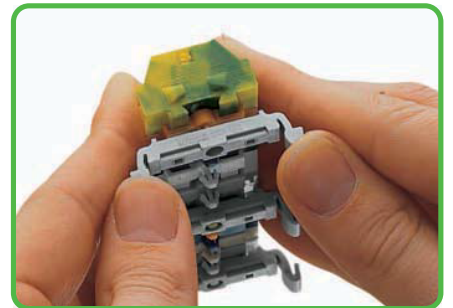

Terminal strip with snap-in mounting feet, connecting to 209-123 mounting adapter (The distance between mounting adapters should be 35 - 40 mm / 1.378 - 1.575 in max.).

### Marking



Marking with self-adhesive marker strips.

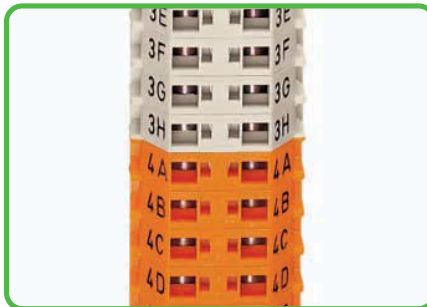

Marking by direct printing (on request).

### Fixing

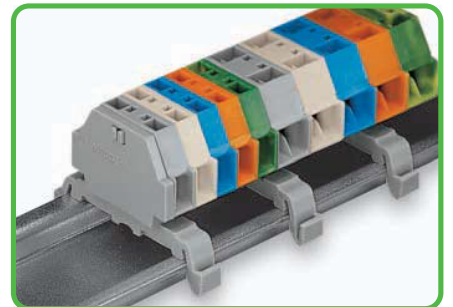

Terminal strip with snap-in mounting feet, on DIN 35 rail.

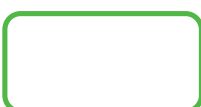

fine-stranded, tip-bonded

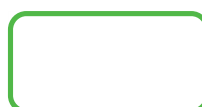

fine-stranded, with ferrule <sup>1</sup> (gaslight crimped)

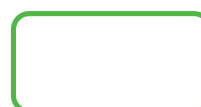

fine-stranded, with pin terminal (gaslight crimped)

<sup>1</sup> When using ferruled conductors, it is necessary to use a terminal block one size larger than the nominal cross section of the wire.

# Modular Terminal Blocks with Fixing Flange or Snap-In Mounting Foot 1.5 mm<sup>2</sup>





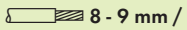
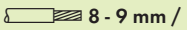





## 260 Series

CAGE CLAMP®

0.08 - 1.5 mm <sup>2</sup> 400 V/6 kV/3 ① I <sub>N</sub> 18 A	AWG 28 - 16 300 V, 10 A <sup>②</sup> 300 V, 15 A <sup>③</sup>	0.08 - 1.5 mm <sup>2</sup> 400 V/6 kV/3 ① I <sub>N</sub> 18 A	AWG 28 - 16 300 V, 10 A <sup>②</sup> 300 V, 15 A <sup>③</sup>
Terminal block width 5 mm / 0.197 in  8 - 9 mm / 0.33 in ②		Terminal block width 8 mm / 0.315 in  8 - 9 mm / 0.33 in ②	



- ① 400 V = rated voltage  
6 kV = rated surge voltage  
3 = pollution degree  
(also see Section 14)
- ② Strip length, see packaging or instructions.
- ③ See application notes for:  
Test plug module, page 456

Color	Item No.	Pack. Unit	Color	Item No.	Pack. Unit	260 Series Accessories
2-conductor terminal block with fixing flange, for screw or similar mounting types, fixing hole 3.2 mm Ø, with 209-123 mounting adapter also for DIN 35 rail			4-conductor terminal block with fixing flange, for screw or similar mounting types, fixing hole 3.2 mm Ø, with 209-123 mounting adapter also for DIN 35 rail			
gray	260-301	300 (6x50)	gray	260-331	300 (6x50)	
light gray	260-303	300 (6x50)	light gray	260-333	300 (6x50)	<b>Aluminum carrier rail,</b>  1000 mm long, 18 mm wide, 7 mm high <b>210-154</b> 1
blue	260-304	300 (6x50)	blue	260-334	300 (6x50)	<b>End stop,</b> for WSB Quick markers, for 210-154 aluminum rail, 6 mm wide  <b>209-122</b> 25
orange	260-306	300 (6x50)	orange	260-336	300 (6x50)	<b>Mounting foot,</b> for DIN 35 rail, can be snapped on terminal blocks with snap-in mounting foot, 6.4 mm wide  <b>209-120</b> 25
green-yellow	260-307	300 (6x50)	green-yellow	260-337	300 (6x50)	<b>Mounting foot with screw,</b> for DIN 35 rail, can be screwed on terminal blocks with fixing flange, 6.4 mm wide  <b>209-123</b> 25
2-conductor terminal block with snap-in mounting foot, for plate thickness 0.6-1.2 mm, fixing hole 3.5 mm Ø, fits 210-154 aluminum rail or with 209-120 mounting adapter for DIN 35 rail			4-conductor terminal block with snap-in mounting foot, for plate thickness 0.6-1.2 mm, fixing hole 3.5 mm Ø, fits 210-154 aluminum rail or with 209-120 mounting adapter for DIN 35 rail			<b>Mounting adapter,</b> for DIN 35 rail, can be used as end plate, 6.5 mm wide gray <b>209-137</b> 25
gray	260-311	300 (6x50)	gray	260-341	300 (6x50)	<b>Test plug,</b>  with 500 mm cable, 2 mm Ø, red <b>210-136</b> 50
light gray	260-313	300 (6x50)	light gray	260-343	300 (6x50)	<b>Test plug,</b>  with 500 mm cable, 2.3 mm Ø, yellow <b>210-137</b> 50
blue	260-314	300 (6x50)	blue	260-344	300 (6x50)	<b>Operating tool with partially insulated shaft,</b>  type 2, (3.5 x 0.5) mm blade <b>210-720</b> 1
orange	260-316	300 (6x50)	orange	260-346	300 (6x50)	
green-yellow	260-317	300 (6x50)	green-yellow	260-347	300 (6x50)	
2-conductor end terminal block, without fixing foot, for terminal strips with snap-in mounting feet			4-conductor end terminal block, without fixing foot, for terminal strips with snap-in mounting feet			
gray	260-321	300 (6x50)	gray	260-351	300 (6x50)	
light gray	260-323	300 (6x50)	light gray	260-353	300 (6x50)	
blue	260-324	300 (6x50)	blue	260-354	300 (6x50)	
orange	260-326	300 (6x50)	orange	260-356	300 (6x50)	
green-yellow	260-327	300 (6x50)	green-yellow	260-357	300 (6x50)	
<b>Item-Specific Accessories</b>			<b>Item-Specific Accessories</b>			
③  Test plug module, can be snapped together, 5 mm wide gray <b>249-135</b> 100 (4x25)			③  Test plug module, can be snapped together, 8 mm wide gray <b>249-138</b> 100 (4x25)			
③  Test plug module with locking levers, can be snapped together, 5 mm wide gray <b>260-404</b> 100 (4x25)			③  Test plug module with locking levers, can be snapped together, 8 mm wide gray <b>260-405</b> 100 (4x25)			
<b>260 Series Accessories</b>						
For marking accessories, see Section 13						
<b>End plate with fixing flange</b> gray <b>260-361</b> 300 (6x50)			<b>Comb-style jumper bar,</b> insulated, I <sub>N</sub> 10 A, gray, reduces maximum conductor size to 1 mm <sup>2</sup> /AWG 16 2-way <b>260-402</b> 25			
<b>End plate with snap-in mounting foot</b> gray <b>260-371</b> 300 (6x50)			<b>Operating tool,</b> of insulating material, for inserting comb-style jumper bars 2-way <b>209-132</b> 1			