

1 CAGE CLAMP® S Rail-Mounted Terminal Blocks 2000 to 2016 Series

50

Simply push-in



Directly insert solid and ferruled conductors.

Conductor termination



Terminating fine-stranded conductors using an operating tool.

Insulation stop

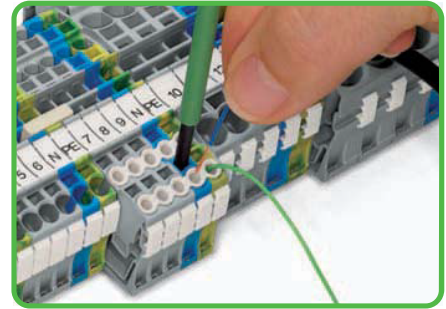

Conductor termination - Insulation stop.

Simply jumpered

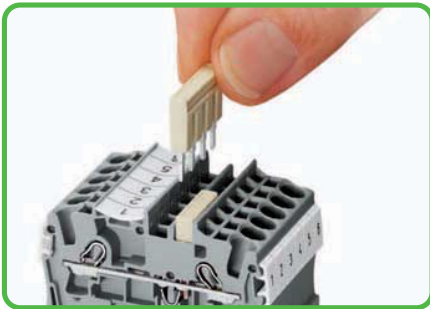

Insert push-in type jumper bar and push down firmly until it hits the backstop.

Customizable push-in type jumper bars

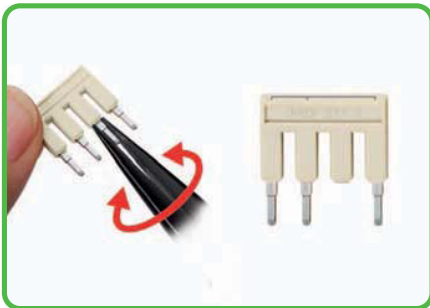

Breaking off jumper contacts (up to 4 mm²/AWG 12)

Customizable push-in type jumper bars



Marking with a felt-tip pen.

CAGE CLAMP®S for all conductor types

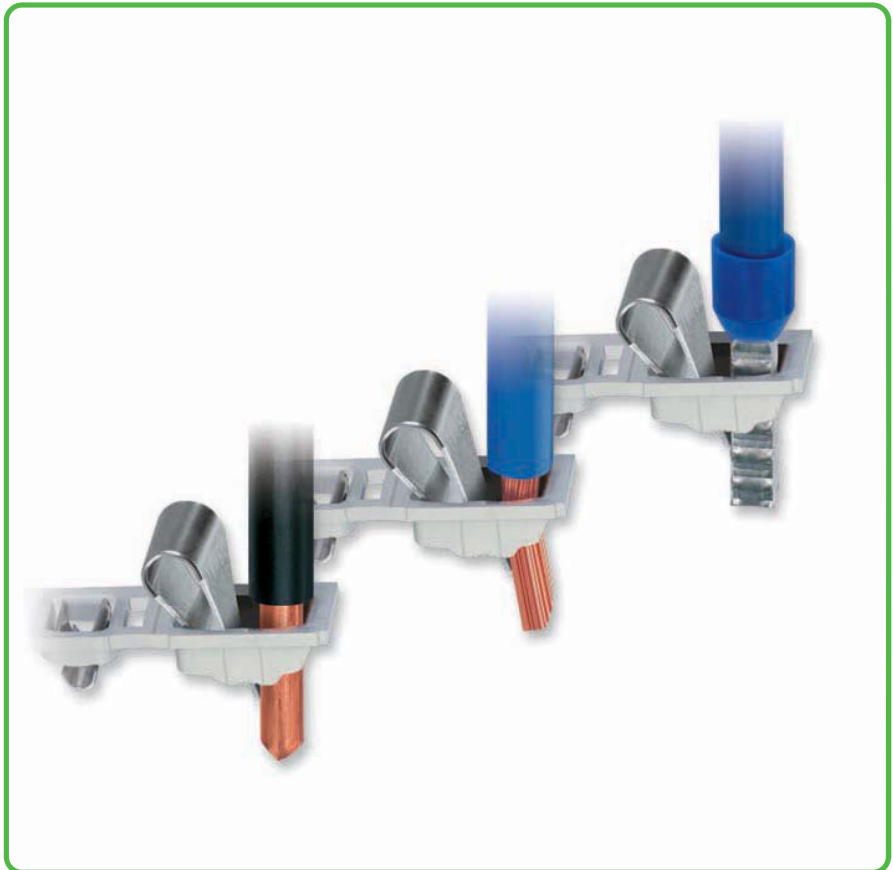

Commoning with step-down jumpers

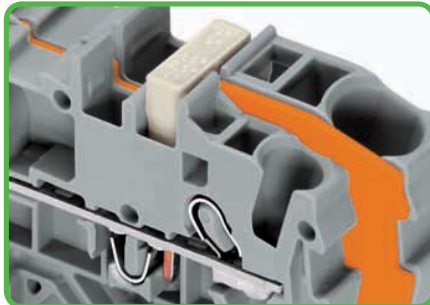

Commoning with step-down jumpers.

Star point jumpers

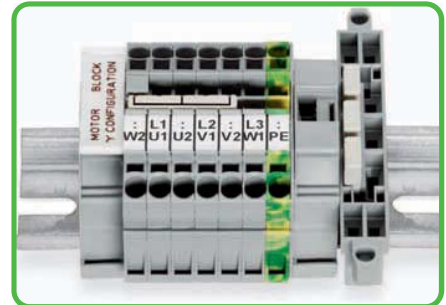

Star point jumpers designed for 'Y' configuration



CAGE CLAMP®S clamps the following copper conductors:*

solid

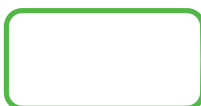

stranded

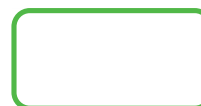

fine-stranded, also with tinned single strands

* For aluminum conductors, see notes in Section 14.

- Description and Handling -

Simply smaller



Up to 30% more compact. Advantage: More wiring space or smaller switch cabinets/junction boxes.

TOPJOB®S connectors



The 2001, 2002 and 2004 Series terminal blocks are equipped with a test socket for 2 mm Ø or 2.3 mm Ø test plugs.

Testing tap



Testing tap suited for 2001 to 2016 Series terminal blocks. Tool-free connections for individual test wires up to 2.5 mm²/AWG 12.



Test plug adapter



The test plug adapter for 4 mm Ø plugs is suited for 2001 to 2016 Series terminal blocks.

Simply marked



Marker strips for center marking

Wire jumpers



Push down the wire jumper until fully inserted. Lift the jumper with an operating tool for rewiring.

Marking



WMB InLine
WMB markers on roll

Marking



TOPJOB®S group marker carrier, snap-on type for jumper slot



fine-stranded,
tip-bonded



fine-stranded,
with ferrule,
(gaslight crimped)



fine-stranded,
with pin terminal
(gaslight crimped)

Double-Potential Terminal Blocks 2.5 (4) mm² 2002 Series Accessories for Rail-Mounted Terminal Blocks

CAGE CLAMP® S



- ① Conductor sizes: 0.25 mm² – 4 mm² “s + f-st”; Push-in conductor sizes: 0.75 mm² – 4 mm² “s” and 0.75 mm² – 2.5 mm² “insulated ferrule, 12 mm”
- ② 800 V = rated voltage
8 kV = rated surge voltage
3 = pollution degree
(also see Section 14)
- ③ Strip length, see packaging or instructions.
- ④ Suitable for Ex i applications
- ⑤ Suitable for Ex e II applications
550 V, 22 A
Jumper 20 A
(also see Section 14)
- ⑥ See application notes for:
Ex e/Ex i separator plate, page 52
Colored push-in type jumper bars, page 139
Staggered jumper, page 141
Delta jumper, page 140
Star point jumper, page 140
Step-down jumper, page 67
Adjacent jumper for continuous commoning, page 139
Push-in type wire jumper, page 140
TOPJOB®S connector, page 134
TOPJOB®S L-type test plug module, page 136
Marker carrier, page 145

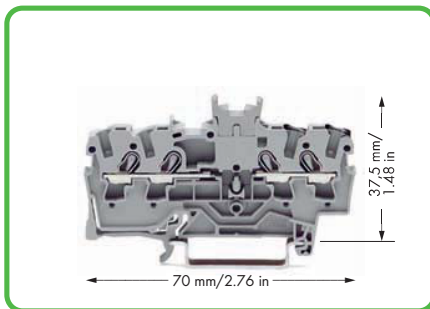

Double-potential terminal block with double marker slot centered on terminal block
gray 2002-1441
Packing unit: 100 pcs















Notice: This double-potential terminal block cannot be commoned with push-in type jumper bars!

Double-potential terminal blocks are space savers. Two independent feedthrough circuits are placed in one insulated housing on one level in just 5.2 mm/0.205 in. This achieves a width of just 2.6 mm/0.103 in versus standard through terminal blocks. Input and output contacts of one circuit are placed on the same side of the terminal block. Both circuits can be individually marked according to input and output.

For technical data and accessories, see www.wagocatalog.com

2002 Series Accessories

Appropriate marking systems: WMB/Marking strips/WMB Inline
(see Section 13)

Staggered jumper,  insulated, I_N 25 A, light gray 2-way 2002-472 100 (4x25) 3-way 2002-473 100 (4x25) 4-way 2002-474 100 (4x25) 5-way 2002-475 50 (2x25) 6-way 2002-476 50 (2x25) 7-way 2002-477 50 (2x25) 8-way 2002-478 50 (2x25) 9-way 2002-479 50 (2x25) 10-way 2002-480 50 (2x25) 11-way 2002-481 50 (2x25) 12-way 2002-482 50 (2x25)	Push-in type wire jumper,  insulated, I_N 16 A, wire size 1.5 mm ² L = 60 mm 2009-412 100 (10x10) L = 110 mm 2009-414 100 (10x10) L = 250 mm 2009-416 100 (10x10)
Customized staggered jumper,  insulated, I_N 25 A, light gray 1-3 2002-473/011-000 100 (4x25) 1-3-5 2002-475/011-000 100 (4x25) 1-3-5-7 2002-477/011-000 100 (4x25) 1-3-5-7-9 2002-479/011-000 100 (4x25) 1-3-5-7-9-11 2002-481/011-000 50 (2x25)	Modular TOPJOB®S connector,  can be snapped together, for jumper contact slot gray 2002-511 100 (4x25)
Delta jumper, insulated,  $I_N = I_N$ terminal block, light gray 1-2 3-4 5-6 2002-406/020-000 100 (4x25)	Spacer module, can be snapped together, e.g., for bridging commoned terminal blocks gray 2002-549 100 (4x25)
Star point jumper, insulated,  $I_N = I_N$ terminal block, light gray 1-3-5 2002-405/011-000 100 (4x25)	End plate, for modular TOPJOB®S connectors, 1.5 mm thick gray 2002-541 100 (4x25)
Step-down jumper, insulated,  I_N 32 A light gray 2006-499 50 (2x25)	Test plug adapter,  for test plug 4 mm Ø gray 2009-174 100 (4x25)
Adjacent jumper for continuous commoning,  insulated, I_N 25 A, light gray 2-way 2002-400 100 (4x25)	Testing tap,  for max. 2.5 mm ² gray 2009-182 100 (4x25)
WMB Inline, plain,  stretchable 5 - 5.2 mm, 1,500 WMB markers, 5 mm, on roll white 2009-115 1	TOPJOB®S test plug module,  can be snapped together gray 2002-611 100 (4x25)
	TOPJOB®S spacer, can be snapped together, e.g., for bridging commoned terminal blocks gray 2002-649 100 (4x25)
	End plate, for modular TOPJOB®S test plugs, 1.5 mm thick gray 2002-641 100 (4x25)
	Marker carrier,  for jumper slots 2002 Series, 5 mm wide gray 2002-161 100 (4x25)
	WMB Multi marking system,  10 strips with 10 markers per card, stretchable 5 - 5.2 mm plain 793-5501 5