

Compact Rail-Mounted Terminal Blocks for DIN 15 and DIN 35 Rails 870 Series

Assembly

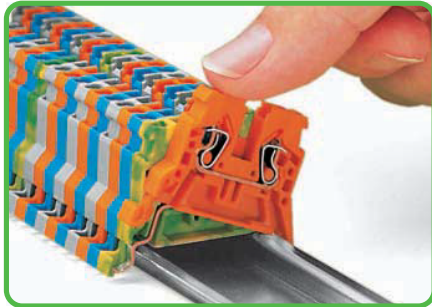

Snapping a rail-mount terminal block onto DIN 35 carrier rail.

Removal

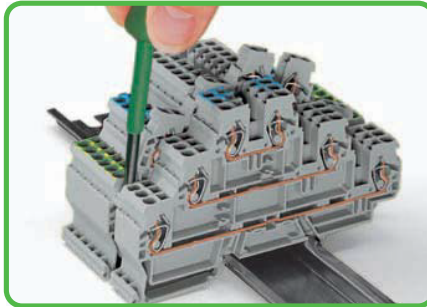

Removing a terminal block from the assembly.

Insulation stop

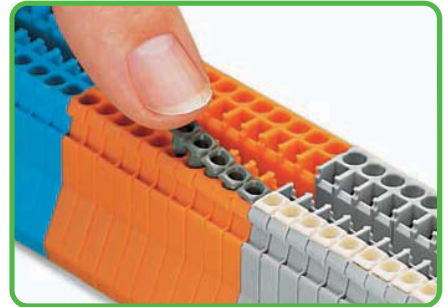

Inserting an insulation stop.

Push-in type jumper bar system



Push jumper bars down firmly until fully inserted. When using multipole bars, push alternately on right and then left side, until installed.
Push-in type jumper bars 1 - 3 - 5 - 7 or 1 - - 4 - - 7 upon request.

Push-in type jumper bar system

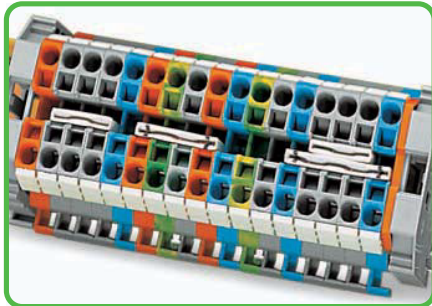

Two parallel jumper receptacles are accommodated in one terminal block.

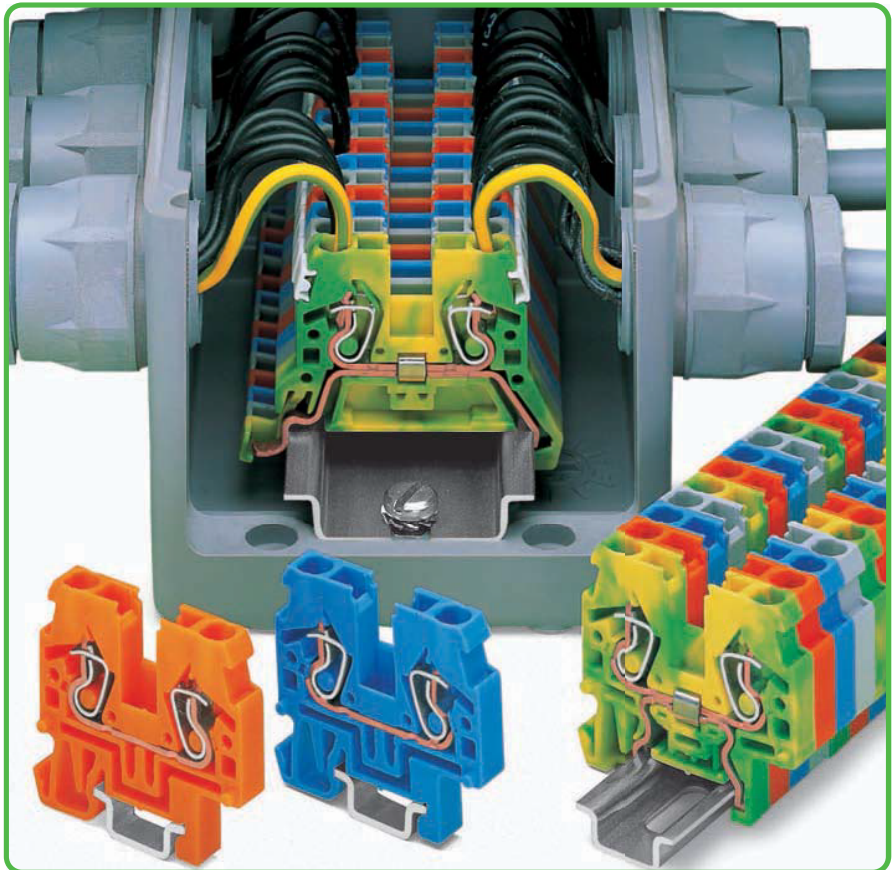

Commoning with step-down jumpers

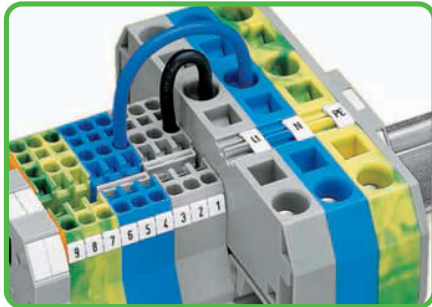

Commoning terminal blocks of different sizes - step down.

Testing

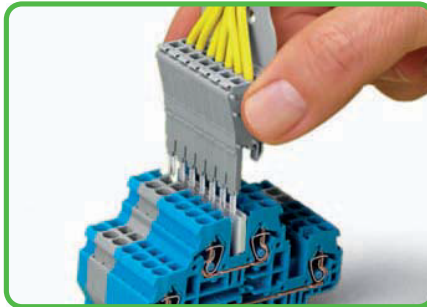

Testing is also possible using a pre-wired module assembly, similar to test plugs.

Testing

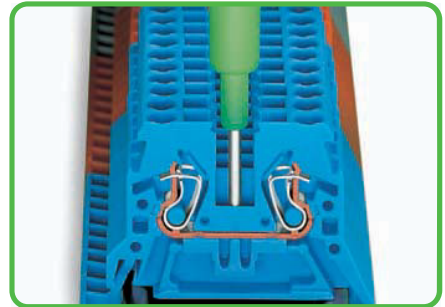

Testing with phase testing device, also possible with single-pole voltage tester.



CAGE CLAMP® clamps the following copper conductors:*

solid



stranded



fine-stranded, also with tinned single strands

* For aluminum conductors, see notes in Section 14.

① When using ferrules, the max. conductor cross section accommodated is one size smaller than max. rating of terminal block.

- Description and Handling -

CAGE CLAMP® connection

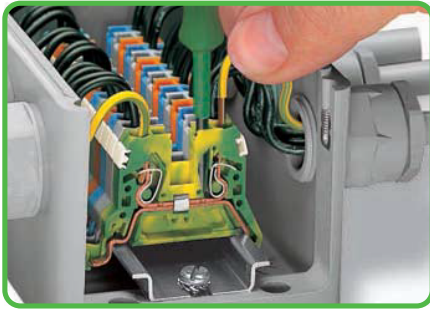

Terminating fine-stranded conductors ranging from 0.08 to 4 mm² (AWG 28 - 12).

CAGE CLAMP® connection

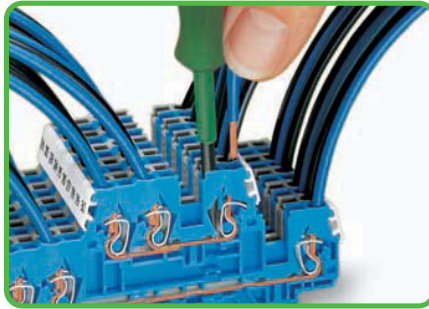

Multilevel terminal blocks

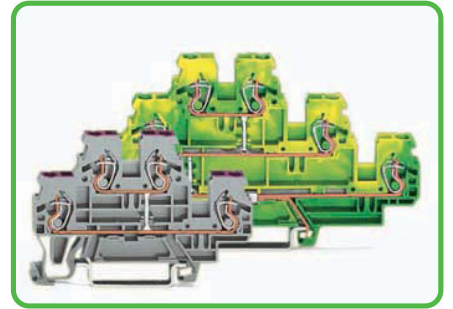

Double- and triple-deck terminal blocks with internal commoning acting as 4- and 6-conductor terminal blocks.

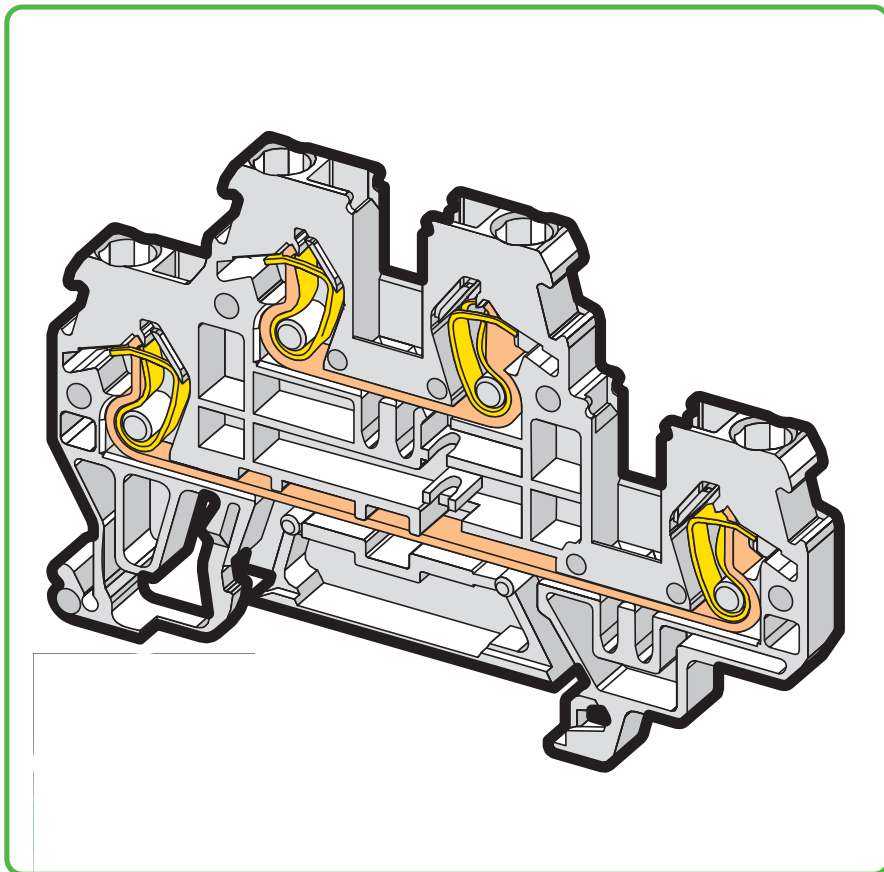

Protective warning marker

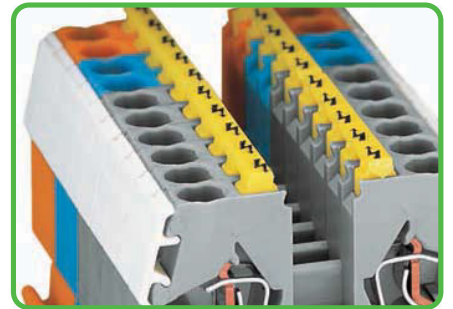

Protective warning markers (280-405), with black high-voltage symbols.

Marking

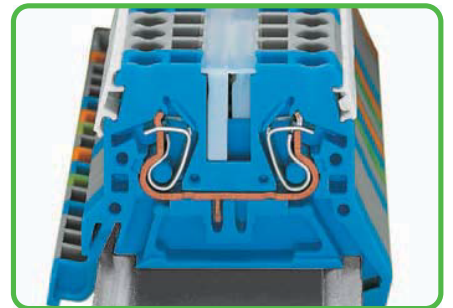

Marking the clamping unit via WMB Multi marking system or miniature WSB Quick marking system.

Space saver

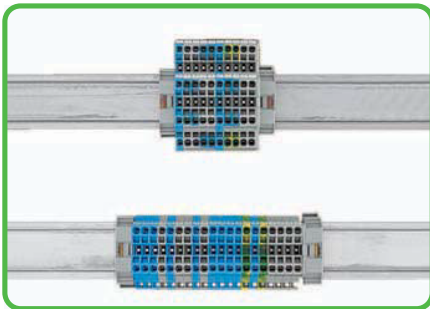

Save 50% of rail space when using double-deck terminal blocks.

Space saver

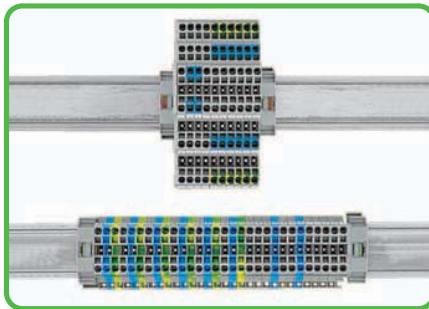

Save 67% of rail space when using triple-deck terminal blocks.

Marking Strips

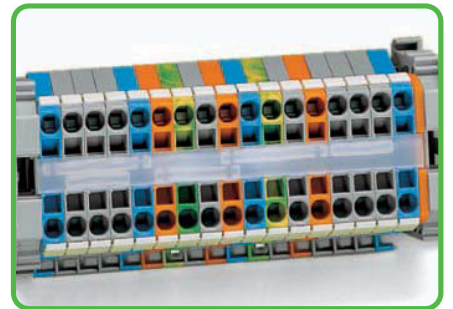

Transparent marker strips (note: Jumpers below may be visible).

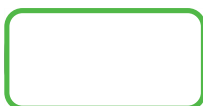

fine-stranded, tip-bonded

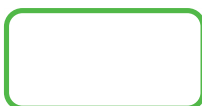

fine-stranded, with ferrule ① (gastight crimped)

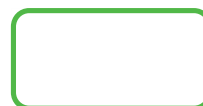

fine-stranded, with pin terminal (gastight crimped)

0.08 - 2.5 (4 "f-st") mm² ① AWG 28 - 12
 500 V/6 kV/3 ② 300 V, 20 A. 
 I_N 24 A

Terminal block width 5 mm / 0.197 in
 6 - 7 mm / 0.26 in ③

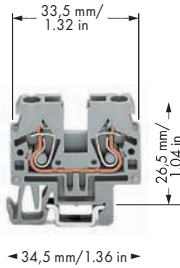

Assembly:
 Snap individual terminal blocks onto DIN 15 carrier rail and slide together.
Removal:
 Open assembly by laterally sliding terminal blocks with an operating tool and remove them from the rail.

- ① Max. insulation diameter: 4.4 mm
- ② 500 V = rated voltage
 6 kV = rated surge voltage
 3 = pollution degree
 (also see Section 14)
- ③ Strip length, see packaging or instructions.
- ④ Suitable for Ex i applications
- ⑤ Suitable for Ex e II applications
 0.2 mm² - 2.5 (4 "f-st") mm²/AWG 24 - 12
 440 V, 22 A
 Using push-in type jumper bars 1 to X, the maximum rated voltage is reduced to 275 V and the rated current to 13.5 A
 (also see Section 14)
- ⑥ See application notes for:
 Insulation stop, page 199
 Tap-off module, page 283

| Item No. | Pack. Unit |
|---|---------------|
| 2-conductor through terminal block, for DIN 15 rail | |
| gray | 870-911 100 |
| blue | 870-914 ④ 100 |
| orange | 870-912 100 |
| light gray  | 870-919 ⑤ 100 |
| 2-conductor ground terminal block, for DIN 15 rail, Notice: This ground conductor terminal block cannot be commoned with push-in type jumper bars. | |
| green-yellow | 870-917 100 |

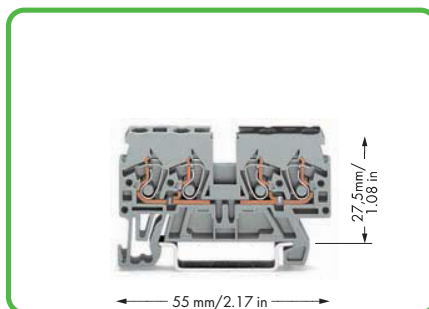



Double-potential terminal block
 with integrated marking position.
 gray 870-826
 Packing unit: 100 pcs



Protective warning markers inserted into the operating slots.

Notice: This double-potential terminal block cannot be commoned with push-in type jumper bars!

| Item-Specific Accessories | | | |
|---|------------|---------|------------|
| End and intermediate plate, 2 mm thick | | | |
|  | orange | 870-924 | 100 (4x25) |
| | gray | 870-923 | 100 (4x25) |
| | light gray | 870-925 | 100 (4x25) |
| Separator, oversized, 2 mm thick | | | |
|  | orange | 870-929 | 100 (4x25) |
| | gray | 870-928 | 100 (4x25) |



For technical data and accessories, see www.wago.com



Miniature WSB or WMB markers provide marking directly on terminal block.



In order to meet creepage and clearance requirements for Ex e applications, it is necessary to insert an end or intermediate plate between a through and a ground conductor terminal block.
 End plates 870-923 (gray), 870-924 (orange) and 870-925 (light gray), as well as separator plates 870-928 (gray) and 870-929 (orange) cannot be assembled to 870-907/999-950 2-conductor ground Ex terminal blocks.







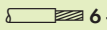
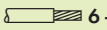
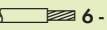

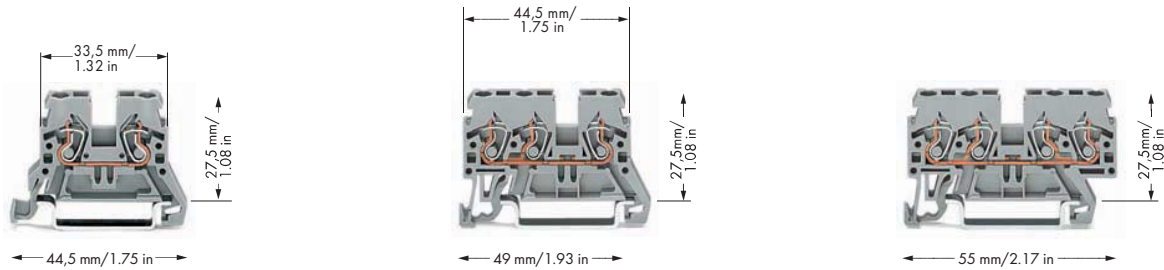







| | | | |
|--|--------|---------|------------|
| Protective warning marker, with high-voltage symbol, black, for 5 terminal blocks | | | |
|  | yellow | 280-405 | 100 (4x25) |
| Tap-off module with anti-reverse mating protection,  can be snapped together, 5 mm wide | | | |
| | gray | 870-425 | 100 (4x25) |
| Miniature WSB Quick marking system, 10 strips with 10 markers per card, 5 mm wide markers | | | |
|  | plain | 248-501 | 5 |

WAGO front-entry double-potential terminal blocks are space savers.
 Two independent feedthrough circuits are placed in one insulated housing on one level in just 5 mm/0.197 in. This achieves a width of just 2.5 mm/0.098 in is achieved versus standard through terminal blocks for a total height of only 27.5 mm/1.08 in from the upper edge of the carrier rail.
 Input and output contacts of one circuit are placed on the same side of the terminal block. Both circuits can be individually marked according to input and output.

Through/Ground Conductor and Ex Terminal Blocks 2.5 mm² (4 mm² "f-st") for DIN 35 and DIN 15 Rails 870 Series

| | | |
|---|---|---|
| 0.08 - 2.5 (4"f-st")mm² ① AWG 28 - 12 500 V/6 kV/3 ② I _N 24 A Terminal block width 5 mm / 0.197 in  6 - 7 mm / 0.26 in ③ | 0.08 - 2.5 (4"f-st")mm² ① AWG 28 - 12 500 V/6 kV/3 ② I _N 24 A Terminal block width 5 mm / 0.197 in  6 - 7 mm / 0.26 in ③ | 0.08 - 2.5 (4"f-st")mm² ① AWG 28 - 12 500 V/6 kV/3 ② I _N 24 A Terminal block width 5 mm / 0.197 in  6 - 7 mm / 0.26 in ③ |
|---|---|---|



| Item No. | Pack. Unit | Item No. | Pack. Unit | Item No. | Pack. Unit |
|--|------------------------------|--|---------------------------|--|---------------------------|
| 2-conductor through terminal block, for DIN 35 rail | | 3-conductor through terminal block, for DIN 35 rail | | 4-conductor through terminal block, for DIN 35 rail | |
| ● gray | 870-901 100 | ● gray | 870-681 100 | ● gray | 870-831 100 |
| ● blue | 870-904 ④ 100 | ● blue | 870-684 ④ 100 | ● blue | 870-834 ④ 100 |
| ● orange | 870-902 100 | ● orange | 870-682 100 | ● orange | 870-832 100 |
| ● light gray ⑤ | 870-909 ⑤ 100 | | | | |
| 2-conductor ground terminal block, for DIN 35 rail, Notice: This ground conductor terminal block cannot be commoned with push-in type jumper bars. | | 3-conductor ground terminal block, for DIN 35 rail, Notice: This ground conductor terminal block cannot be commoned with push-in type jumper bars. | | 4-conductor ground terminal block, for DIN 35 rail, Notice: This ground conductor terminal block cannot be commoned with push-in type jumper bars. | |
| ● green-yellow | 870-907 100 | ● green-yellow | 870-687 100 | ● green-yellow | 870-837 100 |
| ● green-yellow ⑤ | 870-907/999-950 ⑤ 100 | | | | |
| Item-Specific Accessories | | Item-Specific Accessories | | Item-Specific Accessories | |
| End and intermediate plate, 2 mm thick | | End and intermediate plate, 1 mm thick | | End and intermediate plate, 1 mm thick | |
|  orange | 870-924 100 (4x25) |  orange | 870-934 100 (4x25) |  orange | 870-944 100 (4x25) |
|  gray | 870-923 100 (4x25) |  gray | 870-933 100 (4x25) |  gray | 870-943 100 (4x25) |
|  light gray | 870-925 100 (4x25) | | | | |
| Separator, oversized, 2 mm thick | | Separator, oversized, 1 mm thick | | Separator, oversized, 1 mm thick | |
|  orange | 870-929 100 (4x25) |  orange | 870-947 100 (4x25) |  orange | 870-949 100 (4x25) |
|  gray | 870-928 100 (4x25) |  gray | 870-946 100 (4x25) |  gray | 870-948 100 (4x25) |
| End and intermediate plate, 2 mm thick, for 2-conductor ground conductor Ex terminal blocks only | | | | | |
|  green-yellow | 870-926 100 (4x25) | | | | |
| Ex e/Ex i separator, orange, 3 mm thick | | | | | |
|  90 mm | 209-190 50 (2x25) | | | | |
|  120 mm | 209-191 50 (2x25) | | | | |

Other terminal blocks with the same profile:
Double-potential **870-826** Page 277

870 Series Accessories

Appropriate marking systems: WMB/Miniature WSB (see Section 13)

| Insulation stop, ④ | Push-in type jumper bar, insulated, I _N 18 A, light gray | Push-in type jumper bar, insulated, I _N 18 A, light gray |
|---|---|---|
| 5 pcs/strip, 0.08 - 0.2 mm ² "s" (0.14 mm ² "f-st") white 280-470 200 (8x25) | 2-way 870-402 200 (8x25) | from 1 to 3 870-433 200 (8x25) |
| | 3-way 870-403 200 (8x25) | from 1 to 4 870-434 200 (8x25) |
| | 4-way 870-404 200 (8x25) | from 1 to 5 870-435 100 (4x25) |
| | 5-way 870-405 100 (4x25) | from 1 to 6 870-436 100 (4x25) |
| | 6-way 870-406 100 (4x25) | from 1 to 7 870-437 100 (4x25) |
| | 7-way 870-407 100 (4x25) | from 1 to 8 870-438 100 (4x25) |
| | 8-way 870-408 100 (4x25) | from 1 to 9 870-439 100 (4x25) |
| | 9-way 870-409 100 (4x25) | from 1 to 10 870-440 100 (4x25) |
| | 10-way 870-410 100 (4x25) | |

For list of approvals and user guide, see pages 634 to 637.