

Rail-Mounted Terminal Blocks 279 to 285 Series and 880 Series

Assembly

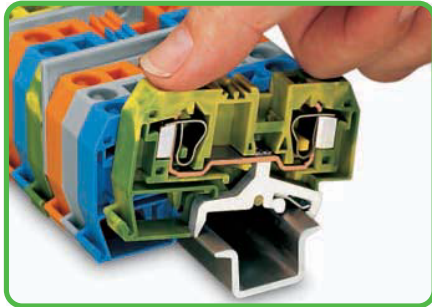

By snapping a ground conductor terminal block onto the carrier rail, a direct electrical connection is automatically made to the rail.

Assembly

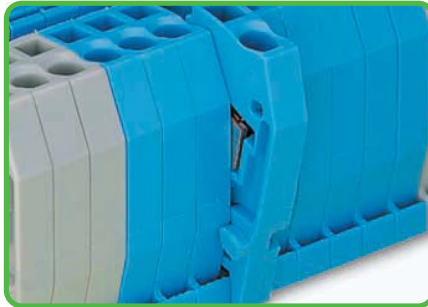

Quick assembly keys prevent reverse mounting.

Removal

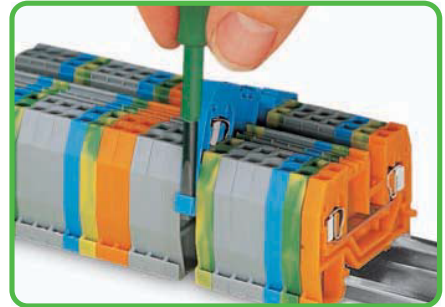

Removing a terminal block from the assembly.

Commoning



Commoning ground conductor terminal blocks with through terminal blocks is possible in one direction only (via rear side of terminal block) using adjacent jumpers. In addition to the required marking of these blocks, use yellow-green adjacent jumpers.

Commoning with step-down jumpers

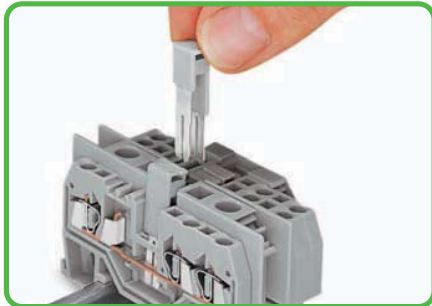

Commoning terminal blocks of different sizes – step down.
For application notes, see page 178.

Commoning

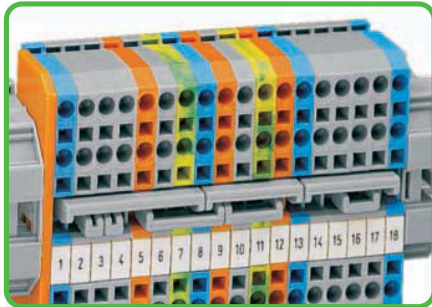

Staggered jumpers for sophisticated circuit requirements. Push jumpers down firmly until fully inserted. For additional notes, see page 201.

According to EN 60947-7-2 (VDE 0611, part 3), steel carrier rails shall not be used for PEN applications

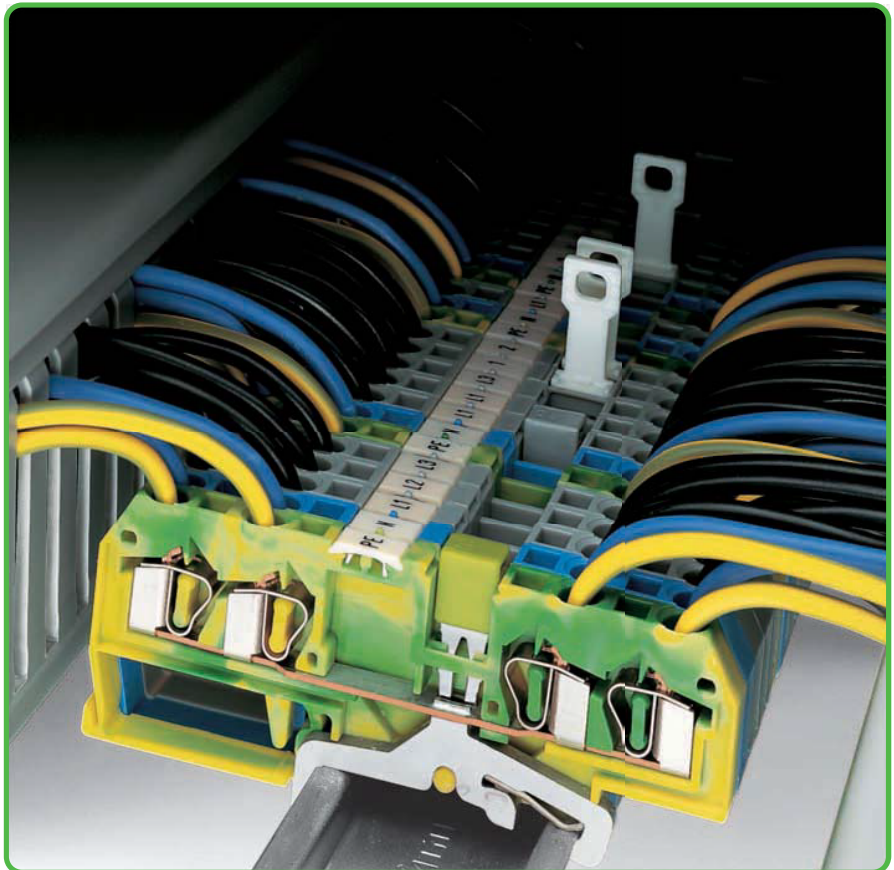

Testing - 880 Series

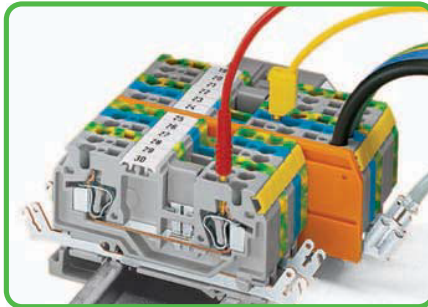

880 Series terminal blocks have an additional test slot for 2 mm Ø or 2.3 mm Ø test plugs.

Protective warning marker

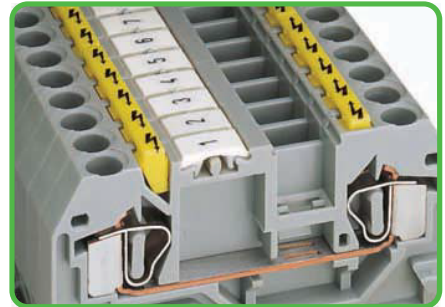

Protective warning markers inserted into the operating slots.

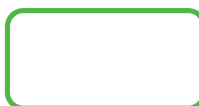

CAGE CLAMP®
clamps the following
copper conductors:*

solid

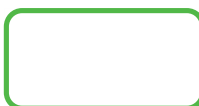

stranded

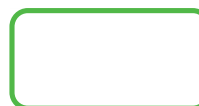

fine-stranded,
also with tinned
single strands

* For aluminum conductors, see notes in Section 14.

- Description and Handling -

CAGE CLAMP® connection

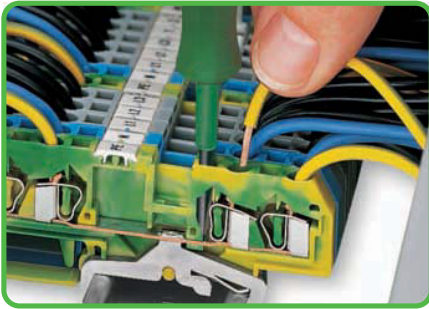

Conductor termination

CAGE CLAMP® connection

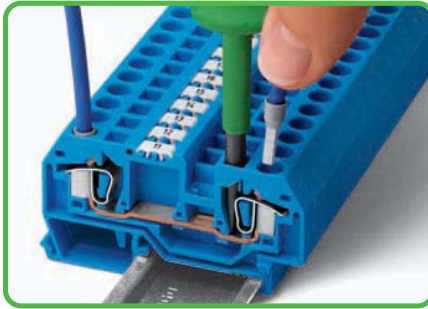

Conductor termination

❶ When using ferruled conductors, it is necessary to use a terminal block one size larger than the nominal cross section of the wire.

Testing

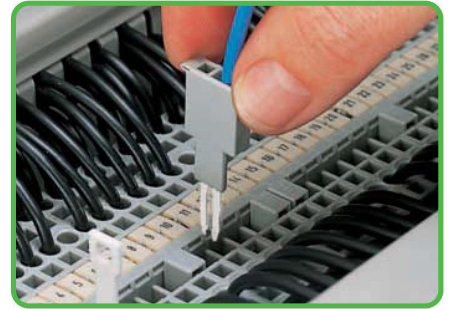

Testing with test plug.
Test plug fitted with CAGE CLAMP®.

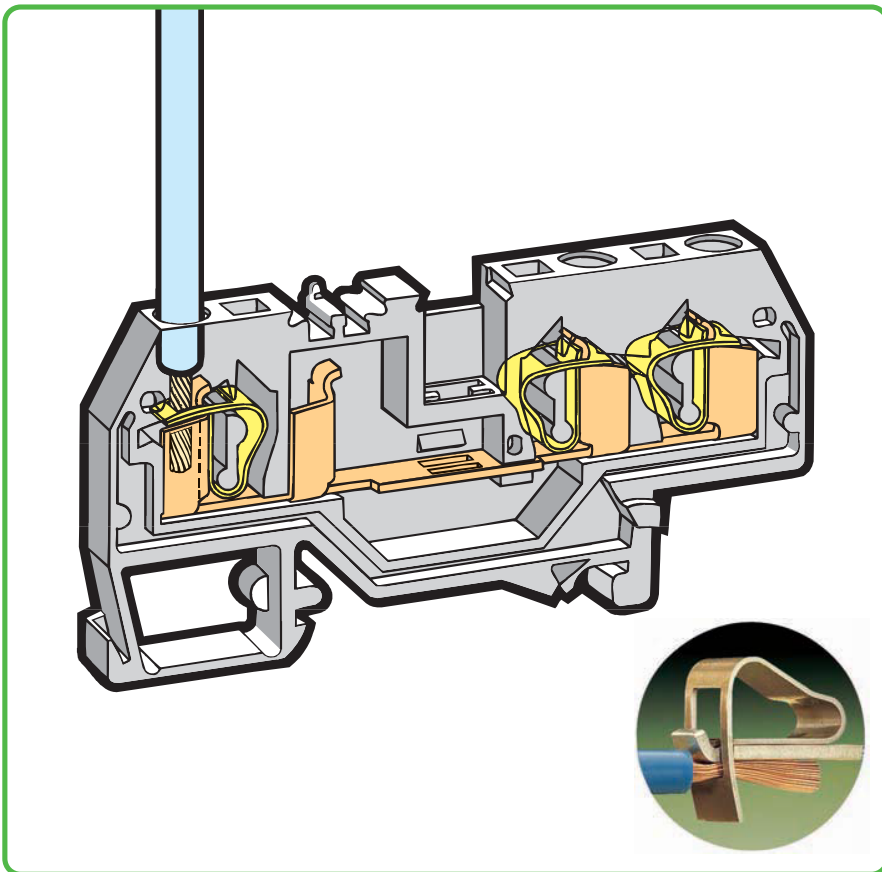

Testing

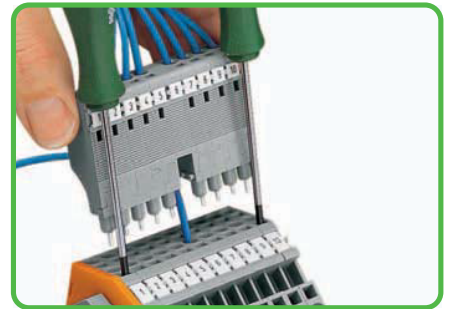

L-type test plug modules fitted with CAGE CLAMP®.
For application notes, see page 194.

Testing

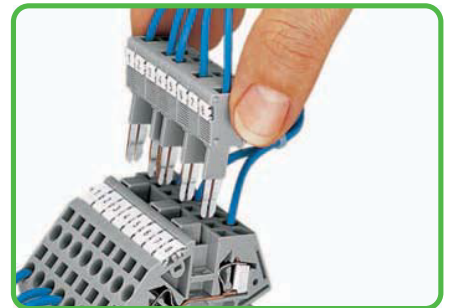

B-type test plug modules fitted with CAGE CLAMP®.
For application notes, see page 195.

Marking



Marking with WMB Multi marking system.
For additional systems, see Section 13.

Insulation stop

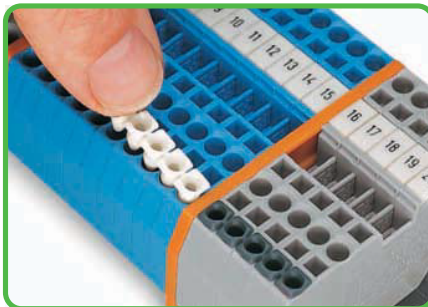

Insertion of insulation stop.
For application notes, see page 199.

Testing

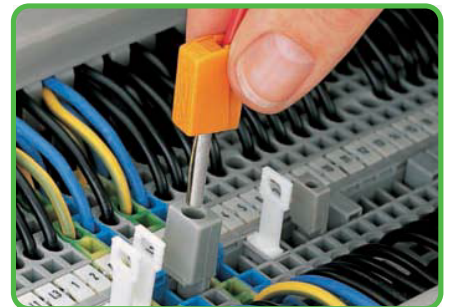

Testing with test plug.
Using 209-170 test plug adapter.



fine-stranded,
tip-bonded



fine-stranded,
with ferrule ❶
(gastight crimped)



fine-stranded,
with pin terminal
(gastight crimped)

Through/Ground Conductor and Ex Terminal Blocks 35 mm² 285 Series

CAGE CLAMP®

6 - 35 mm² AWG 8 - 2
 1000 V/8 kV/3 ① 600 V, 115 A^{II}
 I_N 125 A 600 V, 120 A^{III}
 Terminal block width 16 mm / 0.63 in
 23 mm / 0.91 in ②

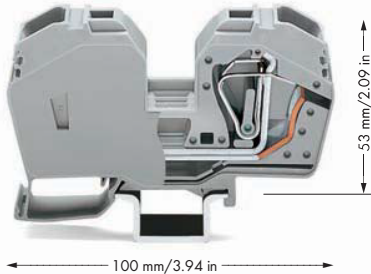

Terminating a 35 mm²/AWG 2 conductor.

- ① 1000 V = rated voltage
 8 kV = rated surge voltage
 3 = pollution degree
 (also see Section 14)

② Strip length, see packaging or instructions.

③ Suitable for Ex e II applications
 6 mm² - 35 mm²/AWG 8 - 2
 880 V, 85 A
 6 mm² - 25 mm²/AWG 8 - 4
 for ground conductor terminal blocks
 (also see Section 14)

Item No.	Pack. Unit
2-conductor through terminal block, with integrated end plate, to be used exclusively on DIN 35 x 15 rail	
gray 285-635	15
blue 285-634	15
light gray ② 285-992 ③	15
2-conductor ground terminal block, with integrated end plate, to be used exclusively on DIN 35 x 15 rail	
green-yellow 285-637	15
green-yellow ② 285-637/999-950 ③	15
285 Series Accessories Appropriate marking systems: WMB/Miniature WSB/WFB	
Adjacent jumper, insulated, I _N 85 A	
gray 285-435	50 (2x25)
Step-down jumper, insulated, I _N 32 A	
gray 283-414	50 (2x25)
Protective warning marker, with high-voltage symbol, black, for 5 terminal blocks	
yellow 285-416	50 (2x25)
Finger guard, touchproof cover protects unused conductor entries	
yellow 285-401	100
Screwless end stop, for DIN 35 rail, 6 mm wide	
gray 249-116	100 (4x25)
Screwless end stop, for DIN 35 rail, 10 mm wide	
gray 249-117	50 (2x25)

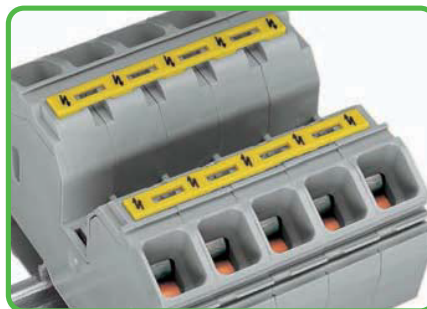

Protective warning markers inserted into the operating slots.

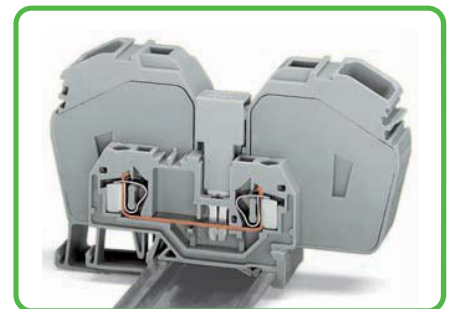

Commoning a 285 Series terminal block (35 mm²/AWG 2) with a 281 Series terminal block (4 mm²/AWG 12) using a 283-414 step-down jumper. Step-down jumpers are simply pushed down for full insertion, similar to adjacent jumpers.

Note:

The total current flowing shall not exceed the rating of the step-down jumper.



Inserting a finger guard seals unused conductor entries.

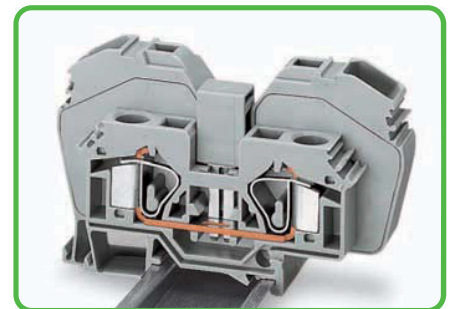

285 Series terminal blocks can be commoned with 283 Series terminal blocks: 285-635 or 285-634 with 283-601 or 283-604 (for terminal blocks with side marking, see www.wago.com). Jumper required: 285-435.

Please note that the nominal current of adjacent jumper shall not exceed 63A.