

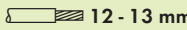





# Fuse Terminal Blocks for Mini-Automotive Blade-Style Fuses 6 mm<sup>2</sup> 282 Series



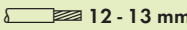

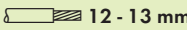
<b>0.2 - 6 mm<sup>2</sup></b> 400 V/6 kV/3 ① ② I <sub>N</sub> 25 A (30 A) Terminal block width 8 mm / 0.315 in  12 - 13 mm / 0.49 in ③	<b>AWG 24 - 10</b> 12 V, 30 A  24 V, 12 A 	<b>0.2 - 6 mm<sup>2</sup></b> 400 V/6 kV/3 ① ② I <sub>N</sub> 25 A (30 A) Terminal block width 8 mm / 0.315 in  12 - 13 mm / 0.49 in ③	<b>AWG 24 - 10</b> 24 V, 30 A  	<b>0.2 - 6 mm<sup>2</sup></b> 400 V/6 kV/3 ① ② I <sub>N</sub> 25 A (30 A) Terminal block width 8 mm / 0.315 in  12 - 13 mm / 0.49 in ③	<b>AWG 24 - 10</b> 600 V, 30 A  24 V, 30 A 
-------------------------------------------------------------------------------------------------------------------------------------------------------------------------------------------------------------------------------------	--------------------------------------------------------------------------------------------------------------------------------------------------------------------------------------------------------------------	-------------------------------------------------------------------------------------------------------------------------------------------------------------------------------------------------------------------------------------	------------------------------------------------------------------------------------------------------------------------	---------------------------------------------------------------------------------------------------------------------------------------------------------------------------------------------------------------------------------------	-------------------------------------------------------------------------------------------------------------------------------------------------------------------------------------------------------------------------

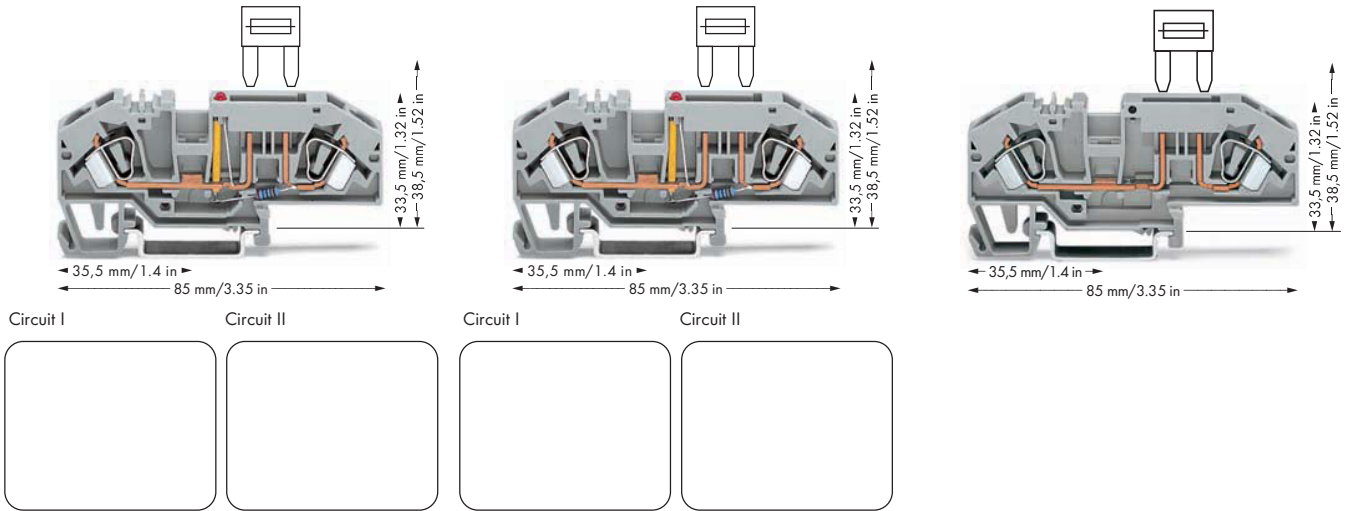

Item No.	Pack. Unit	Item No.	Pack. Unit	Item No.	Pack. Unit
<b>2-conductor fuse terminal block for mini-automotive blade-style fuses,</b> 12V, with test point, with blown fuse indication by LED, LED power consumption: 4.8mA, gray Nominal voltage and current are given by the LED or fuse. Blade-style fuses, please note touchproof protection for 42V and higher. ● Circuit I <b>282-698/281-429</b> 25 ● Circuit II <b>282-698/281-449</b> 25		<b>2-conductor fuse terminal block for mini-automotive blade-style fuses,</b> 24V, with test point, with blown fuse indication by LED, LED power consumption: 4.8mA, gray Nominal voltage and current are given by the LED or fuse. Blade-style fuses, please note touchproof protection for 42V and higher. ● Circuit I <b>282-698/281-413</b> 25 ● Circuit II <b>282-698/281-434</b> 25		<b>2-conductor fuse terminal block for mini-automotive blade-style fuses,</b> with test point, without blown fuse indication, Nominal voltage and current are given by the fuse. Blade-style fuses, please note touchproof protection for 42V and higher. ● gray <b>282-696</b> 25	
<b>Other terminal blocks with the same profile:</b> Through <b>282-699</b> Page 220		<b>Other terminal blocks with the same profile:</b> Through <b>282-699</b> Page 220		<b>Other terminal blocks with the same profile:</b> Through <b>282-699</b> Page 220	
<b>Blade-style fuses</b> (not offered by WAGO)					
<b>Excess-current circuit-breaker, thermal</b> (not offered by WAGO)					
<b>Recommended excess-current circuit-breakers from ETA</b>					

### Accessories for Fuse Terminal Blocks

Appropriate marking system: WMB  
(see Section 13)

<b>End plate, 2 mm thick</b>  orange <b>282-333</b> 100 (4x25) gray <b>282-334</b> 100 (4x25)	<b>Screwless end stop,</b> for DIN 35 rail, 6 mm wide gray <b>249-116</b> 100 (4x25)
<b>Adjacent jumper, insulated,</b> I <sub>N</sub> 41 A  gray <b>282-402</b> 100 (4x25)	<b>Screwless end stop,</b> for DIN 35 rail, 10 mm wide gray <b>249-117</b> 50 (2x25)
<b>Alternate jumper, insulated,</b> I <sub>N</sub> 41 A  gray <b>282-409</b> 100 (4x25)	
<b>Test plug adapter, 8.3 mm wide,</b> for terminal blocks 1.5 - 10 mm <sup>2</sup> , for test plug 4 mm Ø  gray <b>209-170</b> 50 (2x25)	

For list of approvals and user guide, see pages 634 to 637.

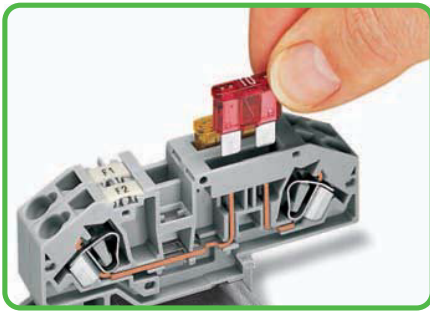

Inserting a fuse.

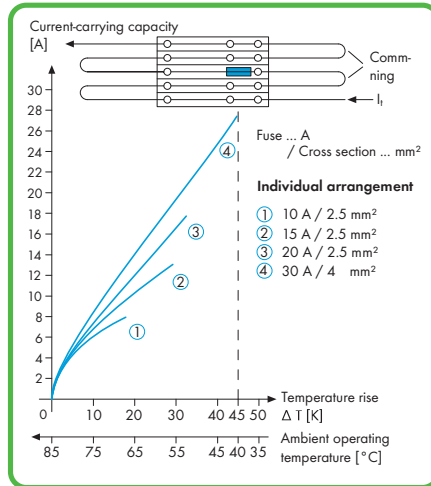

Diagram: Individual arrangement

- ① 400 V = rated voltage  
6 kV = rated surge voltage  
3 = pollution degree  
(also see Section 14)

- ② Electrical ratings are given by the fuse  
(also see pages 234 – 235).

- ③ Strip length, see packaging or instructions.



Blown fuse indication by LED.

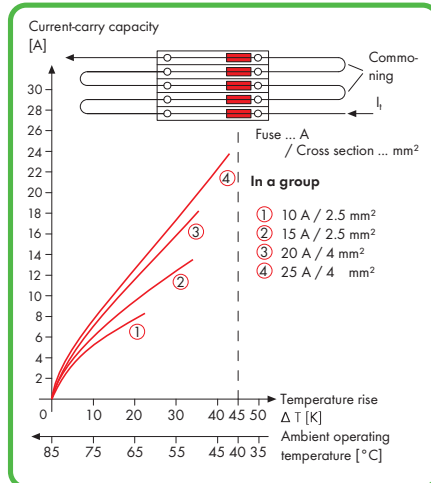
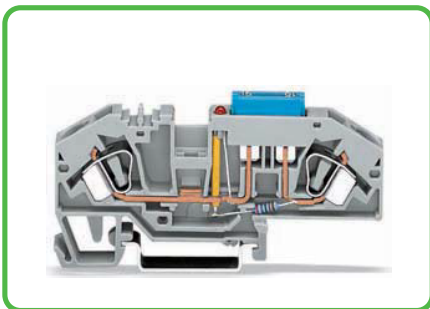

Diagram: Block arrangement

### Information from the mini-automotive blade-type fuse manufacturers

Derating $T_{amb} / ^\circ C$	%	$F_T$
- 25	14	0.877
- 20	13	0.885
- 15	12	0.893
- 10	11	0.901
- 5	10	0.909
0	9	0.917
5	8	0.926
10	6	0.943
15	4	0.962
20	2	0.980
23	0	1.000
30	- 2	1.020
35	- 4	1.042
40	- 6	1.064
45	- 8	1.087
50	- 10	1.111
55	- 13	1.149
60	- 16	1.190
65	- 19	1.235
70	- 22	1.282



2-conductor fuse terminal block with mini-automotive blade-style fuse.

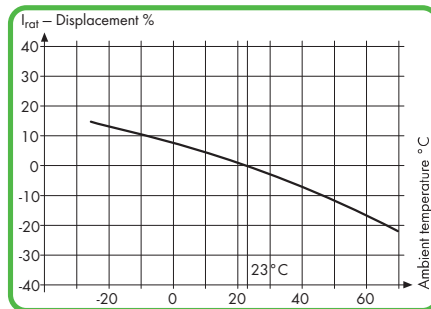

The rated currents of the fuse cartridges are defined differently in international standards.

Due to the different current rating definitions, the recommended current-carrying permanent capacity of the fuses is max. 80% of their rated current according to DIN 72581 part 3 (for an ambient operating temperature of 23°C).

Selecting the correct fuse cartridge is important for product safety within applications, as well as for fuse cartridge service life and operational reliability of the fuse cartridges. Fuse cartridges can operate perfectly as protection (break-off point) if they are properly selected and are used in accordance with manufacturer specifications.

With regard to the product safety, it is in general necessary to test fuse cartridges under normal conditions and operational failures within your application.