

# Rail-Mounted Terminal Blocks 279 to 285 Series and 880 Series

## Assembly



By snapping a ground conductor terminal block onto the carrier rail, a direct electrical connection is automatically made to the rail.

## Assembly

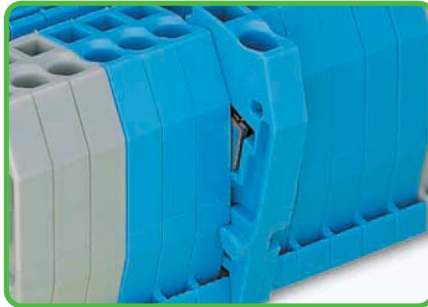

Quick assembly keys prevent reverse mounting.

## Removal

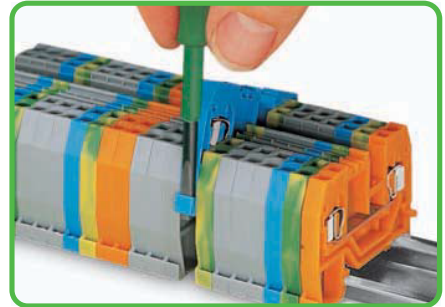

Removing a terminal block from the assembly.

## Commoning

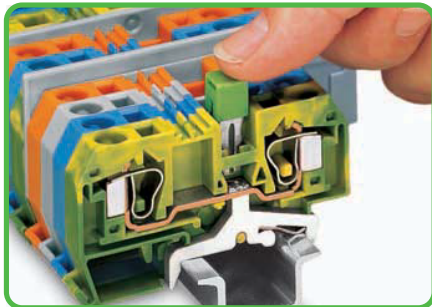

Commoning ground conductor terminal blocks with through terminal blocks is possible in one direction only (via rear side of terminal block) using adjacent jumpers. In addition to the required marking of these blocks, use yellow-green adjacent jumpers.

## Commoning with step-down jumpers

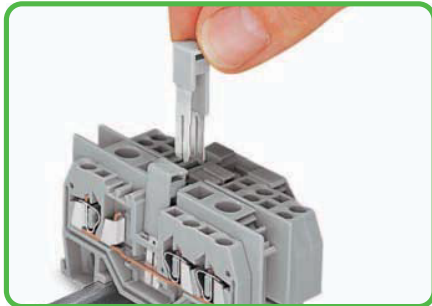

Commoning terminal blocks of different sizes - step down.  
For application notes, see page 178.

## Commoning

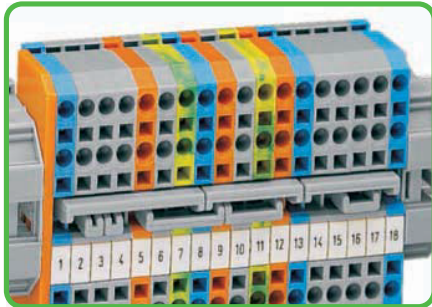

Staggered jumpers for sophisticated circuit requirements. Push jumpers down firmly until fully inserted. For additional notes, see page 201.

According to EN 60947-7-2 (VDE 0611, part 3), steel carrier rails shall not be used for PEN applications

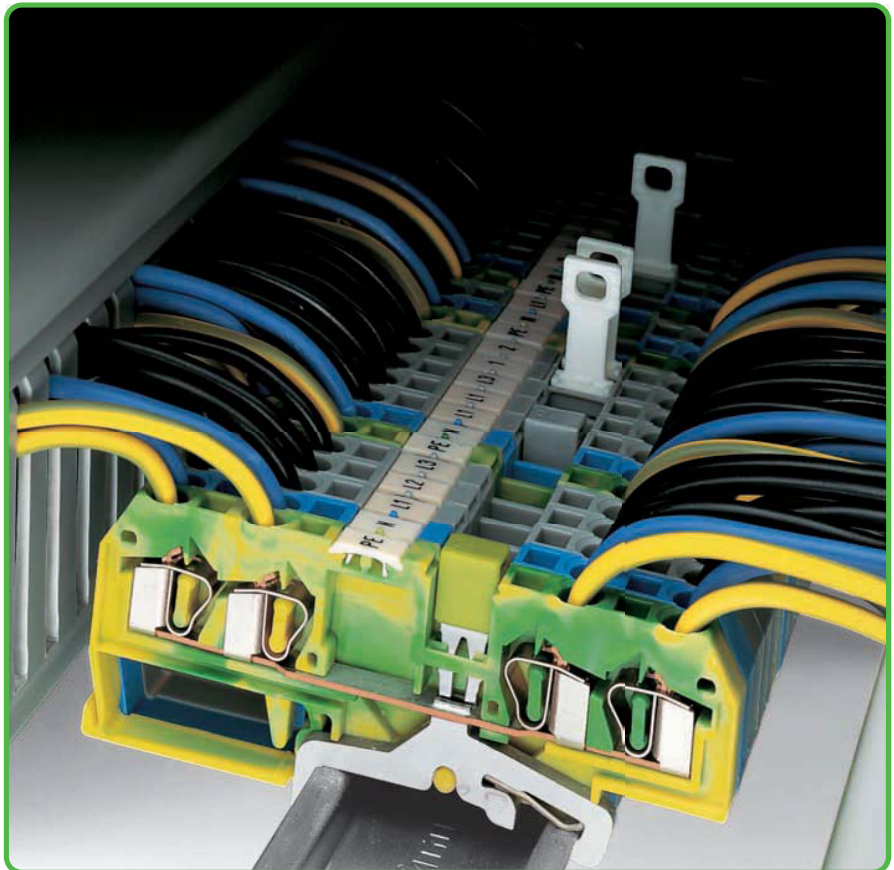

## Testing - 880 Series

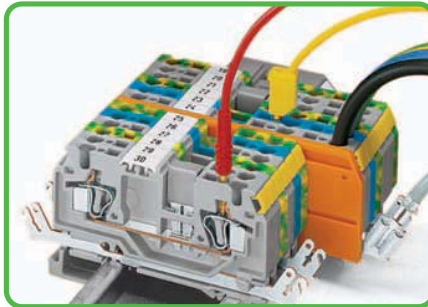

880 Series terminal blocks have an additional test slot for 2 mm Ø or 2.3 mm Ø test plugs.

## Protective warning marker

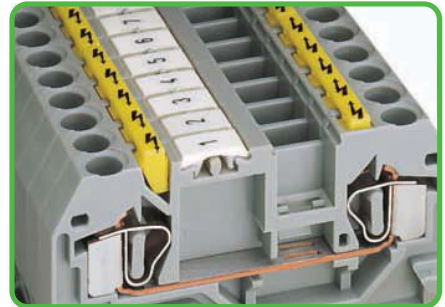

Protective warning markers inserted into the operating slots.

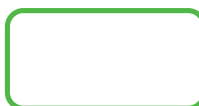

**CAGE CLAMP®**  
clamps the following  
copper conductors:\*

solid

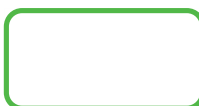

stranded

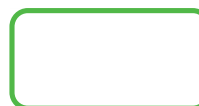

fine-stranded,  
also with tinned  
single strands

\* For aluminum conductors, see notes in Section 14.

- Description and Handling -

CAGE CLAMP® connection

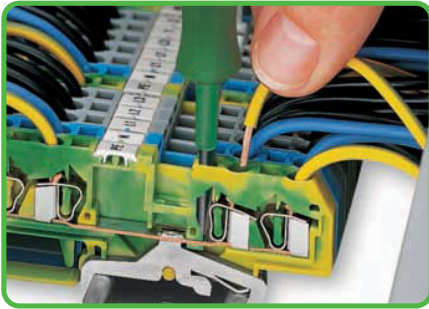

Conductor termination

CAGE CLAMP® connection

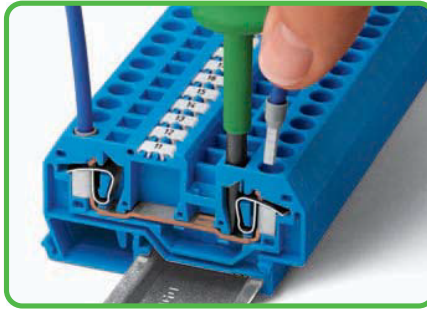

Conductor termination

❶ When using ferruled conductors, it is necessary to use a terminal block one size larger than the nominal cross section of the wire.

Testing

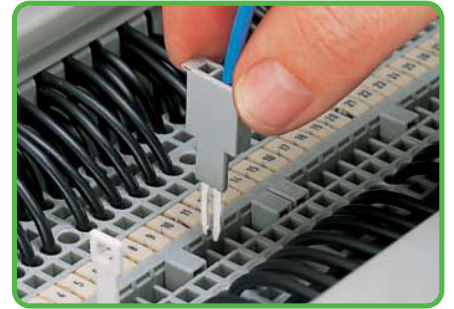

Testing with test plug.  
Test plug fitted with CAGE CLAMP®.

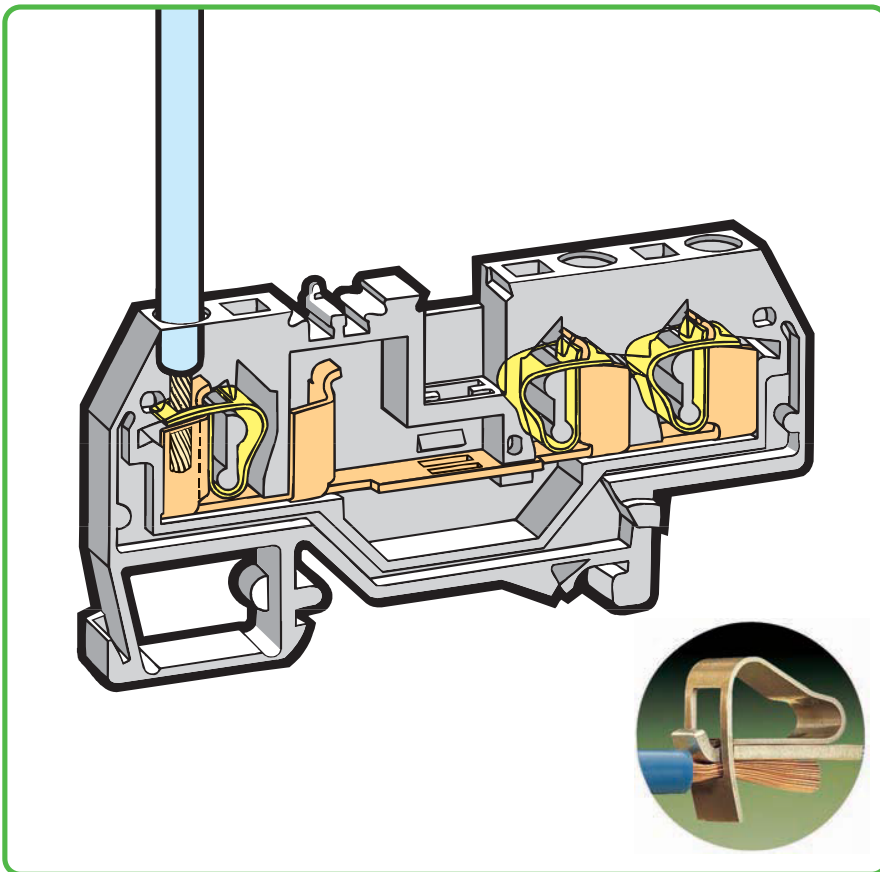

Testing

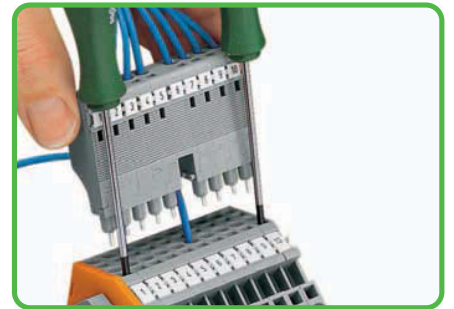

L-type test plug modules fitted with CAGE CLAMP®.  
For application notes, see page 194.

Testing

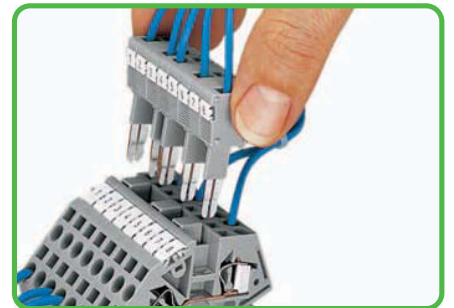

B-type test plug modules fitted with CAGE CLAMP®.  
For application notes, see page 195.

Marking



Marking with WMB Multi marking system.  
For additional systems, see Section 13.

Insulation stop

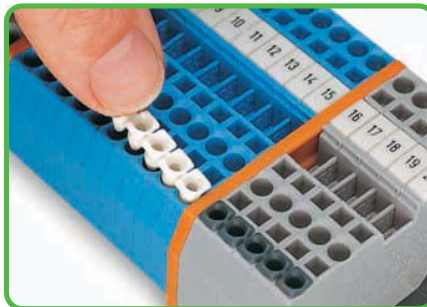

Insertion of insulation stop.  
For application notes, see page 199.

Testing

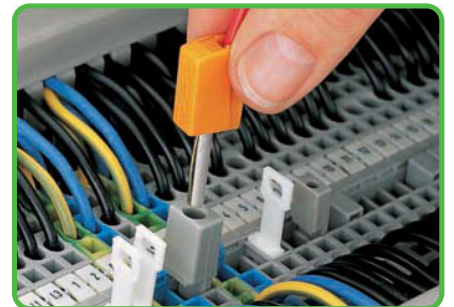

Testing with test plug.  
Using 209-170 test plug adapter.

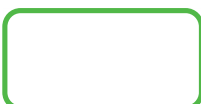

fine-stranded,  
tip-bonded

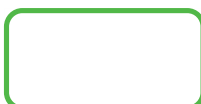

fine-stranded,  
with ferrule ❶  
(gastight crimped)



fine-stranded,  
with pin terminal  
(gastight crimped)

# Through/Ground Conductor and Ex Terminal Blocks 6 mm<sup>2</sup> 282 Series



<b>0.2 - 6 mm<sup>2</sup></b> 800 V/8 kV/3 ① I <sub>N</sub> 41 A Terminal block width 8 mm / 0.315 in 12 - 13 mm / 0.49 in ②	<b>AWG 24 - 10</b> 600 V, 30 A ④ 600 V, 40 A ⑤ Terminal block width 8 mm / 0.315 in 12 - 13 mm / 0.49 in ②	<b>0.2 - 6 mm<sup>2</sup></b> 800 V/8 kV/3 ① I <sub>N</sub> 41 A Terminal block width 8 mm / 0.315 in 12 - 13 mm / 0.49 in ②	<b>AWG 24 - 10</b> 600 V, 30 A ④ 600 V, 40 A ⑤ Terminal block width 8 mm / 0.315 in 12 - 13 mm / 0.49 in ②
--	--	--	--

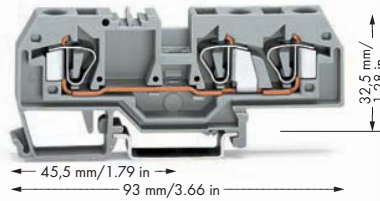
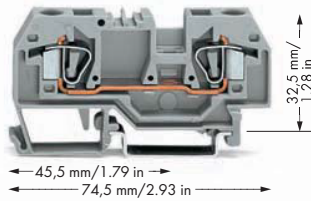

- ① 800 V = rated voltage  
8 kV = rated surge voltage  
3 = pollution degree  
(also see Section 14)
- ② Strip length, see packaging or instructions.
- ③ Suitable for Ex i applications
- ④ Suitable for Ex e II applications  
0.5 mm<sup>2</sup> - 6 mm<sup>2</sup>/AWG 20 - 10  
550 V, 39 A  
Jumper 35 A  
(also see Section 14)
- ⑤ See application notes for:  
Test plug module, page 197  
Banana plug, page 198  
Step-down jumper, pages 178 - 179

Item No.	Pack. Unit	Item No.	Pack. Unit
<b>2-conductor through terminal block</b>		<b>3-conductor through terminal block</b>	
gray 282-901	50	gray 282-681	25
blue 282-904 ③	50	blue 282-684 ③	25
orange 282-902	50	orange 282-682	25
light gray ⑤	50	light gray ⑤	50
<b>2-conductor ground terminal block</b>		<b>3-conductor ground terminal block</b>	
green-yellow 282-907	50	green-yellow 282-687	25
green-yellow ⑤	50	green-yellow ⑤	50



**Commoning with step-down jumpers**  
A step-down cover plate must be inserted between terminal blocks to be jumpered. Step-down jumper 284-414 commons 10/6 mm<sup>2</sup>/AWG 8/10 terminal blocks with 4/2.5/1.5 mm<sup>2</sup>/AWG 12/14/16 terminal blocks.

Step-down jumpers are simply pushed down for full insertion, similar to adjacent jumpers.

Item-Specific Accessories				Item-Specific Accessories			
<b>End and intermediate plate, 2.5 mm thick</b>				<b>End and intermediate plate, 2.5 mm thick</b>			
	orange	282-328	100 (4x25)		orange	282-339	100 (4x25)
	gray	282-325	100 (4x25)		gray	282-308	100 (4x25)
	light gray	282-330	100 (4x25)		light gray	282-341	100 (4x25)
<b>Separator, oversized, 2 mm thick</b>				<b>Separator, oversized, 2 mm thick</b>			
	orange	282-329	100 (4x25)		orange	282-340	100 (4x25)
	gray	282-326	100 (4x25)		gray	282-309	100 (4x25)
	light gray	282-331	100 (4x25)		light gray	282-342	100 (4x25)
<b>Cover plate, 1 mm thick</b>				<b>Cover plate, 1 mm thick</b>			
	gray	282-357	25		gray	282-358	25
	orange	282-367	25		orange	282-368	25



**Commoning with step-down jumpers**  
A step-down cover plate must be inserted between terminal blocks to be jumpered. Step-down jumper 284-413 commons 10/6 mm<sup>2</sup>/AWG 8/10 terminal blocks with 6/4 mm<sup>2</sup>/AWG 10/12 terminal blocks.

Step-down jumpers are simply pushed down for full insertion, similar to adjacent jumpers.

282 Series Accessories			
Appropriate marking systems: WMB/WFB (see Section 13)			
	<b>Ex e/Ex i separator, orange, 3 mm thick</b>	120 mm	209-191 50 (2x25)
	<b>Step-down jumper, insulated, I<sub>N</sub> 30 A</b>	gray	284-413 50 (2x25)
	<b>Adjacent jumper, insulated, I<sub>N</sub> 41 A</b>	gray	282-402 100 (4x25)
	<b>Test plug adapter, 8.3 mm wide, for terminal blocks 1.5 - 10 mm<sup>2</sup>, for test plug 4 mm Ø</b>	gray	209-170 50 (2x25)
	<b>Alternate jumper, insulated, I<sub>N</sub> 41 A</b>	gray	282-409 100 (4x25)
	<b>Banana plug, for socket 4 mm Ø, color mixed</b>		215-111 50
	<b>Protective warning marker, with high-voltage symbol, black, for 5 terminal blocks</b>	yellow	282-415 100 (4x25)
	<b>Step-down jumper, insulated, I<sub>N</sub> 15 A</b>	gray	284-414 50 (2x25)
	<b>B-type test plug module, can be snapped together, 8 mm wide</b>	gray	709-310 100 (4x25)
	<b>B-type spacer module, can be snapped together, 8 mm wide</b>	gray	709-311 100 (4x25)

Note:  
**The total current flowing shall not exceed the rating of the step-down jumper.**