

# Rail-Mounted Terminal Blocks 279 to 285 Series and 880 Series

## Assembly



By snapping a ground conductor terminal block onto the carrier rail, a direct electrical connection is automatically made to the rail.

## Assembly

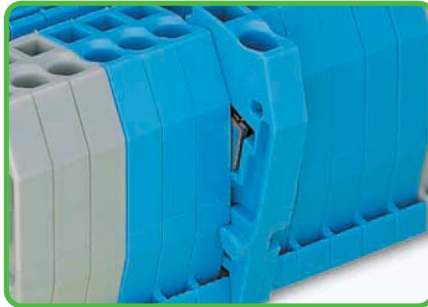

Quick assembly keys prevent reverse mounting.

## Removal

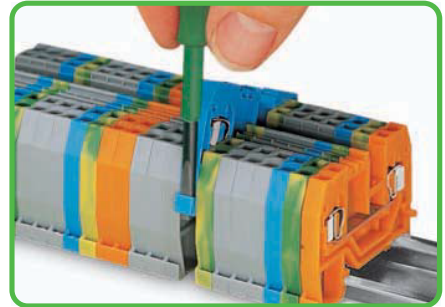

Removing a terminal block from the assembly.

## Commoning

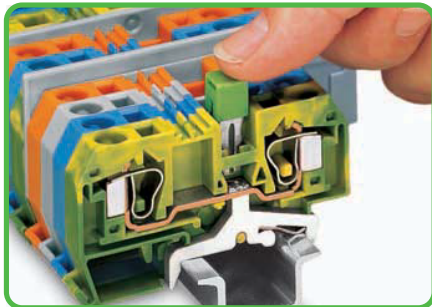

Commoning ground conductor terminal blocks with through terminal blocks is possible in one direction only (via rear side of terminal block) using adjacent jumpers. In addition to the required marking of these blocks, use yellow-green adjacent jumpers.

## Commoning with step-down jumpers

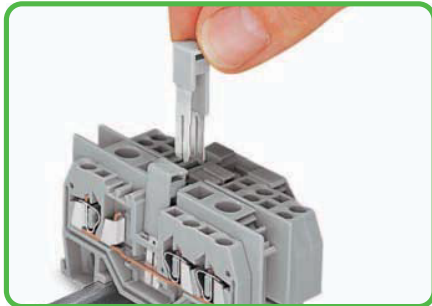

Commoning terminal blocks of different sizes - step down.  
For application notes, see page 178.

According to EN 60947-7-2 (VDE 0611, part 3), steel carrier rails shall not be used for PEN applications

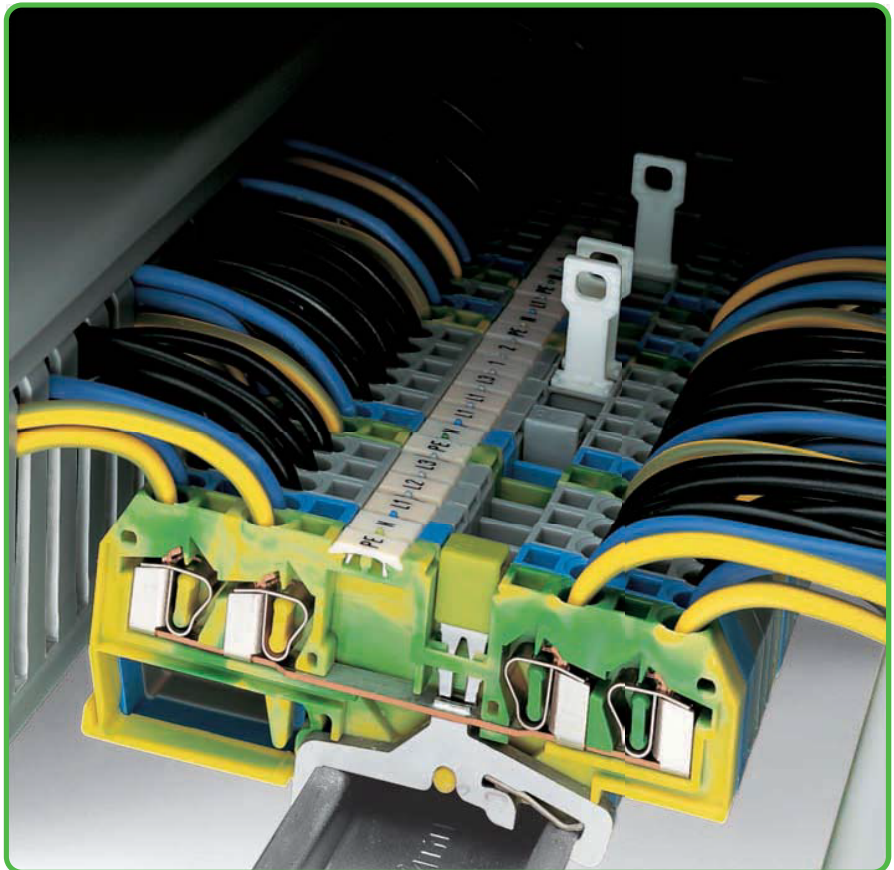

## Commoning

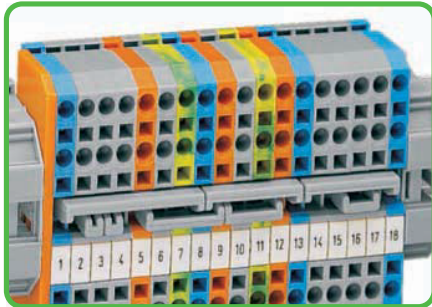

Staggered jumpers for sophisticated circuit requirements. Push jumpers down firmly until fully inserted. For additional notes, see page 201.

## Testing - 880 Series

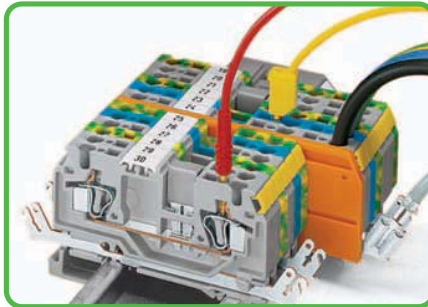

880 Series terminal blocks have an additional test slot for 2 mm Ø or 2.3 mm Ø test plugs.

## Protective warning marker

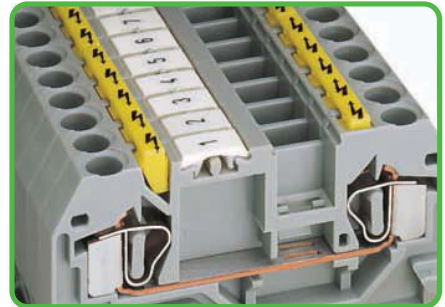

Protective warning markers inserted into the operating slots.

**CAGE CLAMP®**  
clamps the following  
copper conductors:\*

solid

stranded

fine-stranded,  
also with tinned  
single strands

\* For aluminum conductors, see notes in Section 14.

- Description and Handling -

CAGE CLAMP® connection

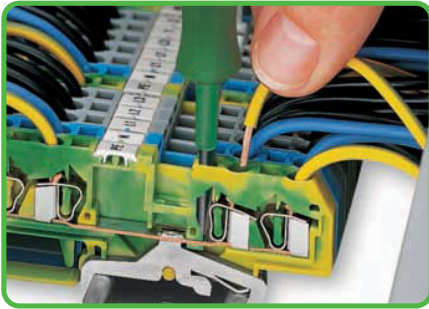

Conductor termination

CAGE CLAMP® connection

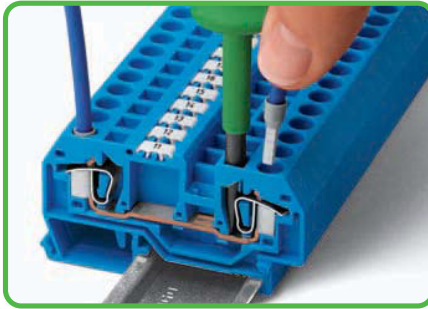

Conductor termination

❶ When using ferruled conductors, it is necessary to use a terminal block one size larger than the nominal cross section of the wire.

Testing

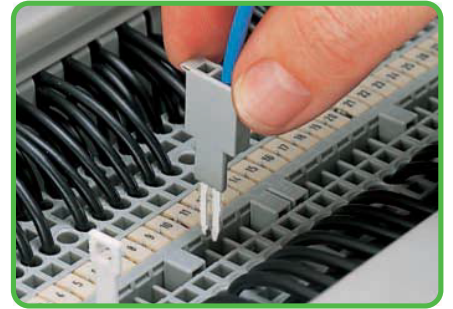

Testing with test plug.  
Test plug fitted with CAGE CLAMP®.

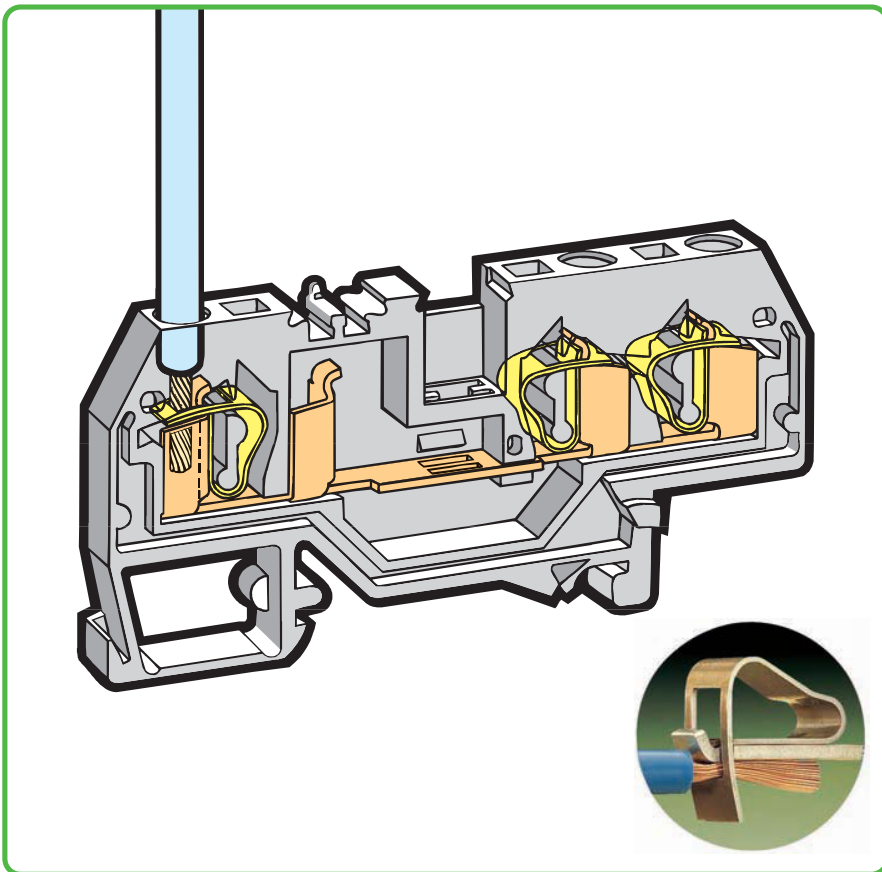

Testing

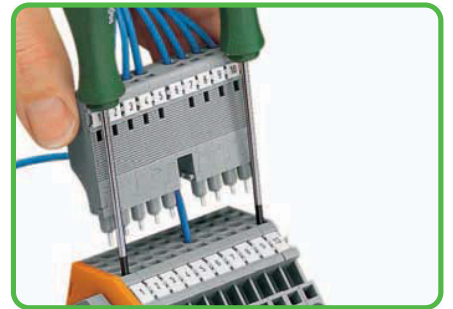

L-type test plug modules fitted with CAGE CLAMP®.  
For application notes, see page 194.

Testing

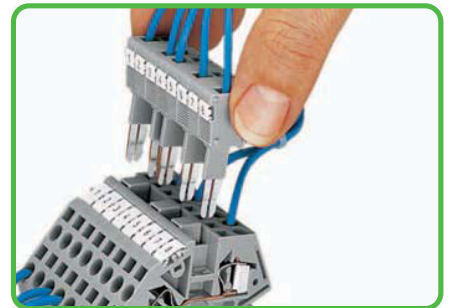

B-type test plug modules fitted with CAGE CLAMP®.  
For application notes, see page 195.

Marking



Marking with WMB Multi marking system.  
For additional systems, see Section 13.

Insulation stop

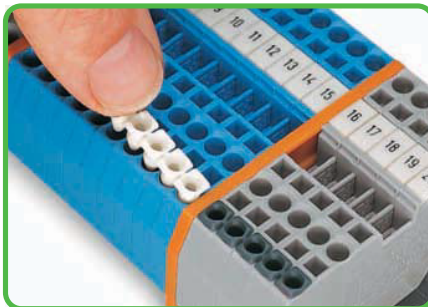

Insertion of insulation stop.  
For application notes, see page 199.

Testing

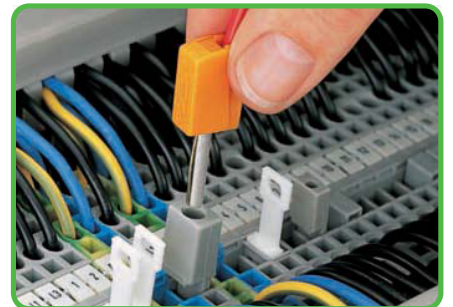

Testing with test plug.  
Using 209-170 test plug adapter.

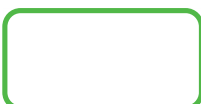

fine-stranded,  
tip-bonded

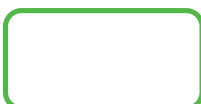

fine-stranded,  
with ferrule ❶  
(gastight crimped)



fine-stranded,  
with pin terminal  
(gastight crimped)

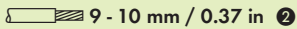
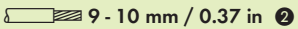
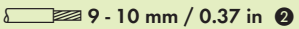

# Through/Ground Conductor/Shield and Ex Terminal Blocks 4 mm<sup>2</sup> 281 Series

<b>0.08 - 4 mm<sup>2</sup></b> 800 V/8 kV/3 ① I <sub>N</sub> 32 A  Terminal block width 6 mm / 0.236 in  9 - 10 mm / 0.37 in ②	<b>AWG 28 - 12</b> 600 V, 20 A ③ 600 V, 25 A ④	<b>0.08 - 4 mm<sup>2</sup></b> 800 V/8 kV/3 ① I <sub>N</sub> 32 A  Terminal block width 6 mm / 0.236 in  9 - 10 mm / 0.37 in ②	<b>AWG 28 - 12</b> 600 V, 20 A ③ 600 V, 25 A ④	<b>0.08 - 4 mm<sup>2</sup></b> 800 V/8 kV/3 ① I <sub>N</sub> 26 A  Terminal block width 6 mm / 0.236 in  9 - 10 mm / 0.37 in ②	<b>AWG 28 - 12</b> 600 V, 20 A ③ 600 V, 25 A ④
--	--	--	--	--	--

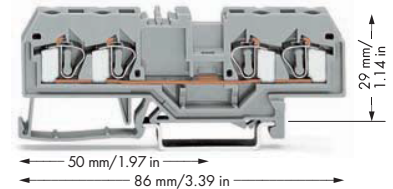
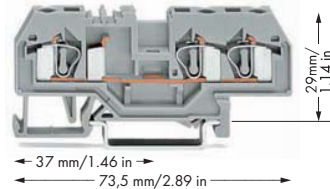
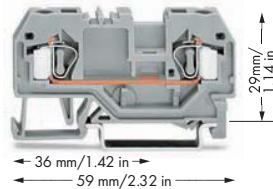

Item No.	Pack. Unit	Item No.	Pack. Unit	Item No.	Pack. Unit
<b>2-conductor through terminal block</b>		<b>3-conductor through terminal block</b>		<b>4-conductor through terminal block</b>	
gray 281-901	50	gray 281-681	50	gray 281-652	50
blue 281-904 ③	50	blue 281-684 ③	50	blue 281-654 ③	50
orange 281-902	50	orange 281-678	50	orange 281-653	50
red 281-903	50	red 281-679	50	red 281-663	50
black 281-905	50	black 281-685	50	black 281-664	50
yellow 281-906	50	yellow 281-686	50	yellow 281-668	50
light gray ⑤	281-992 ④	50	light gray ⑤	281-993 ④	50
<b>2-conductor ground terminal block</b>		<b>3-conductor ground terminal block</b>		<b>4-conductor ground terminal block</b>	
green-yellow 281-907	50	green-yellow 281-687	50	green-yellow 281-657	50
green-yellow ⑤	281-907/999-950 ④	50	green-yellow ⑤	281-687/999-950 ④	50
				<b>4-conductor shield terminal block</b>	
				white 281-658	50
<b>Other terminal blocks with the same profile:</b>		<b>Other terminal blocks with the same profile:</b>		<b>Other terminal blocks with the same profile:</b>	
Diode 281-915/281-410	Page 258	Diode 281-673/281-410	Page 258	Diode 281-665/281-410	Page 258
Disconnect 281-912	Page 208	Disconnect 281-683	Page 208	Disconnect 281-659	Page 208
Carrier 281-916	Page 230	Carrier 281-610	Page 230	Disc., test & meas. 281-666	Page 208
				Carrier 281-656	Page 230
<b>Item-Specific Accessories</b>		<b>Item-Specific Accessories</b>		<b>Item-Specific Accessories</b>	
<b>End and intermediate plate, 2.5 mm thick</b>		<b>End and intermediate plate, 2.5 mm thick</b>		<b>End and intermediate plate, 2.5 mm thick</b>	
orange 281-329	100 (4x25)	orange 281-326	100 (4x25)	orange 281-335	100 (4x25)
gray 281-328	100 (4x25)	gray 281-324	100 (4x25)	gray 281-334	100 (4x25)
light gray 281-349	100 (4x25)	light gray 281-355	100 (4x25)	light gray 281-345	100 (4x25)
<b>Separator, oversized, 2 mm thick</b>		<b>Separator, oversized, 2 mm thick</b>		<b>Separator, oversized, 2 mm thick</b>	
orange 281-331	100 (4x25)	orange 281-346	100 (4x25)	orange 281-339	100 (4x25)
gray 281-330	100 (4x25)	gray 281-344	100 (4x25)	gray 281-338	100 (4x25)
light gray 281-350	100 (4x25)	light gray 281-356	100 (4x25)	light gray 281-347	100 (4x25)
<b>Ex e/Ex i separator, orange, 3 mm thick</b>		<b>Ex e/Ex i separator, orange, 3 mm thick</b>		<b>Ex e/Ex i separator, orange, 3 mm thick</b>	
120 mm 209-191	50 (2x25)	120 mm 209-191	50 (2x25)	120 mm 209-191	50 (2x25)
90 mm 209-190	50 (2x25)				
				<b>Cover plate, 1 mm thick</b>	
				gray 284-336	100
				orange 284-346	100

## 281 Series Accessories

Appropriate marking systems: WMB/WFB (see Section 13)

<b>Insulation stop, ⑤</b> 5 pcs/strip, 0.08 - 0.2 mm <sup>2</sup> "s" (0.14 mm <sup>2</sup> "Fst") white 281-470 200 (8x25)	<b>Insulation stop, ⑤</b> 5 pcs/strip, 0.25 - 0.5 mm <sup>2</sup> light gray 281-471 200 (8x25)	<b>Insulation stop, ⑤</b> 5 pcs/strip, 0.25 - 1.5 mm <sup>2</sup> dark gray 281-472 200 (8x25)
--	--	---