

Fuse Disconnect Terminal Blocks with Pivoting Fuse Holder, for Miniature Metric Fuses, 281 Series

Blown fuse indication



Blown fuse indication by LED or neon lamp.

Fuse replacement



Before replacing the fuse, pivot the fuse holder in the locked open position.

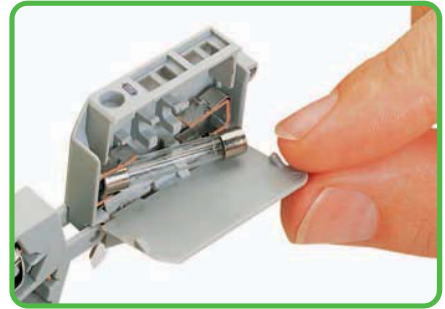

One end of the fuse is automatically ejected from the holder when opening the cover.

CAGE CLAMP® connection

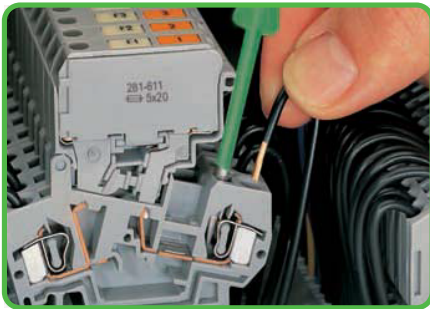

Conductor termination

Commoning

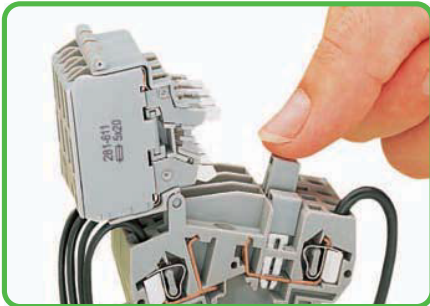

Distribution of current to several fuse-protected circuits via insulated touchproof jumpers.

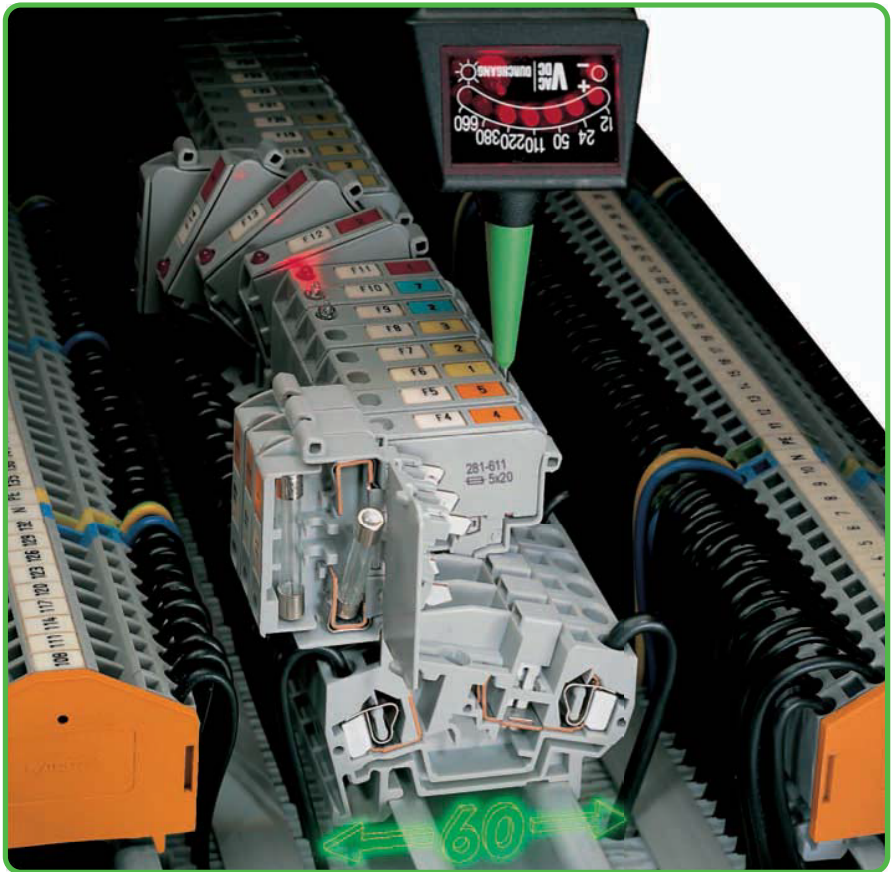

Testing

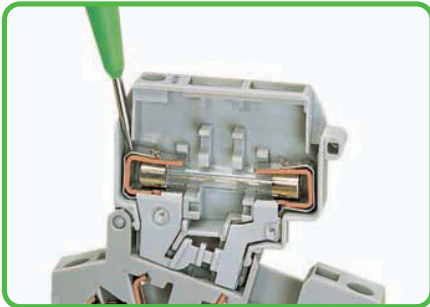

Voltage test, either at input or output with fuse holder in closed position (live).

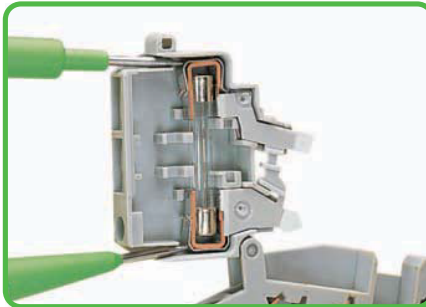

Through test with fuse holder in open position (no voltage).



Voltage test at input in the test slot of the current bar.

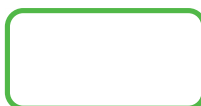

CAGE CLAMP® clamps the following copper conductors:*

solid

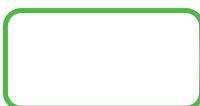

stranded

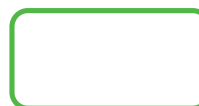

fine-stranded, also with tinned single strands

* For aluminum conductors, see notes in Section 14.

- Description and Handling -

Fuse replacement (continued)



The fuse can be easily removed by hand.

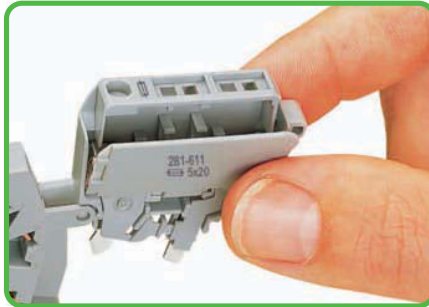

Insert new fuse snap the cover closed.

Spare fuse

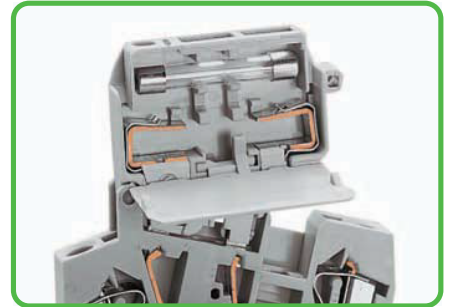

Storage of spare fuse (fuse holder without blown fuse indication).

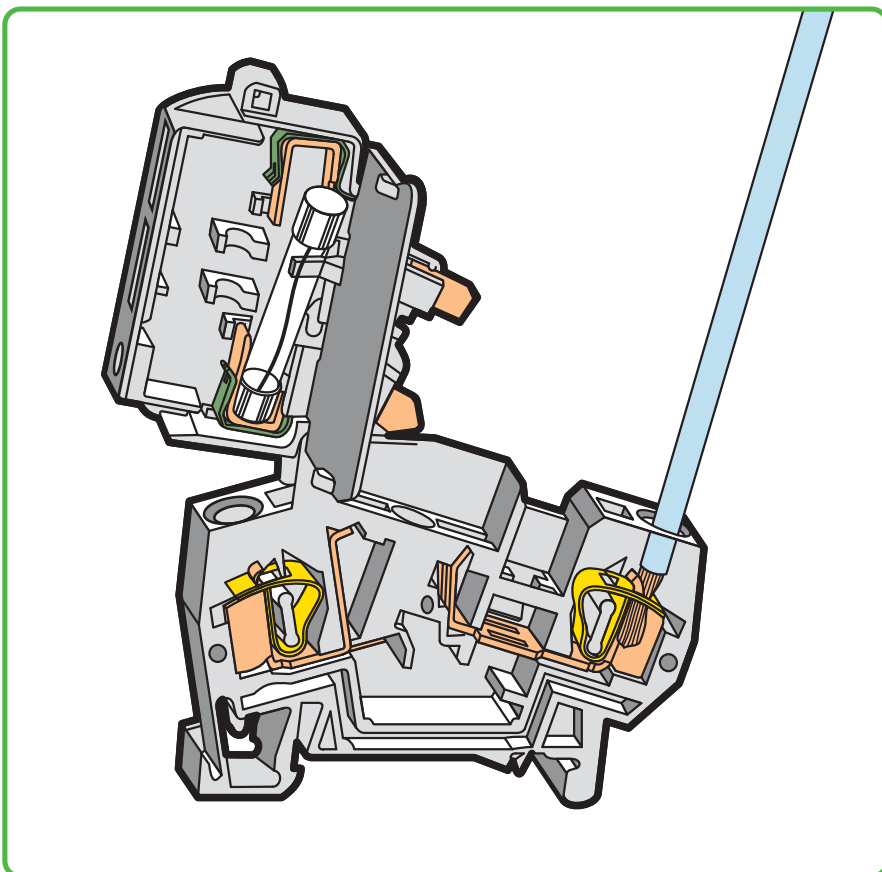

Touchproof protection



"Touchproof" protection in all positions of the fuse holder.

Locked position



Fuse holder will remain safely locked open in vertical assemblies.

Testing (continued)



Testing voltage at the output via separate test slot.

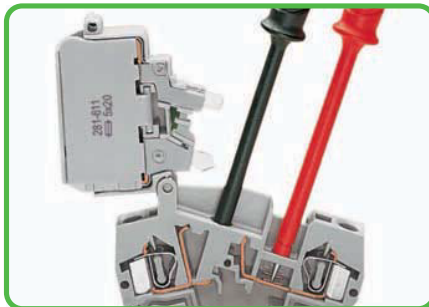

Current measuring between jumper slot and separate test slot.

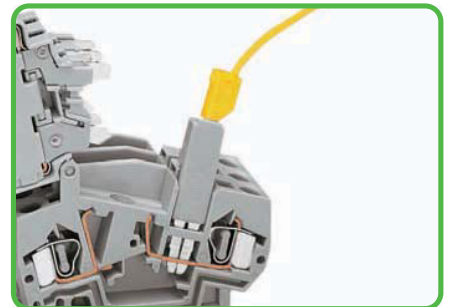

Voltage testing at input via 280-404 test plug adapter (shown) or 281-407 test plug.



fine-stranded,
tip-bonded



fine-stranded,
with ferrule ①
(gastight crimped)



fine-stranded,
with pin terminal
(gastight crimped)

① When using ferrules, the max. conductor cross section accommodated is one size smaller than max. rating of terminal block.



A spacer is standard equipment for 10 mm/0.394 in wide fuse terminal blocks. At the end of an assembly, or if there is **no** adjacent fuse terminal block, an end or intermediate plate must be used.

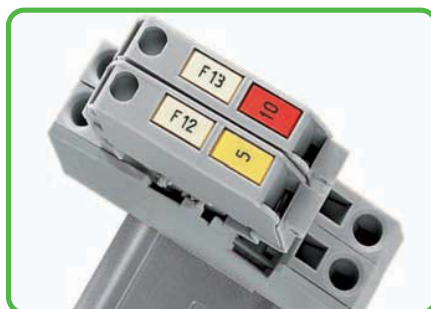

Two marker slots each per fuse holder are available for individual WMB Multi marking. (example: 8 mm/0.315 in terminal blocks).

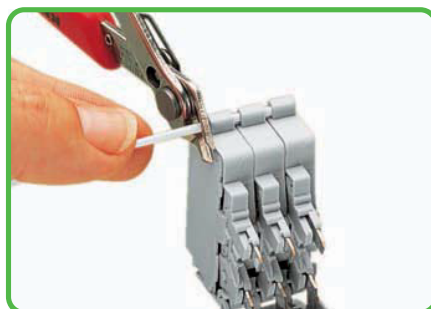











Ganging several fuse holders with a connecting strip (example: 8 mm/0.315 in terminal blocks).

- ❶ 800 V = rated voltage
8 kV = rated surge voltage
3 = pollution degree
(also see Section 14)
- ❷ Electrical ratings are given by the fuse
(also see pages 234 – 235).
- ❸ Strip length, see packaging or instructions.

281 Series Accessories

Appropriate marking system:
WMB (see Section 13)

End and intermediate plate, 2.5 mm thick			
	orange	281-309	100 (4x25)
	gray	281-311	100 (4x25)
Adjacent jumper, insulated, $I_N = I_N$ terminal block			
	gray	281-402	200 (8x25)
Collective carrier for adjacent jumpers			
	gray	209-100	50 (2x25)
Test plug adapter, 5 mm wide, for terminal blocks 1.5 - 4 mm ² , for 210-137 test plug 2.3 mm Ø			
	gray	280-404	100 (4x25)
Test plug,			
	with 500 mm cable, 2.3 mm Ø	yellow	210-137 50
Test plug adapter, 6 mm wide, with CAGE CLAMP®, for 0.08 - 2.5 mm ² I_N 24 A			
			281-407 100 (4x25)
Push-in type wire jumper, insulated, I_N 9 A, wire size 0.75 mm ²			
	L = 60 mm	249-125	10
	L = 110 mm	249-126	10
	L = 250 mm	249-127	10
Interlocking link, mechanically locks multiple links, 1 m/3'3" long			
	transparent	210-254	1
Screwless end stop, for DIN 35 rail, 6 mm wide			
	gray	249-116	100 (4x25)
Screwless end stop, for DIN 35 rail, 10 mm wide			
	gray	249-117	50 (2x25)

