

Rail-Mounted Terminal Blocks, Side-Entry 279 to 284 Series

Assembly

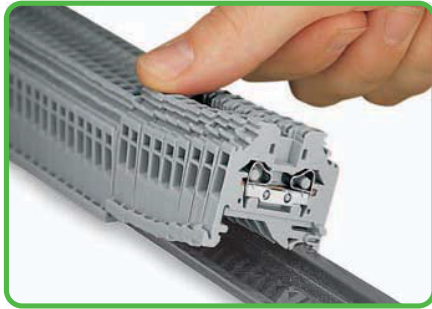

Snapping side-entry rail-mounted terminal blocks onto the carrier rail.



Quick assembly keys prevent reverse mounting.

Removal



Removal from the carrier rail.

CAGE CLAMP® connection

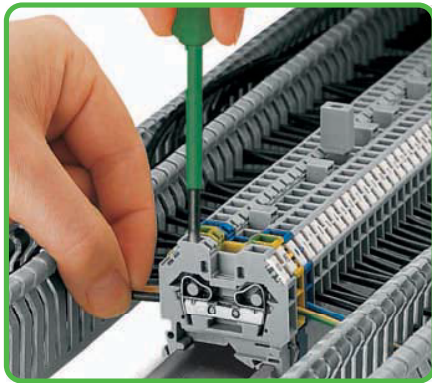

Conductor termination

Testing

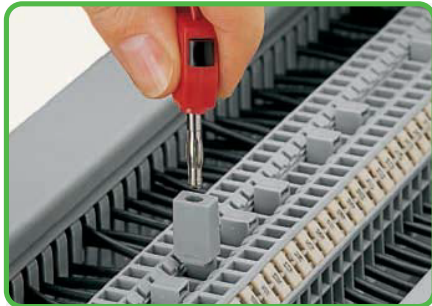

Testing with test plug adapter.

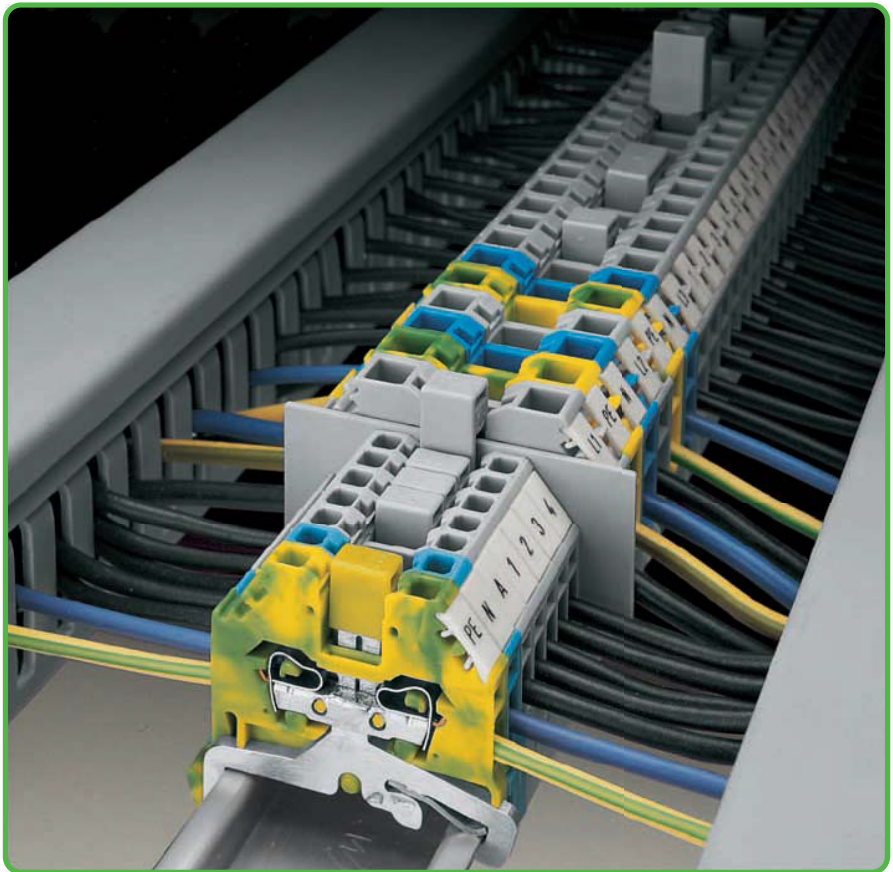

Commoning

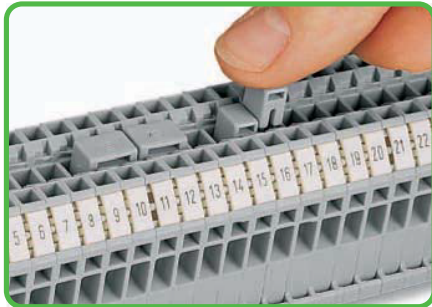

Commoning with adjacent jumpers.

Commoning with step-down jumpers

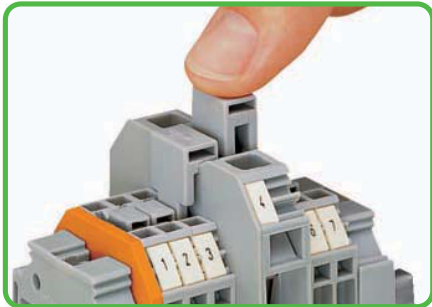

Commoning side-entry rail-mounted terminal blocks with step-down jumpers.

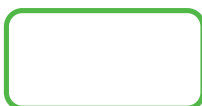

CAGE CLAMP®
clamps the following
copper conductors:*

solid

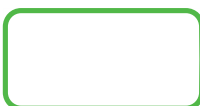

stranded

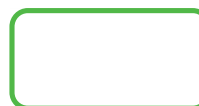

fine-stranded,
also with tinned
single strands

* For aluminum conductors, see notes in Section 14.

- Description and Handling -



Suitable for all DIN 35 rails.

Fuse terminal blocks

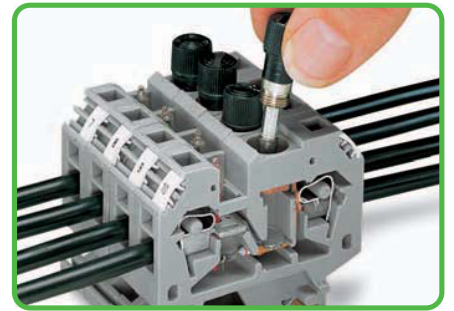

Replacing a fuse.

Disconnect terminal blocks for test and measurement

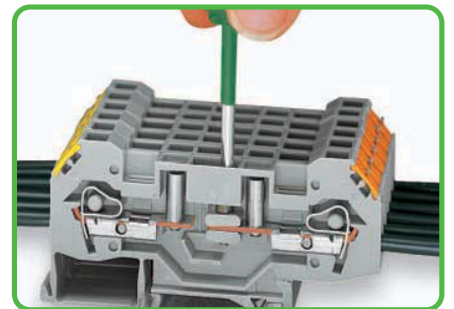

Shifting the disconnect slide link.

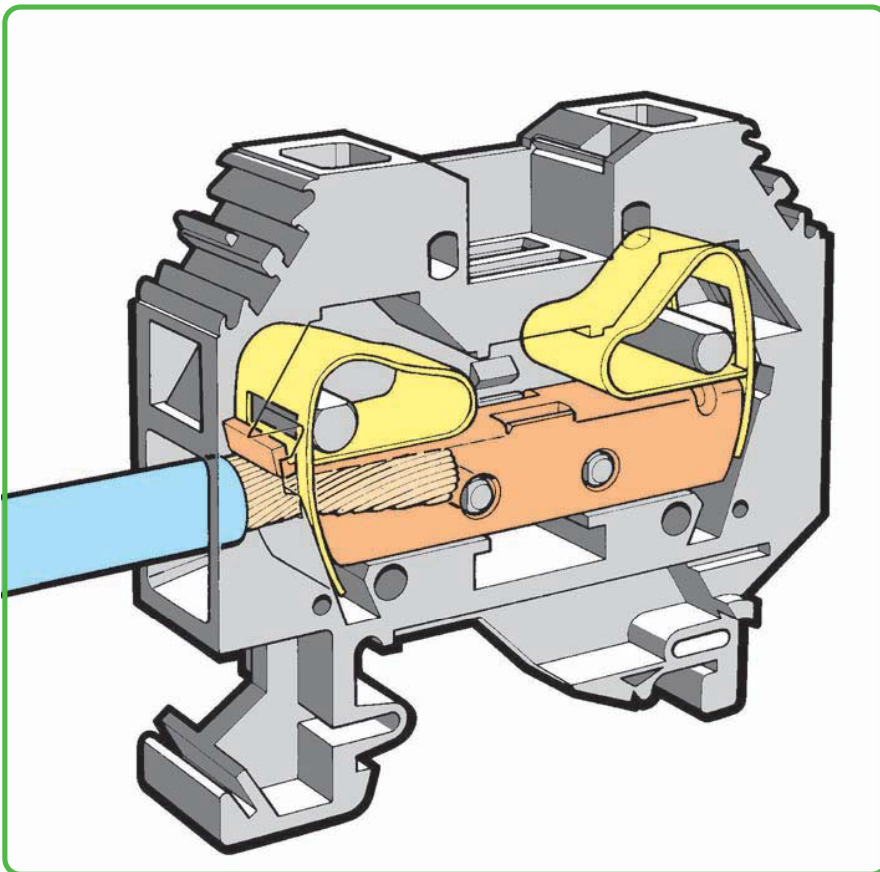

Marking



Marking with WMB Multi marking system.



fine-stranded, tip-bonded



fine-stranded, with ferrule ❶ (gaslight crimped)

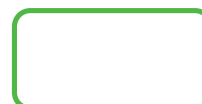

fine-stranded, with pin terminal (gaslight crimped)

❶ When using ferruled conductors, it is necessary to use a terminal block one size larger than the nominal cross section of the wire.

Through and Ground Conductor Terminal Blocks 1.5 mm² to 6 mm² 279 to 282 Series

0.08 - 1.5 mm ² 800 V/8 kV/3 ① I _N 18 A Terminal block width 4 mm / 0.157 in 8 - 9 mm / 0.33 in ②	AWG 28 - 16 600 V, 10 A ③ 600 V, 15 A ④	0.08 - 2.5 mm ² 800 V/8 kV/3 ① I _N 24 A Terminal block width 5 mm / 0.197 in 8 - 9 mm / 0.33 in ②	AWG 28 - 12 * 600 V, 20 A ③ 600 V, 20 A ④	0.08 - 4 mm ² 800 V/8 kV/3 ① I _N 32 A Terminal block width 6 mm / 0.236 in 9 - 10 mm / 0.37 in ②	AWG 28 - 12 600 V, 20 A ③ 600 V, 25 A ④
---	---	---	---	--	---

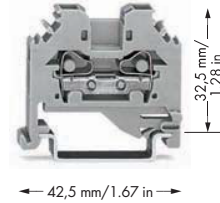
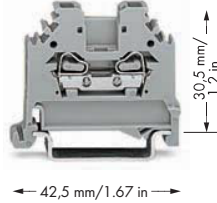
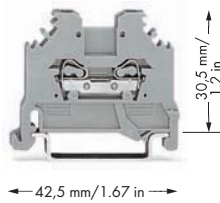

Item No.	Pack. Unit	Item No.	Pack. Unit	Item No.	Pack. Unit
2-conductor through terminal block		2-conductor through terminal block		2-conductor through terminal block	
gray	279-101 100	gray	280-101 100	gray	281-101 100
blue	279-104 ③ 100	blue	280-104 ③ 100	blue	281-104 ③ 100
2-conductor ground terminal block		2-conductor ground terminal block		2-conductor ground terminal block	
		green-yellow	280-107 100	green-yellow	281-107 100
Item-Specific Accessories		Item-Specific Accessories		Item-Specific Accessories	
End and intermediate plate, 2.5 mm thick		End and intermediate plate, 2.5 mm thick		End and intermediate plate, 3 mm thick	
orange	280-302 100 (4x25)	orange	280-302 100 (4x25)	orange	281-302 100 (4x25)
gray	280-301 100 (4x25)	gray	280-301 100 (4x25)	gray	281-301 100 (4x25)
Separator, oversized, 2 mm thick		Separator, oversized, 2 mm thick		Separator, oversized, 2 mm thick	
orange	280-322 100 (4x25)	orange	280-322 100 (4x25)	orange	281-322 100 (4x25)
gray	280-332 100 (4x25)	gray	280-332 100 (4x25)	gray	281-332 100 (4x25)
Adjacent jumper, insulated, I_N 15 A		Adjacent jumper, insulated, I_N = I_N terminal block		Adjacent jumper, insulated, I_N = I_N terminal block	
gray	279-402 200 (8x25)	gray	280-402 200 (8x25)	gray	281-402 200 (8x25)
yellow-green	279-422 200 (8x25)	yellow-green	280-422 200 (8x25)	yellow-green	281-422 200 (8x25)
Alternate jumper, insulated, I_N 15 A		Alternate jumper, insulated, I_N = I_N terminal block		Alternate jumper, insulated, I_N = I_N terminal block	
gray	279-409 100 (4x25)	gray	280-409 100 (4x25)	gray	281-409 100 (4x25)
Step-down jumper, insulated, I_N 15 A		Step-down jumper, insulated, I_N 15 A		Step-down jumper, insulated, I_N 15 A	
gray	284-414 50 (2x25)	gray	284-414 50 (2x25)	gray	284-414 50 (2x25)
Intermediate plate, 1 mm thick		Intermediate plate, 1 mm thick		Intermediate plate, 1 mm thick	
gray	281-333 100 (4x25)	gray	281-333 100 (4x25)	gray	281-333 100 (4x25)
orange	281-336 100 (4x25)	orange	281-336 100 (4x25)	orange	281-336 100 (4x25)
Protective warning marker, with high-voltage symbol, black, for 5 terminal blocks		Protective warning marker, with high-voltage symbol, black, for 5 terminal blocks		Step-down jumper, insulated, I_N 30 A	
yellow	279-405 100 (4x25)	yellow	280-405 100 (4x25)	gray	284-413 50 (2x25)
Test plug adapter, 8.3 mm wide, for terminal blocks 1.5 - 10 mm², for test plug 4 mm Ø		Test plug adapter, 8.3 mm wide, for terminal blocks 1.5 - 10 mm², for test plug 4 mm Ø		Step-down jumper, insulated, I_N 32 A	
gray	209-170 50 (2x25)	gray	209-170 50 (2x25)	gray	283-414 50 (2x25)
Test plug adapter, 5 mm wide, for terminal blocks 1.5 - 4 mm², for 210-137 test plug 2.3 mm Ø		Test plug adapter, 5 mm wide, for terminal blocks 1.5 - 4 mm², for 210-137 test plug 2.3 mm Ø		Protective warning marker, with high-voltage symbol, black, for 5 terminal blocks	
gray	280-404 100 (4x25)	gray	280-404 100 (4x25)	yellow	281-405 100 (4x25)
				Test plug adapter, 8.3 mm wide, for terminal blocks 1.5 - 10 mm², for test plug 4 mm Ø	
				gray	209-170 50 (2x25)

0.2 - 6 mm ²	AWG 24 - 10
800 V/8 kV/3 ①	600 V, 30 A TH
I _N 41 A	600 V, 10 A [@]
Terminal block width 8 mm / 0.315 in	
12 - 13 mm / 0.49 in ②	

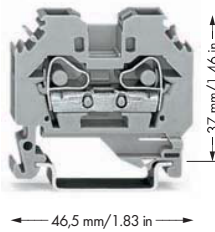

Carrier rail	Item No.	Curre [A]	Acc. to mm ² /AWG Cu
DIN 35 x 7.5 (steel)			
slotted	210-112	76	16/6
unslotted	210-113	76	16/6
DIN 35 x 15 (steel)			
1.5 mm thick	210-114	125	35/2
2.3 mm thick	210-118	125	35/2
DIN 35 x 7.5 (Al)			
unslotted	210-196	76	16/6
DIN 35 x 15 (Cu)			
2.3 mm thick	210-198	309	150/6/0

Current applies to rails of 1 m/3'3" length

If required to use standard carrier rails as ground conductor busbars, please refer to insert space between the **maximum current capacities** listed above. According to EN 60947-7-2 (VDE 0611, part 3), steel carrier rails shall not be used for PEN applications.

- * AWG 12: THHN, THWN
- 800 V = rated voltage
8 kV = rated surge voltage
3 = pollution degree
(also see Section 1.4)
 - Strip length, see packaging or instructions.
 - Suitable for Ex i applications
 - See application notes for:
Step-down jumper, page 309
Test plug module, page 197

	Item No.	Pack. Unit
2-conductor through terminal block		
○ gray	282-101	50
● blue	282-104 ③	50
2-conductor ground terminal block		
● green-yellow	282-107	50
Item-Specific Accessories		
End and intermediate plate, 4 mm thick		
	orange 282-302	100 (4x25)
	gray 282-301	100 (4x25)
Separator, oversized, 2 mm thick		
	orange 282-322	100 (4x25)
	gray 282-332	100 (4x25)
Adjacent jumper, insulated,		
	I _N 41 A	
	gray 282-402	100 (4x25)
	yellow-green 282-422	100 (4x25)
Alternate jumper, insulated,		
	I _N 41 A	
	gray 282-409	100 (4x25)
Step-down jumper, insulated,		
④	I _N 30 A	
	gray 284-413	50 (2x25)
Cover plate,		
	1 mm thick	
	gray 284-333	100 (4x25)
	orange 284-343	100 (4x25)
Protective warning marker,		
	with high-voltage symbol, black, for 5 terminal blocks	
	yellow 282-405	100 (4x25)
Test plug adapter, 8.3 mm wide,		
	for terminal blocks 1.5 - 10 mm ² , for test plug 4 mm Ø	
	gray 209-170	50 (2x25)
B-type test plug module,		
④	can be snapped together, 8 mm wide	
	gray 709-310	100 (4x25)
B-type spacer module,		
	can be snapped together, 8 mm wide	
	gray 709-311	100 (4x25)

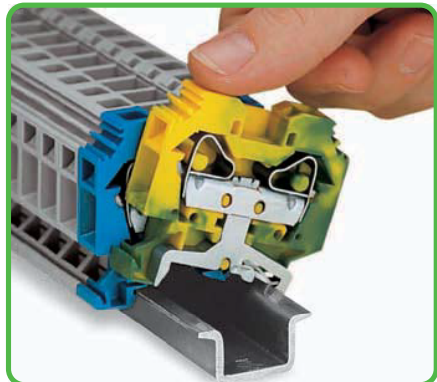

Snapping a terminal block onto the carrier rail.
Ground conductor terminal blocks snap onto the rail in the same way as through terminal blocks, but automatically make a direct electrical connection to the rail. Sliding on the rail is not then possible.

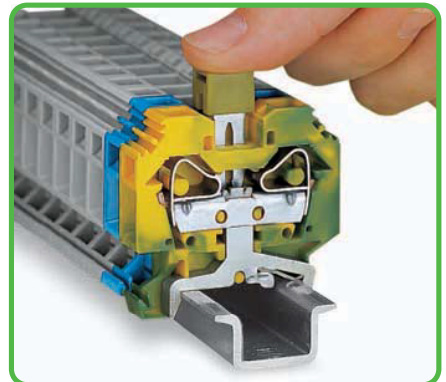

Push jumper down firmly until fully inserted.
Commoning ground conductor terminal blocks with through terminal blocks is possible in one direction only (via rear side of terminal block) using adjacent jumpers. In addition to the required marking of these blocks, use yellow-green adjacent jumpers.

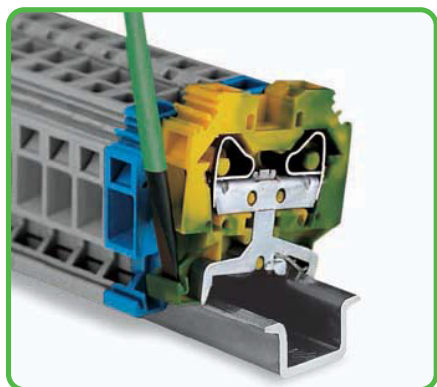

Removal from the carrier rail.
When mounting on the rail, ensure that open sides of terminal blocks face in the same direction. Both mounting feet and removal slots are on the same side for all terminal blocks, making it possible to visually ensure blocks are facing in same direction.