

Rail-Mounted Terminal Blocks 279 to 285 Series and 880 Series

Assembly



By snapping a ground conductor terminal block onto the carrier rail, a direct electrical connection is automatically made to the rail.

Assembly

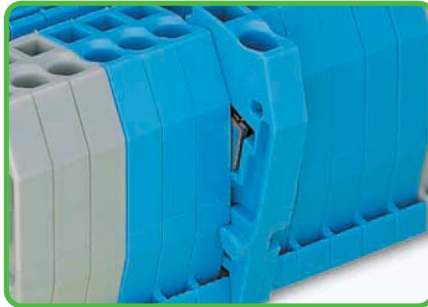

Quick assembly keys prevent reverse mounting.

Removal

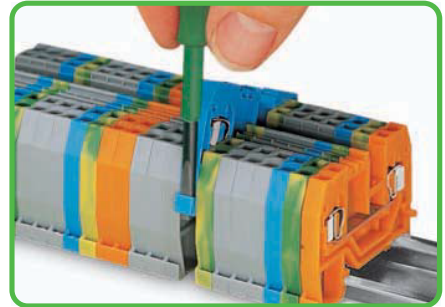

Removing a terminal block from the assembly.

Commoning

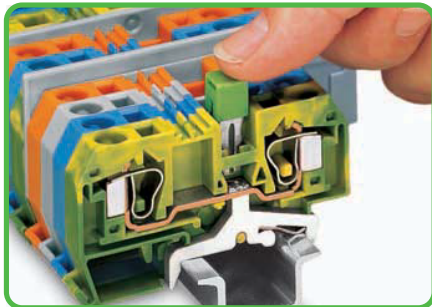

Commoning ground conductor terminal blocks with through terminal blocks is possible in one direction only (via rear side of terminal block) using adjacent jumpers. In addition to the required marking of these blocks, use yellow-green adjacent jumpers.

Commoning with step-down jumpers

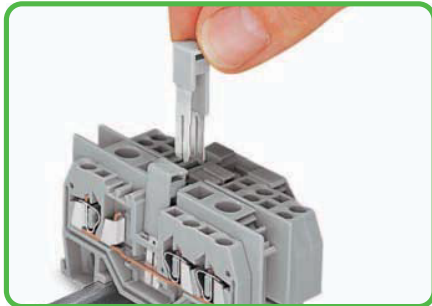

Commoning terminal blocks of different sizes – step down.
For application notes, see page 178.

Commoning

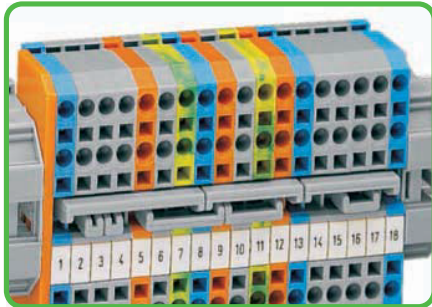

Staggered jumpers for sophisticated circuit requirements. Push jumpers down firmly until fully inserted. For additional notes, see page 201.

According to EN 60947-7-2 (VDE 0611, part 3), steel carrier rails shall not be used for PEN applications

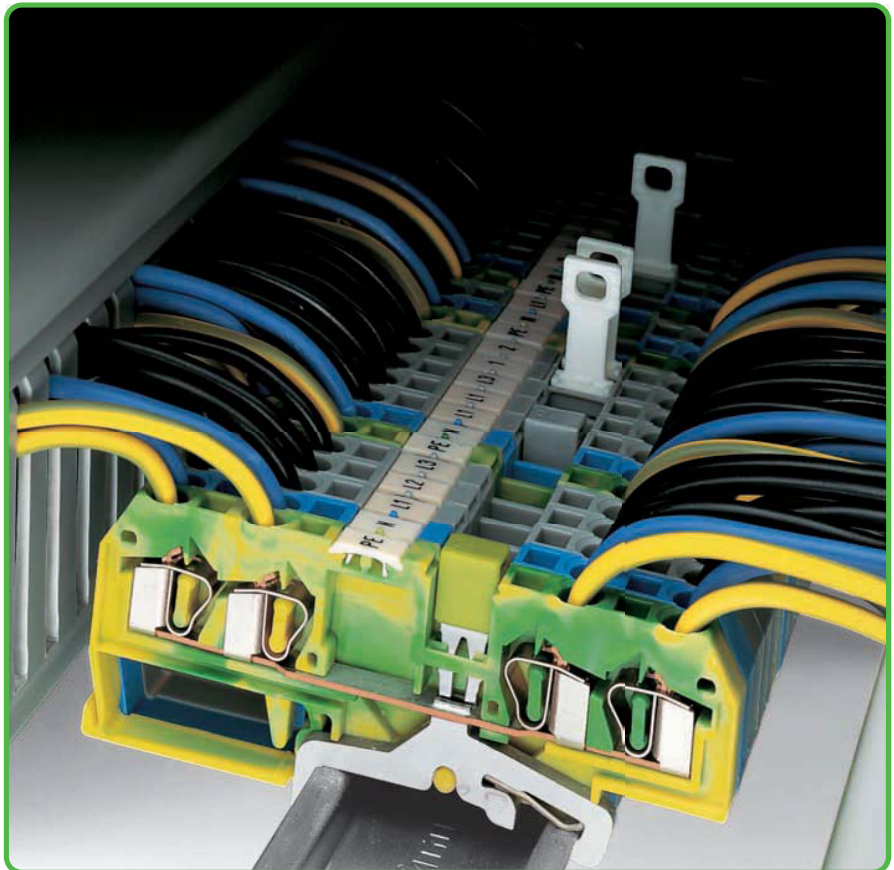

Testing - 880 Series

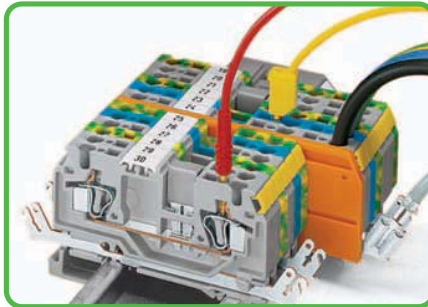

880 Series terminal blocks have an additional test slot for 2 mm Ø or 2.3 mm Ø test plugs.

Protective warning marker

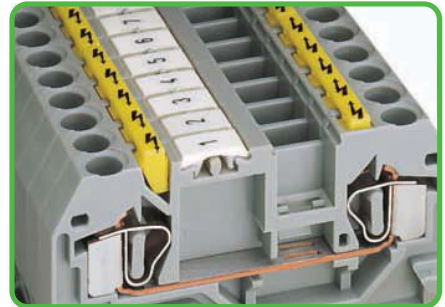

Protective warning markers inserted into the operating slots.

CAGE CLAMP®
clamps the following
copper conductors:*

solid

stranded

fine-stranded,
also with tinned
single strands

* For aluminum conductors, see notes in Section 14.

- Description and Handling -

CAGE CLAMP® connection

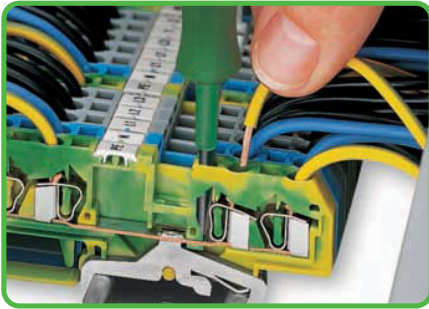

Conductor termination

CAGE CLAMP® connection

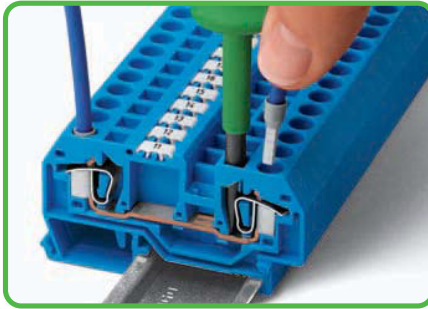

Conductor termination

❶ When using ferruled conductors, it is necessary to use a terminal block one size larger than the nominal cross section of the wire.

Testing

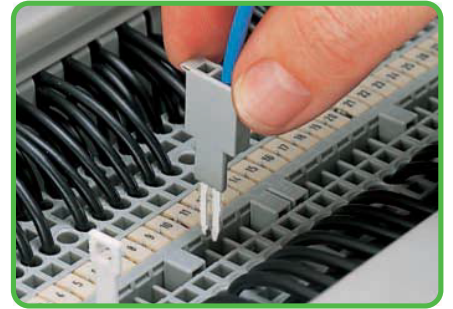

Testing with test plug.
Test plug fitted with CAGE CLAMP®.

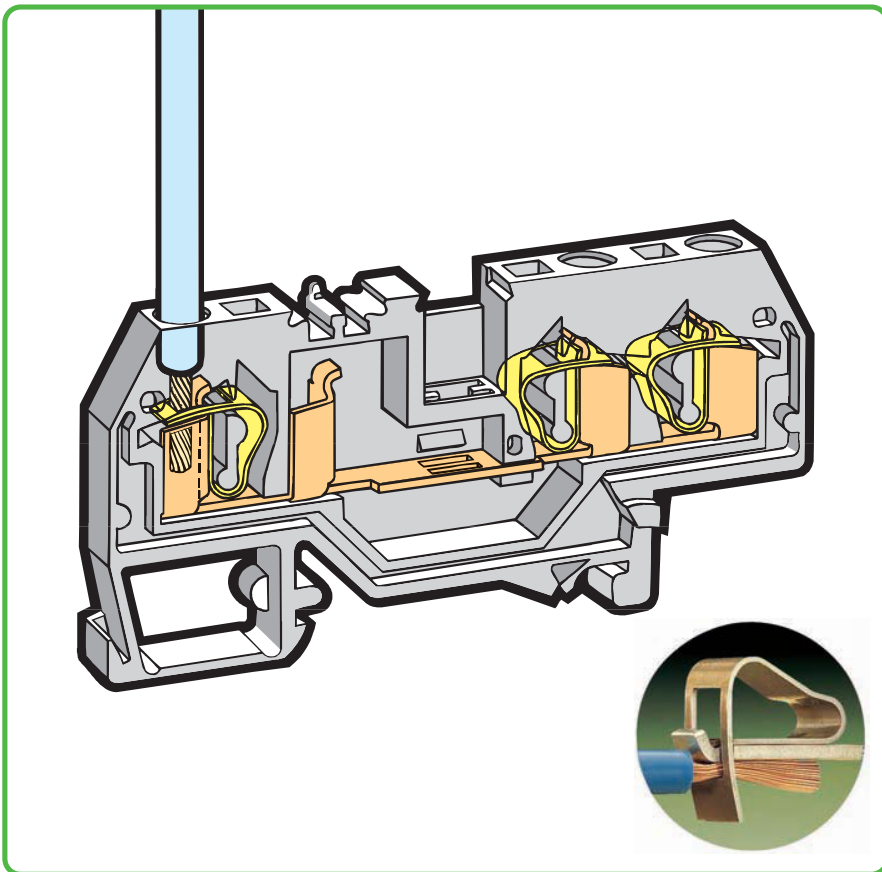

Testing

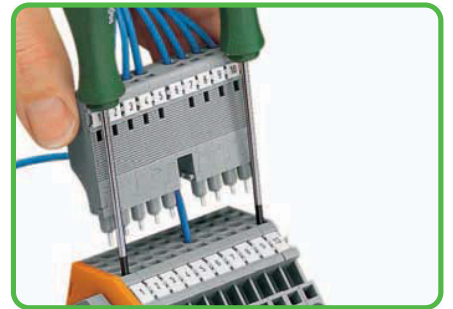

L-type test plug modules fitted with CAGE CLAMP®.
For application notes, see page 194.

Testing

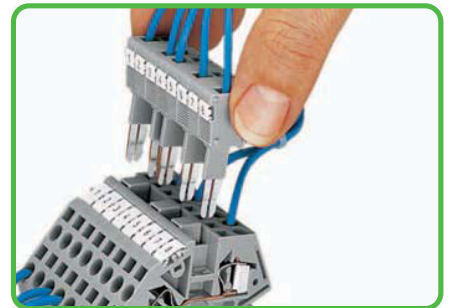

B-type test plug modules fitted with CAGE CLAMP®.
For application notes, see page 195.

Marking



Marking with WMB Multi marking system.
For additional systems, see Section 13.

Insulation stop

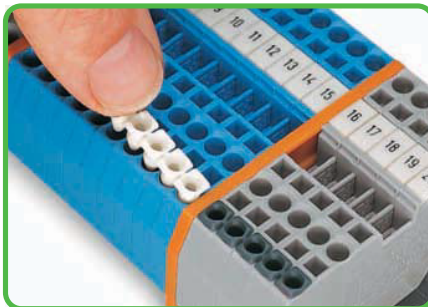

Insertion of insulation stop.
For application notes, see page 199.

Testing

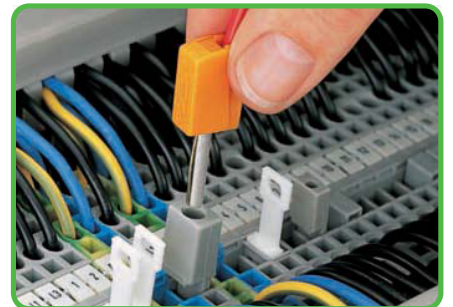

Testing with test plug.
Using 209-170 test plug adapter.

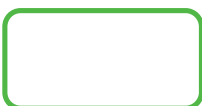

fine-stranded,
tip-bonded

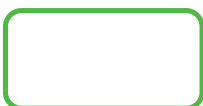

fine-stranded,
with ferrule ❶
(gastight crimped)

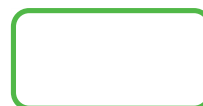

fine-stranded,
with pin terminal
(gastight crimped)

Through/Ground Conductor/Shield and Ex Terminal Blocks 2.5 mm² 280 Series

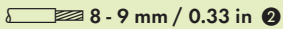
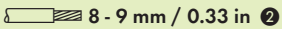
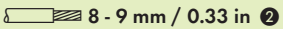
0.08 - 2.5 mm² 800 V/8 kV/3 ① I _N 24 A Terminal block width 5 mm / 0.197 in  8 - 9 mm / 0.33 in ②	AWG 28 - 12 * 600 V, 20 A ⑤ 600 V, 25 A ⑥	0.08 - 2.5 mm² 800 V/8 kV/3 ① I _N 24 A Terminal block width 5 mm / 0.197 in  8 - 9 mm / 0.33 in ②	AWG 28 - 12 * 600 V, 20 A ⑤ 600 V, 15 A ⑥	0.08 - 2.5 mm² 800 V/8 kV/3 ① I _N 20 A Terminal block width 5 mm / 0.197 in  8 - 9 mm / 0.33 in ②	AWG 28 - 12 * 600 V, 20 A ⑤ 600 V, 25 A ⑥
---	--	---	--	---	--

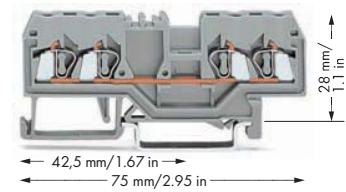
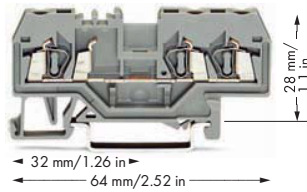
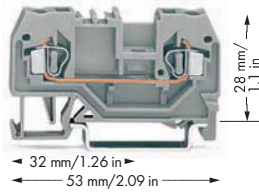

Item No.	Pack. Unit	Item No.	Pack. Unit	Item No.	Pack. Unit
2-conductor through terminal block		3-conductor through terminal block		4-conductor through terminal block	
gray 280-901	100	gray 280-681	100	gray 280-833	100
blue 280-904 ③	100	blue 280-684 ③	100	blue 280-834 ③	100
orange 280-902	100	orange 280-650	100	orange 280-835	100
red 280-903	100	red 280-653	100	red 280-830	100
black 280-905	100	black 280-671	100	black 280-831	100
yellow 280-906	100	yellow 280-672	100	yellow 280-832	100
light gray ⑤ 280-992 ④	100	light gray ⑤ 280-993 ④	100	light gray ⑤ 280-994 ④	100
2-conductor ground terminal block		3-conductor ground terminal block		4-conductor ground terminal block	
green-yellow 280-907	100	green-yellow 280-687	100	green-yellow 280-837	100
green-yellow ⑤ 280-907/999-950 ④	100	green-yellow ⑤ 280-687/999-950 ④	100	green-yellow ⑤ 280-837/999-950 ④	100
Other terminal blocks with the same profile:		Other terminal blocks with the same profile:		Other terminal blocks with the same profile:	
Diode 280-915/281-410	Page 256	Diode 280-673/281-410	Page 256	Diode 280-815/281-410	Page 256
Disconnect 280-912	Page 206	Disconnect 280-683	Page 206	LED 280-809/281-434	Page 256
Carrier 280-916	Page 232	Carrier 280-610	Page 232	Disconnect 280-836	Page 206
				Disc., test & meas. 280-829	Page 206
				Carrier 280-816	Page 232
				Double-potential 280-826	Page 163
Item-Specific Accessories		Item-Specific Accessories		Item-Specific Accessories	
End and intermediate plate, 2.5 mm thick		End and intermediate plate, 2.5 mm thick		End and intermediate plate, 2.5 mm thick	
orange 280-309	100 (4x25)	orange 280-326	100 (4x25)	orange 280-315	100 (4x25)
gray 280-308	100 (4x25)	gray 280-324	100 (4x25)	gray 280-314	100 (4x25)
light gray 280-356	100 (4x25)	light gray 280-358	100 (4x25)	light gray 280-352	100 (4x25)
Separator, oversized, 2 mm thick		Separator, oversized, 2 mm thick		Separator, oversized, 2 mm thick	
orange 280-311	100 (4x25)	orange 280-346	100 (4x25)	orange 280-335	100 (4x25)
gray 280-310	100 (4x25)	gray 280-344	100 (4x25)	gray 280-334	100 (4x25)
light gray 280-357	100 (4x25)	light gray 280-359	100 (4x25)	light gray 280-353	100 (4x25)
Ex e/Ex i separator, orange, 3 mm thick		Ex e/Ex i separator, orange, 3 mm thick		Ex e/Ex i separator, orange, 3 mm thick	
90 mm 209-190	50 (2x25)	120 mm 209-191	50 (2x25)	120 mm 209-191	50 (2x25)
120 mm 209-191	50 (2x25)				
Spacer of same shape, 5 mm thick		Spacer of same shape, 5 mm thick		Spacer of same shape, 5 mm thick	
orange 280-902/056-000	100 (4x25)	orange 280-650/056-000	100	orange 280-835/056-000	100 (4x25)
				Cover plate, 1 mm thick	
				gray 284-336	100
				orange 284-346	100

For list of approvals and user guide, see pages 634 to 637.