

Modular Terminal Blocks and Terminal Strips 260 to 262 Series

Assembly

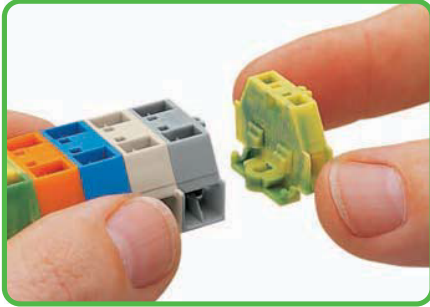

Assembling modular terminal blocks into terminal strips.

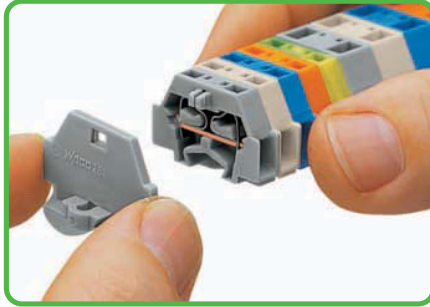

Mounting an end plate.

Fixing

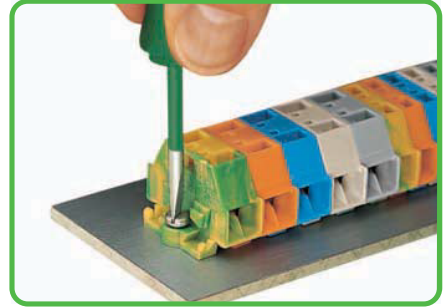

Terminal strip with fixing flanges, screw mount.

CAGE CLAMP® connection

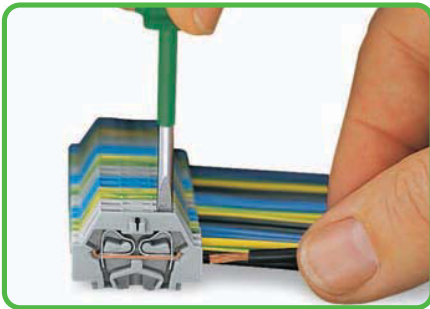

Conductor termination

CAGE CLAMP® connection

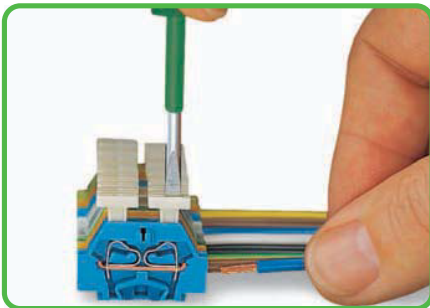

Conductor termination via push-button.

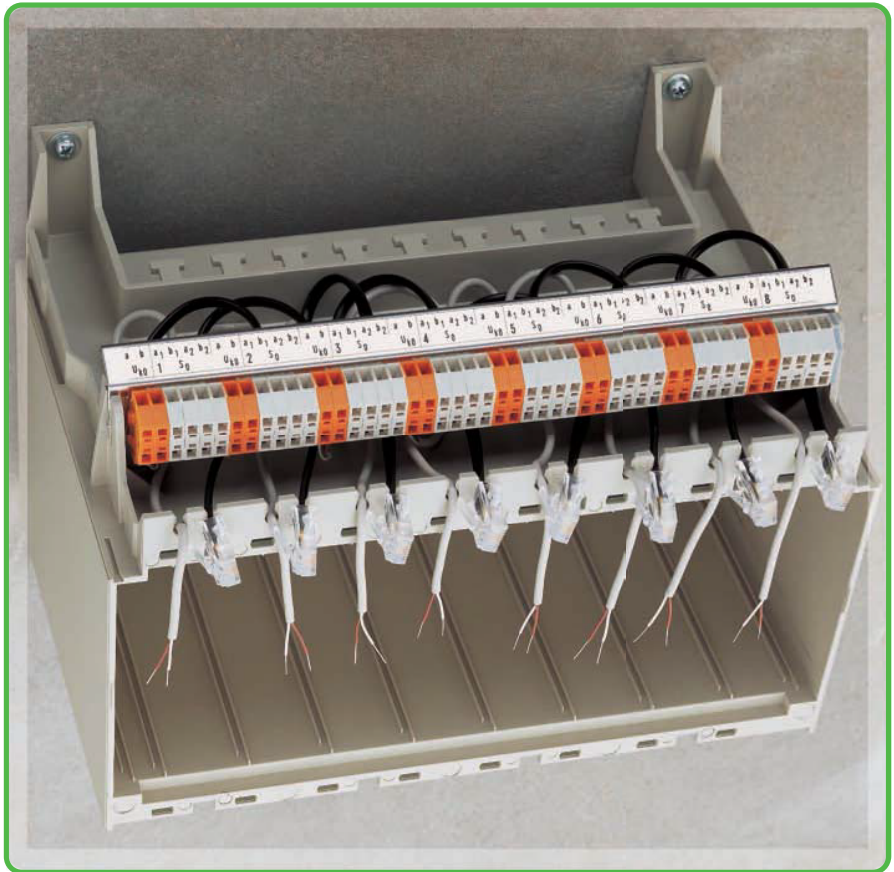

Types

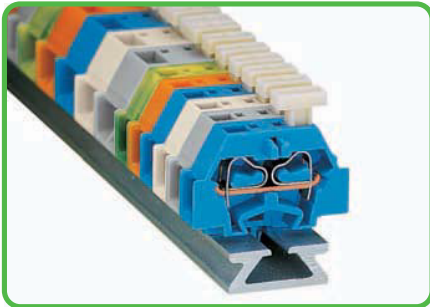

Terminal strip with push-buttons on one side.

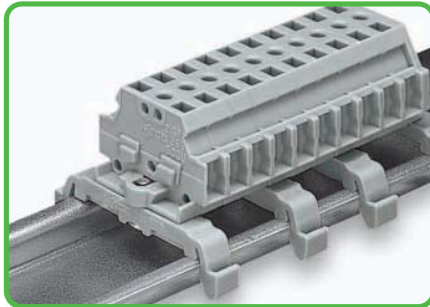

Terminal strip with marker slot for miniature WSB Quick marking system.

Commoning

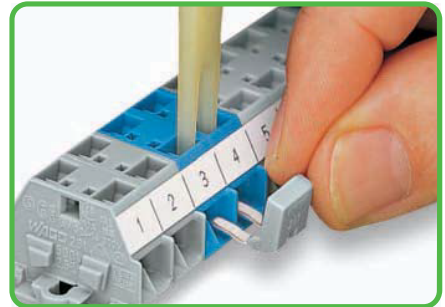

Commoning with comb-style jumper bar.

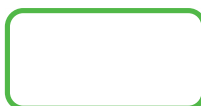

CAGE CLAMP®
clamps the following
copper conductors:*

solid

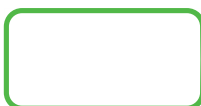

stranded

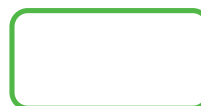

fine-stranded,
also with tinned
single strands

* For aluminum conductors, see notes in Section 14.

- Description and Handling -

Fixing



Terminal strip with snap-in mounting feet, mounting in holes.

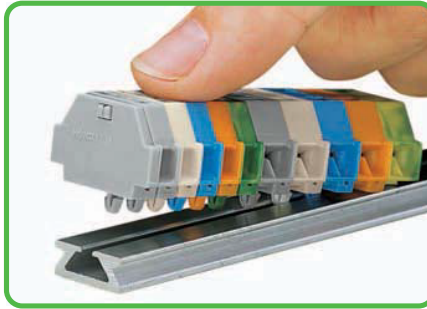

Terminal strip with snap-in mounting feet, mounting onto special aluminum rail.

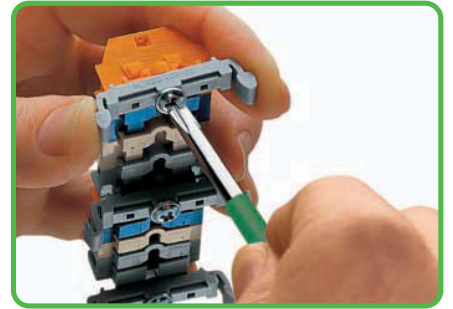

Terminal strip with fixing flanges, screw mounting of 209-123 mounting adapter
(The distance between mounting adapters should be 35 - 40 mm / 1.378 - 1.575 in max.).

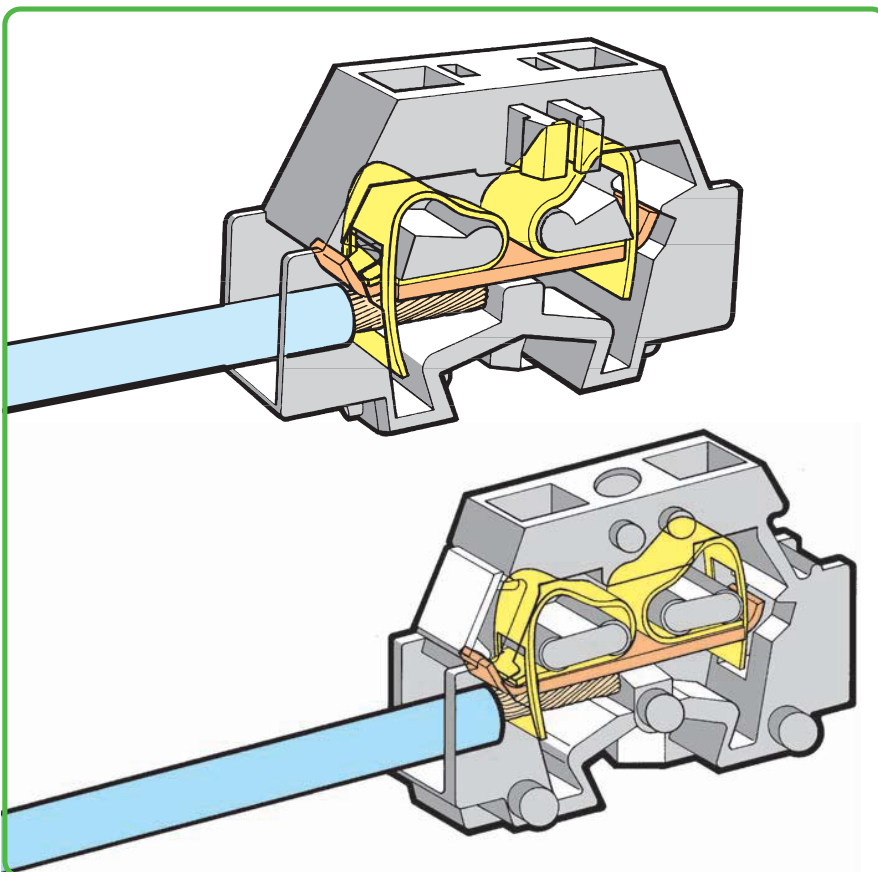

Fixing

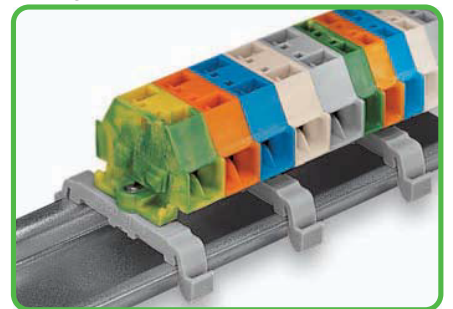

Terminal strip with fixing flanges, on DIN 35 rail.

Fixing

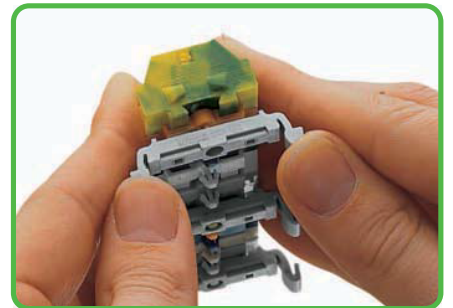

Terminal strip with snap-in mounting feet, connecting to 209-123 mounting adapter
(The distance between mounting adapters should be 35 - 40 mm / 1.378 - 1.575 in max.).

Marking



Marking with self-adhesive marker strips.

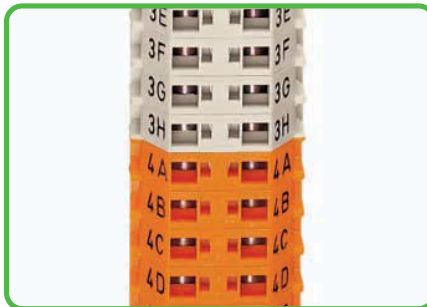

Marking by direct printing (on request).

Fixing

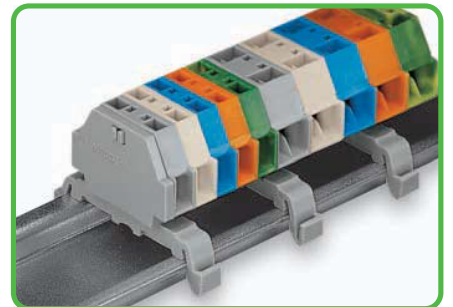

Terminal strip with snap-in mounting feet, on DIN 35 rail.

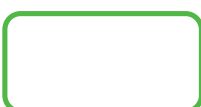

fine-stranded,
tip-bonded

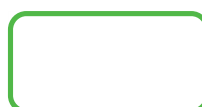

fine-stranded,
with ferrule ①
(gaslight crimped)

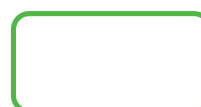



fine-stranded,
with pin terminal
(gaslight crimped)

① When using ferruled conductors, it is necessary to use a terminal block one size larger than the nominal cross section of the wire.

Modular Terminal Blocks with Fixing Flange or Snap-In Mounting Foot 2.5 mm²



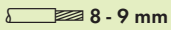













261 Series

CAGE CLAMP®

0.08 - 2.5 mm ² 500 V/6 kV/3 ① I _N 24 A	AWG 28 - 14 300 V, 15 A ② 300 V, 20 A ③	0.08 - 2.5 mm ² 500 V/6 kV/3 ① I _N 24 A	AWG 28 - 14 300 V, 15 A ② 300 V, 20 A ③
Terminal block width 6 mm / 0.236 in  8 - 9 mm / 0.33 in ②		Terminal block width 10 mm / 0.394 in  8 - 9 mm / 0.33 in ②	



- ① 500 V = rated voltage
6 kV = rated surge voltage
3 = pollution degree
(also see Section 14)
- ② Strip length, see packaging or instructions.
- ③ Suitable for Ex i applications
- ④ See application notes for:
Test plug module, page 456

Color	Item No.	Pack. Unit	Color	Item No.	Pack. Unit	261 Series Accessories
2-conductor terminal block with fixing flange, for screw or similar mounting types, fixing hole 3.2 mm Ø, with 209-123 mounting adapter also for DIN 35 rail			4-conductor terminal block with fixing flange, for screw or similar mounting types, fixing hole 3.2 mm Ø, with 209-123 mounting adapter also for DIN 35 rail			
gray	261-301	200 (4x50)	gray	261-331	200 (4x50)	Aluminum carrier rail,  1000 mm long, 18 mm wide, 7 mm high 210-154 1
light gray	261-303	200 (4x50)	light gray	261-333	200 (4x50)	
blue	261-304 ③	200 (4x50)	blue	261-334 ③	200 (4x50)	
orange	261-306	200 (4x50)	orange	261-336	200 (4x50)	
green-yellow	261-307	200 (4x50)	green-yellow	261-337	200 (4x50)	
2-conductor terminal block with snap-in mounting foot, for plate thickness 0.6-1.2 mm, fixing hole 3.5 mm Ø, fits 210-154 aluminum rail or with 209-120 mounting adapter for DIN 35 rail			4-conductor terminal block with snap-in mounting foot, for plate thickness 0.6-1.2 mm, fixing hole 3.5 mm Ø, fits 210-154 aluminum rail or with 209-120 mounting adapter for DIN 35 rail			End stop, for WSB Quick markers, for 210-154 aluminum rail, 6 mm wide  209-122 25
gray	261-311	200 (4x50)	gray	261-341	200 (4x50)	Mounting foot, for DIN 35 rail, can be snapped on terminal blocks with snap-in mounting foot, 6.4 mm wide  209-120 25
light gray	261-313	200 (4x50)	light gray	261-343	200 (4x50)	
blue	261-314 ③	200 (4x50)	blue	261-344 ③	200 (4x50)	Mounting foot with screw, for DIN 35 rail, can be screwed on terminal blocks with fixing flange, 6.4 mm wide  209-123 25
orange	261-316	200 (4x50)	orange	261-346	200 (4x50)	
green-yellow	261-317	200 (4x50)	green-yellow	261-347	200 (4x50)	Mounting adapter, for DIN 35 rail, can be used as end plate, 6.5 mm wide  209-137 25
2-conductor end terminal block, without fixing foot, for terminal strips with snap-in mounting feet			4-conductor end terminal block, without fixing foot, for terminal strips with snap-in mounting feet			Test plug,  with 500 mm cable, 2 mm Ø, red 210-136 50
gray	261-321	200 (4x50)	gray	261-351	200 (4x50)	Test plug,  with 500 mm cable, 2.3 mm Ø, yellow 210-137 50
light gray	261-323	200 (4x50)	light gray	261-353	200 (4x50)	
blue	261-324 ③	200 (4x50)	blue	261-354 ③	200 (4x50)	Operating tool with partially insulated shaft,  type 2, (3.5 x 0.5) mm blade 210-720 1
orange	261-326	200 (4x50)	orange	261-356	200 (4x50)	
green-yellow	261-327	200 (4x50)	green-yellow	261-357	200 (4x50)	
Item-Specific Accessories			Item-Specific Accessories			
Test plug module,  ④ can be snapped together, 6 mm wide gray 249-136 100 (4x25)			Test plug module,  ④ can be snapped together, 10 mm wide gray 249-139 100 (4x25)			
Test plug module with locking levers,  ④ can be snapped together, 6 mm wide gray 261-404 100 (4x25)			Test plug module with locking levers,  ④ can be snapped together, 10 mm wide gray 261-405 100 (4x25)			
261 Series Accessories						
For marking accessories, see Section 13						
End plate with fixing flange  gray 261-361 300 (6x50)			Comb-style jumper bar, insulated, I _N 16 A, gray, reduces maximum conductor size to 1.5 mm ² /AWG 16  2-way 261-402 25			
End plate with snap-in mounting foot  gray 261-371 300 (6x50)			Operating tool, of insulating material, for inserting comb-style jumper bars  2-way 209-132 1			