

# Modular Terminal Blocks and Terminal Strips 260 to 262 Series

## Assembly

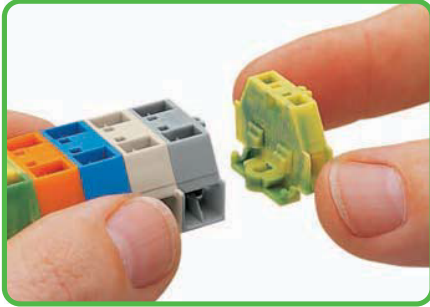

Assembling modular terminal blocks into terminal strips.

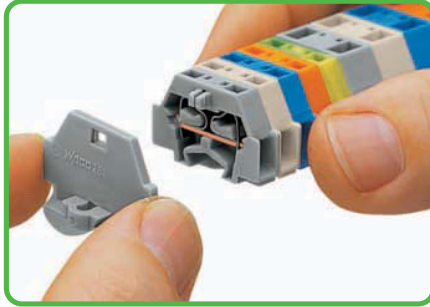

Mounting an end plate.

## Fixing

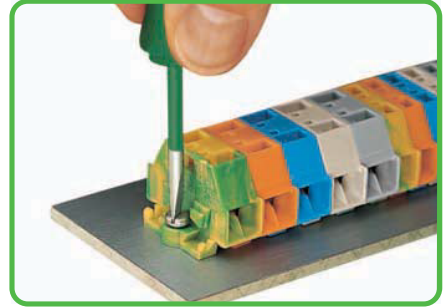

Terminal strip with fixing flanges, screw mount.

## CAGE CLAMP® connection

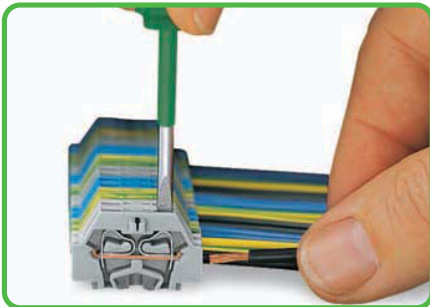

Conductor termination

## CAGE CLAMP® connection

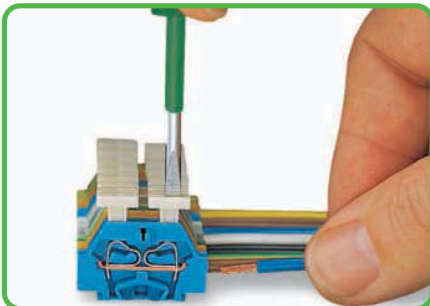

Conductor termination via push-button.

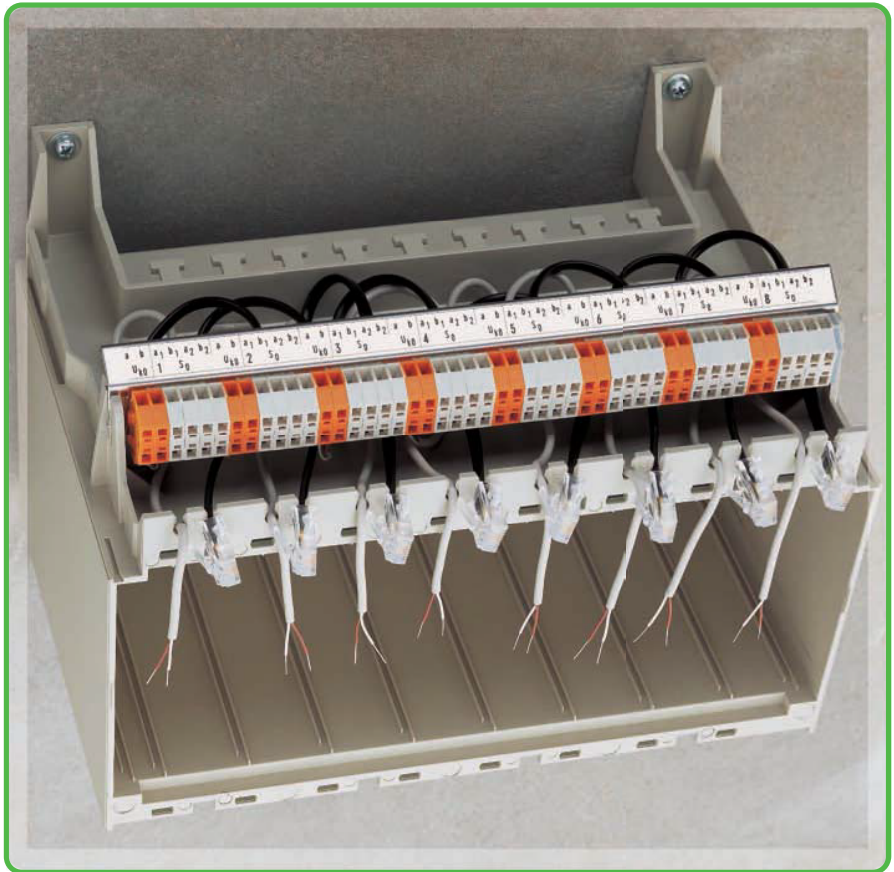

## Types

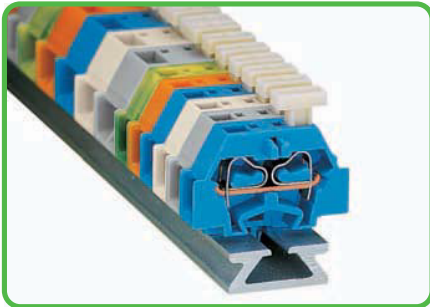

Terminal strip with push-buttons on one side.

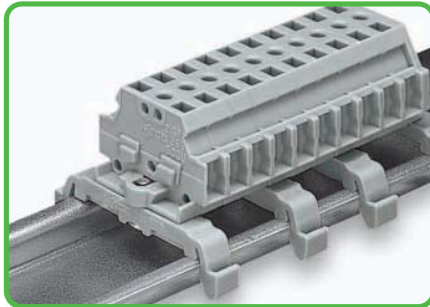

Terminal strip with marker slot for miniature WSB Quick marking system.

## Commoning

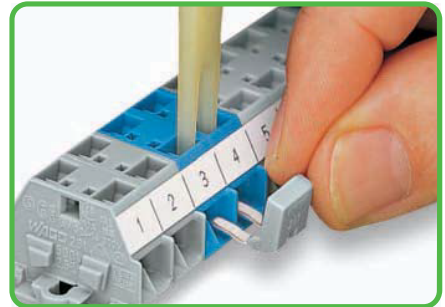

Commoning with comb-style jumper bar.

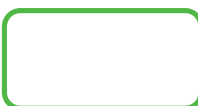

**CAGE CLAMP®**  
clamps the following  
copper conductors:\*

solid

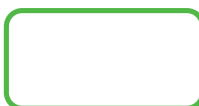

stranded

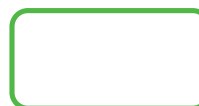

fine-stranded,  
also with tinned  
single strands

\* For aluminum conductors, see notes in Section 14.

## - Description and Handling -

### Fixing



Terminal strip with snap-in mounting feet, mounting in holes.

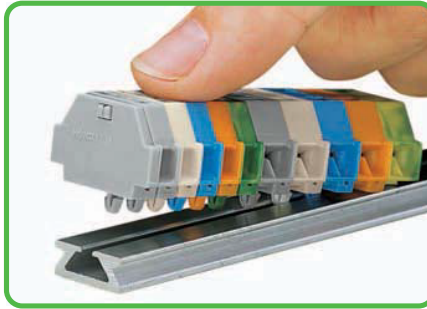

Terminal strip with snap-in mounting feet, mounting onto special aluminum rail.

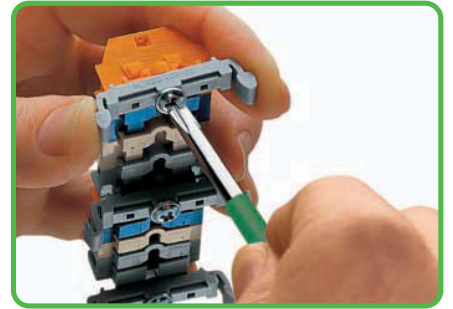

Terminal strip with fixing flanges, screw mounting of 209-123 mounting adapter (The distance between mounting adapters should be 35 - 40 mm / 1.378 - 1.575 in max.).

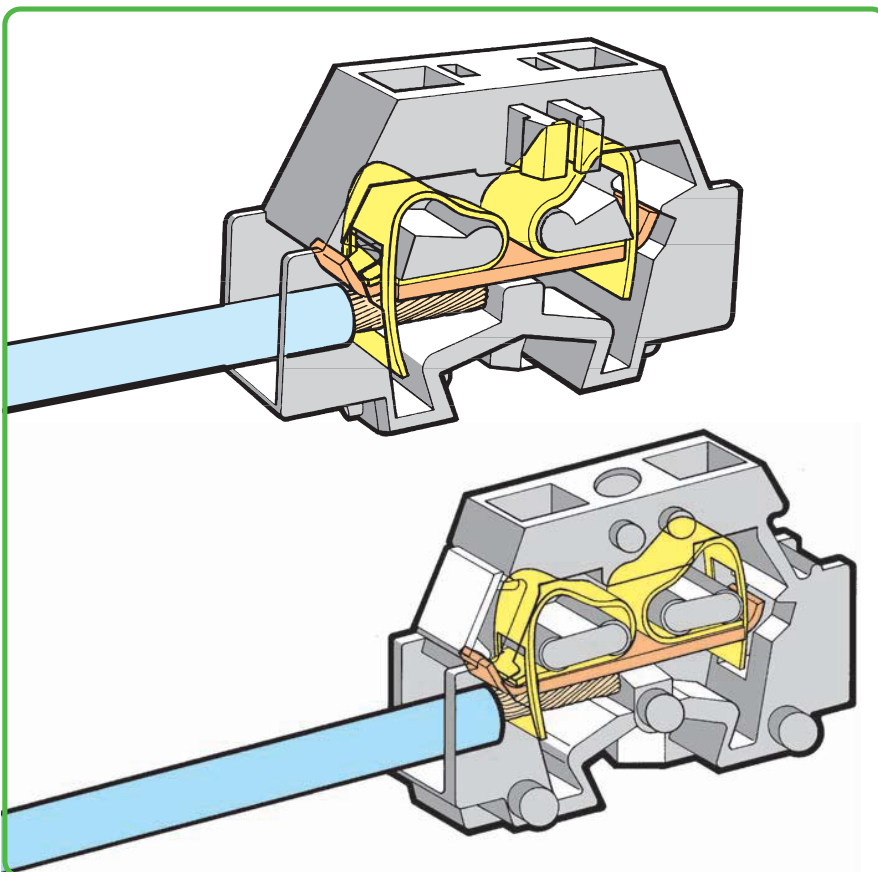

### Fixing

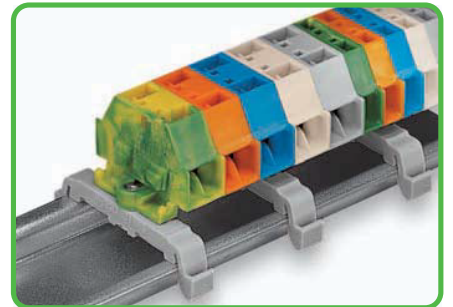

Terminal strip with fixing flanges, on DIN 35 rail.

### Fixing

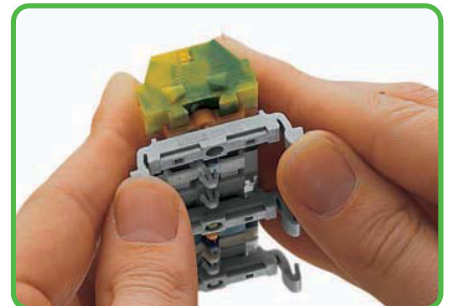

Terminal strip with snap-in mounting feet, connecting to 209-123 mounting adapter (The distance between mounting adapters should be 35 - 40 mm / 1.378 - 1.575 in max.).

### Marking



Marking with self-adhesive marker strips.

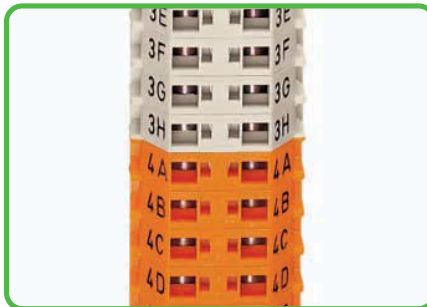

Marking by direct printing (on request).

### Fixing

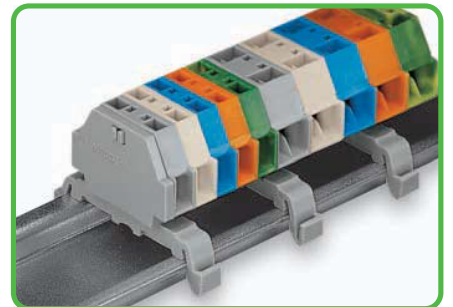

Terminal strip with snap-in mounting feet, on DIN 35 rail.

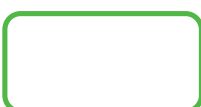

fine-stranded, tip-bonded

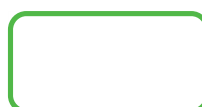

fine-stranded, with ferrule ① (gaslight crimped)

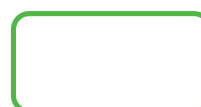



fine-stranded, with pin terminal (gaslight crimped)

① When using ferruled conductors, it is necessary to use a terminal block one size larger than the nominal cross section of the wire.



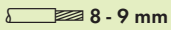











# Modular Terminal Blocks with Fixing Flange or Snap-In Mounting Foot 2.5 mm<sup>2</sup> 261 Series

CAGE CLAMP®

0.08 - 2.5 mm <sup>2</sup> 500 V/6 kV/3 ① I <sub>N</sub> 24 A	AWG 28 - 14 300 V, 15 A ④ 300 V, 20 A ④	0.08 - 2.5 mm <sup>2</sup> 500 V/6 kV/3 ① I <sub>N</sub> 24 A	AWG 28 - 14 300 V, 15 A ④ 300 V, 20 A ④
Terminal block width 6 mm / 0.236 in  8 - 9 mm / 0.33 in ②		Terminal block width 10 mm / 0.394 in  8 - 9 mm / 0.33 in ②	



- ① 500 V = rated voltage  
6 kV = rated surge voltage  
3 = pollution degree  
(also see Section 14)
- ② Strip length, see packaging or instructions.
- ③ Suitable for Ex i applications
- ④ See application notes for:  
Test plug module, page 456

Color	Item No.	Pack. Unit	Color	Item No.	Pack. Unit	261 Series Accessories
2-conductor terminal block with fixing flange, for screw or similar mounting types, fixing hole 3.2 mm Ø, with 209-123 mounting adapter also for DIN 35 rail			4-conductor terminal block with fixing flange, for screw or similar mounting types, fixing hole 3.2 mm Ø, with 209-123 mounting adapter also for DIN 35 rail			
gray	261-301	200 (4x50)	gray	261-331	200 (4x50)	
light gray	261-303	200 (4x50)	light gray	261-333	200 (4x50)	<b>Aluminum carrier rail,</b>  1000 mm long, 18 mm wide, 7 mm high <b>210-154</b> 1
blue	261-304 ③	200 (4x50)	blue	261-334 ③	200 (4x50)	<b>End stop, for WSB Quick markers,</b>  for 210-154 aluminum rail, 6 mm wide <b>209-122</b> 25
orange	261-306	200 (4x50)	orange	261-336	200 (4x50)	<b>Mounting foot, for DIN 35 rail, can be snapped on</b>  terminal blocks with snap-in mounting foot, 6.4 mm wide gray <b>209-120</b> 25
green-yellow	261-307	200 (4x50)	green-yellow	261-337	200 (4x50)	<b>Mounting foot with screw, for DIN 35 rail, can be</b>  screwed on terminal blocks with fixing flange, 6.4 mm wide gray <b>209-123</b> 25
2-conductor terminal block with snap-in mounting foot, for plate thickness 0.6-1.2 mm, fixing hole 3.5 mm Ø, fits 210-154 aluminum rail or with 209-120 mounting adapter for DIN 35 rail			4-conductor terminal block with snap-in mounting foot, for plate thickness 0.6-1.2 mm, fixing hole 3.5 mm Ø, fits 210-154 aluminum rail or with 209-120 mounting adapter for DIN 35 rail			<b>Mounting adapter, for DIN 35 rail,</b>  can be used as end plate, 6.5 mm wide gray <b>209-137</b> 25
gray	261-311	200 (4x50)	gray	261-341	200 (4x50)	<b>Test plug,</b>  with 500 mm cable, 2 mm Ø, red <b>210-136</b> 50
light gray	261-313	200 (4x50)	light gray	261-343	200 (4x50)	<b>Test plug,</b>  with 500 mm cable, 2.3 mm Ø, yellow <b>210-137</b> 50
blue	261-314 ③	200 (4x50)	blue	261-344 ③	200 (4x50)	<b>Operating tool with partially insulated shaft,</b>  type 2, (3.5 x 0.5) mm blade <b>210-720</b> 1
orange	261-316	200 (4x50)	orange	261-346	200 (4x50)	
green-yellow	261-317	200 (4x50)	green-yellow	261-347	200 (4x50)	
2-conductor end terminal block, without fixing foot, for terminal strips with snap-in mounting feet			4-conductor end terminal block, without fixing foot, for terminal strips with snap-in mounting feet			
gray	261-321	200 (4x50)	gray	261-351	200 (4x50)	
light gray	261-323	200 (4x50)	light gray	261-353	200 (4x50)	
blue	261-324 ③	200 (4x50)	blue	261-354 ③	200 (4x50)	
orange	261-326	200 (4x50)	orange	261-356	200 (4x50)	
green-yellow	261-327	200 (4x50)	green-yellow	261-357	200 (4x50)	
<b>Item-Specific Accessories</b>			<b>Item-Specific Accessories</b>			
④  Test plug module, can be snapped together, 6 mm wide gray <b>249-136</b> 100 (4x25)			④  Test plug module, can be snapped together, 10 mm wide gray <b>249-139</b> 100 (4x25)			
④  Test plug module with locking levers, can be snapped together, 6 mm wide gray <b>261-404</b> 100 (4x25)			④  Test plug module with locking levers, can be snapped together, 10 mm wide gray <b>261-405</b> 100 (4x25)			
<b>261 Series Accessories</b>						
For marking accessories, see Section 13						
<b>End plate with fixing flange</b>  gray <b>261-361</b> 300 (6x50)			<b>Comb-style jumper bar, insulated, I<sub>N</sub> 16 A, gray,</b> reduces maximum conductor size to 1.5 mm <sup>2</sup> /AWG 16 2-way <b>261-402</b> 25			
<b>End plate with snap-in mounting foot</b>  gray <b>261-371</b> 300 (6x50)			<b>Operating tool, of insulating material,</b> for inserting comb-style jumper bars 2-way <b>209-132</b> 1			