

Modular Terminal Blocks and Terminal Strips 260 to 262 Series

Assembly

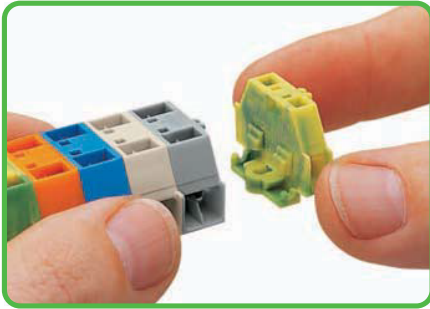

Assembling modular terminal blocks into terminal strips.



Mounting an end plate.

Fixing

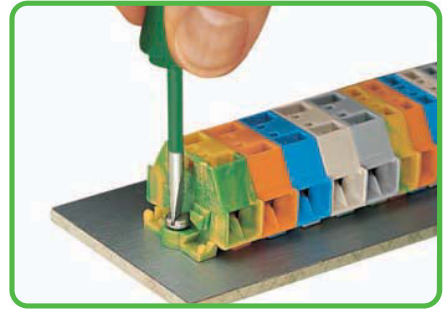

Terminal strip with fixing flanges, screw mount.

CAGE CLAMP® connection

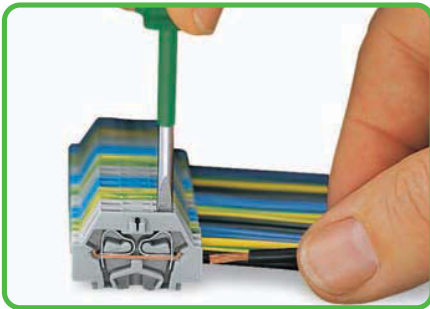

Conductor termination

CAGE CLAMP® connection

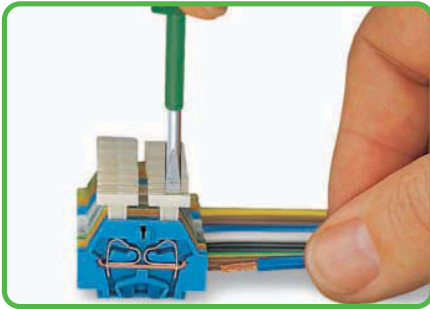

Conductor termination via push-button.

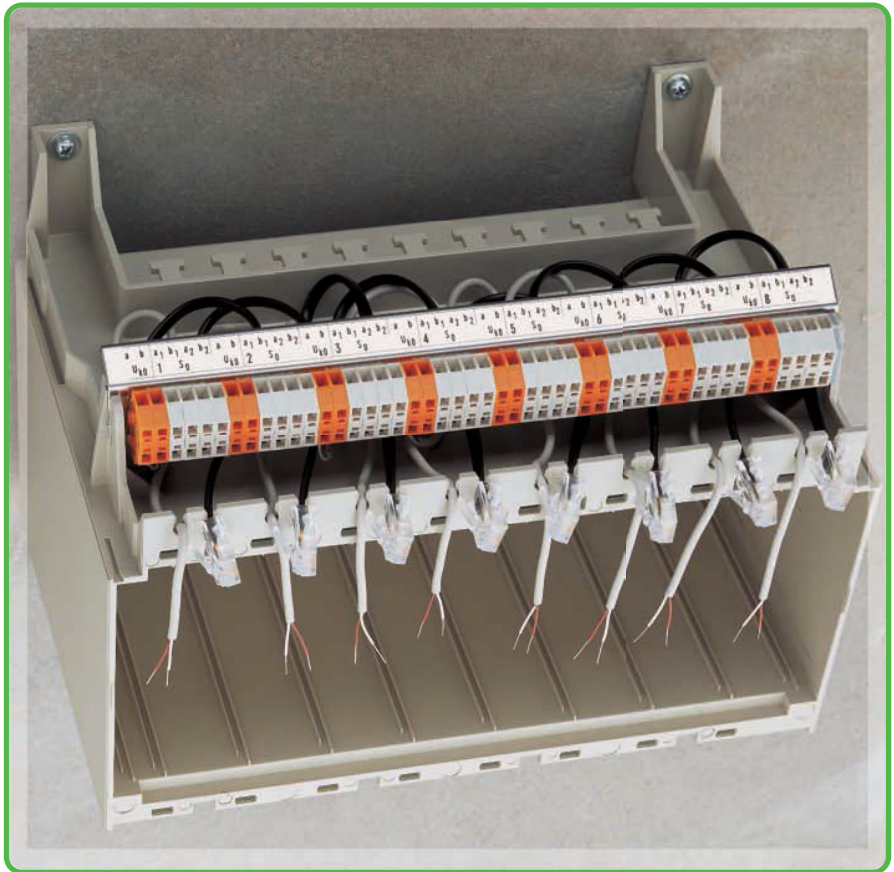

Types

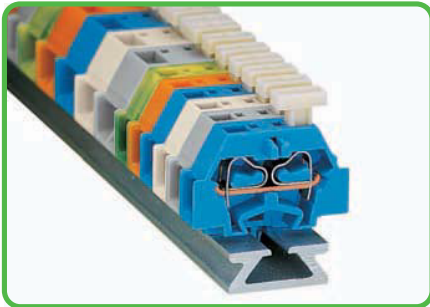

Terminal strip with push-buttons on one side.

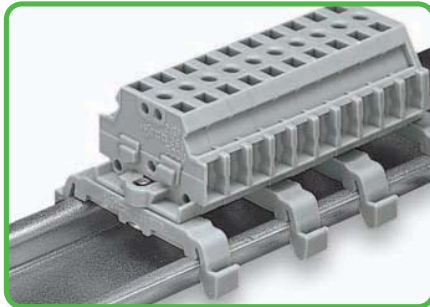

Terminal strip with marker slot for miniature WSB Quick marking system.

Commoning

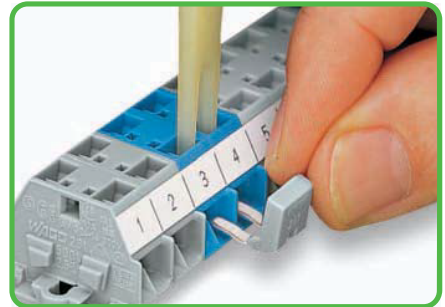

Commoning with comb-style jumper bar.

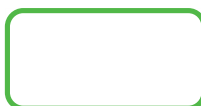

CAGE CLAMP®
clamps the following
copper conductors:*

solid

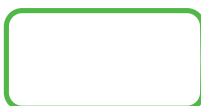

stranded

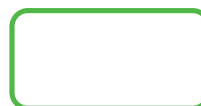

fine-stranded,
also with tinned
single strands

* For aluminum conductors, see notes in Section 14.

- Description and Handling -

Fixing



Terminal strip with snap-in mounting feet, mounting in holes.

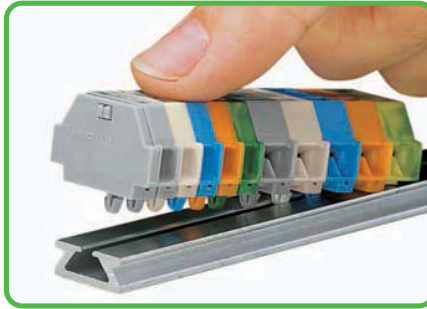

Terminal strip with snap-in mounting feet, mounting onto special aluminum rail.

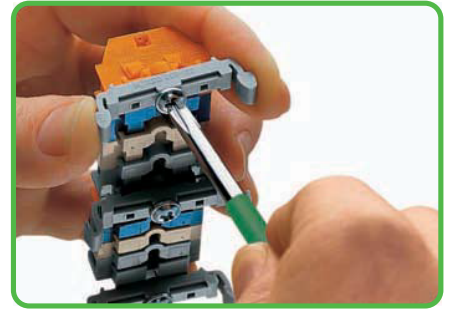

Terminal strip with fixing flanges, screw mounting of 209-123 mounting adapter (The distance between mounting adapters should be 35 - 40 mm / 1.378 - 1.575 in max.).

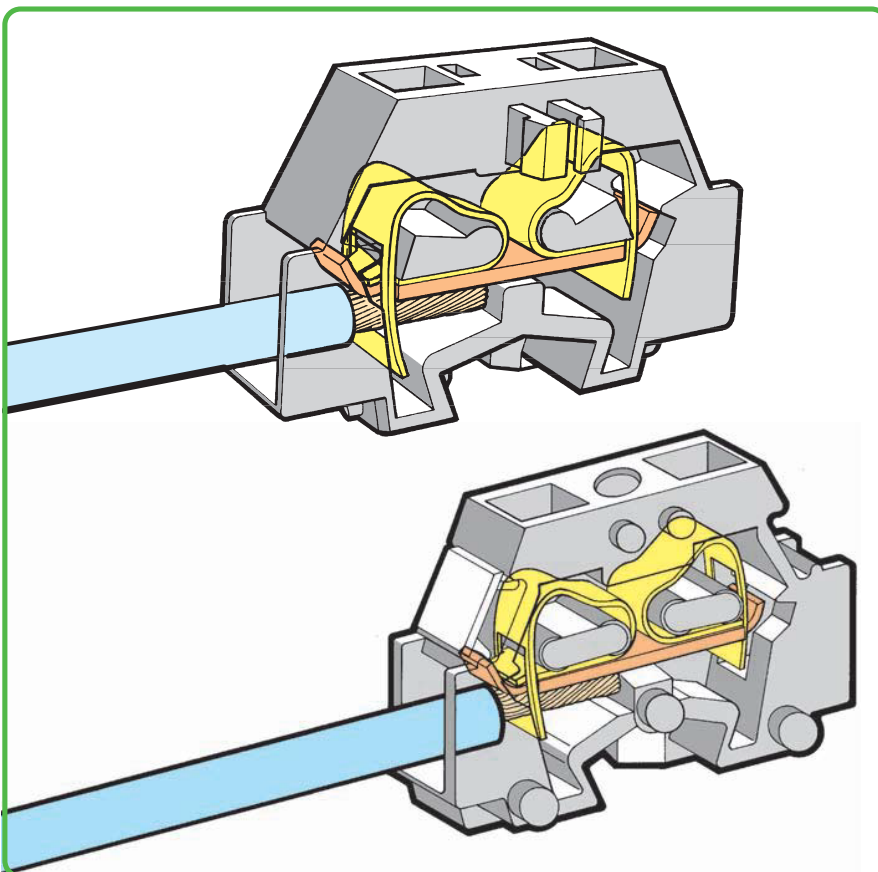

Fixing

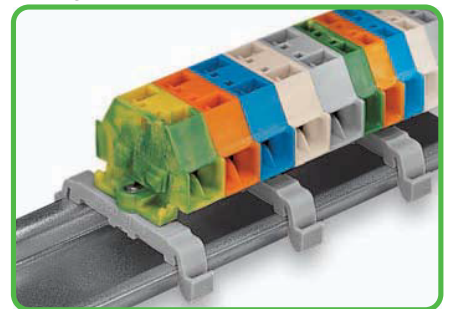

Terminal strip with fixing flanges, on DIN 35 rail.

Fixing

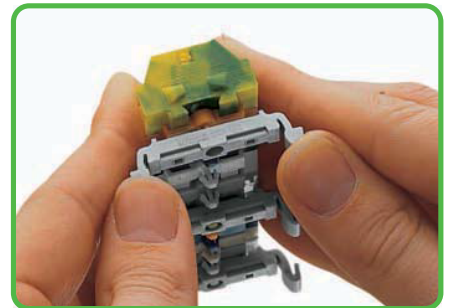

Terminal strip with snap-in mounting feet, connecting to 209-123 mounting adapter (The distance between mounting adapters should be 35 - 40 mm / 1.378 - 1.575 in max.).

Marking



Marking with self-adhesive marker strips.

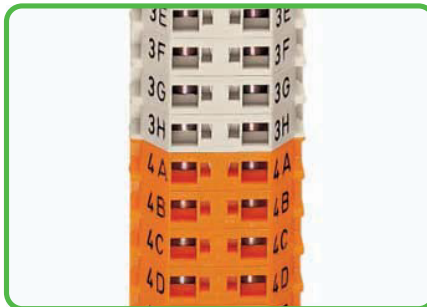

Marking by direct printing (on request).

Fixing

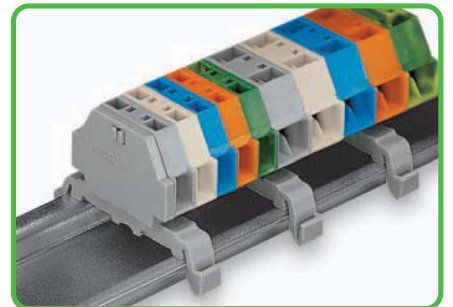

Terminal strip with snap-in mounting feet, on DIN 35 rail.

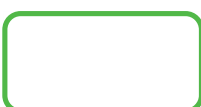

fine-stranded, tip-bonded

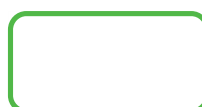

fine-stranded, with ferrule ¹ (gaslight crimped)

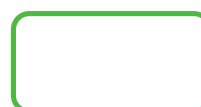

fine-stranded, with pin terminal (gaslight crimped)

¹ When using ferruled conductors, it is necessary to use a terminal block one size larger than the nominal cross section of the wire.

Modular Terminal Blocks with Fixing Flange or Snap-In Mounting Foot 1.5 mm²





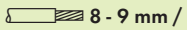
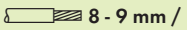











260 Series

CAGE CLAMP®

0.08 - 1.5 mm ² 400 V/6 kV/3 ① I _N 18 A	AWG 28 - 16 300 V, 10 A ② 300 V, 15 A ③	0.08 - 1.5 mm ² 400 V/6 kV/3 ① I _N 18 A	AWG 28 - 16 300 V, 10 A ② 300 V, 15 A ③
Terminal block width 5 mm / 0.197 in  8 - 9 mm / 0.33 in ②		Terminal block width 8 mm / 0.315 in  8 - 9 mm / 0.33 in ②	



- ① 400 V = rated voltage
6 kV = rated surge voltage
3 = pollution degree
(also see Section 14)
- ② Strip length, see packaging or instructions.
- ③ See application notes for:
Test plug module, page 456

Color	Item No.	Pack. Unit	Color	Item No.	Pack. Unit	260 Series Accessories
2-conductor terminal block with fixing flange, for screw or similar mounting types, fixing hole 3.2 mm Ø, with 209-123 mounting adapter also for DIN 35 rail			4-conductor terminal block with fixing flange, for screw or similar mounting types, fixing hole 3.2 mm Ø, with 209-123 mounting adapter also for DIN 35 rail			
gray	260-301	300 (6x50)	gray	260-331	300 (6x50)	
light gray	260-303	300 (6x50)	light gray	260-333	300 (6x50)	Aluminum carrier rail,  1000 mm long, 18 mm wide, 7 mm high 210-154 1
blue	260-304	300 (6x50)	blue	260-334	300 (6x50)	End stop, for WSB Quick markers, for 210-154 aluminum rail, 6 mm wide  209-122 25
orange	260-306	300 (6x50)	orange	260-336	300 (6x50)	Mounting foot, for DIN 35 rail, can be snapped on terminal blocks with snap-in mounting foot, 6.4 mm wide  209-120 25
green-yellow	260-307	300 (6x50)	green-yellow	260-337	300 (6x50)	Mounting foot with screw, for DIN 35 rail, can be screwed on terminal blocks with fixing flange, 6.4 mm wide  209-123 25
2-conductor terminal block with snap-in mounting foot, for plate thickness 0.6-1.2 mm, fixing hole 3.5 mm Ø, fits 210-154 aluminum rail or with 209-120 mounting adapter for DIN 35 rail			4-conductor terminal block with snap-in mounting foot, for plate thickness 0.6-1.2 mm, fixing hole 3.5 mm Ø, fits 210-154 aluminum rail or with 209-120 mounting adapter for DIN 35 rail			Mounting adapter, for DIN 35 rail, can be used as end plate, 6.5 mm wide  gray 209-137 25
gray	260-311	300 (6x50)	gray	260-341	300 (6x50)	Test plug,  with 500 mm cable, 2 mm Ø, red 210-136 50
light gray	260-313	300 (6x50)	light gray	260-343	300 (6x50)	Test plug,  with 500 mm cable, 2.3 mm Ø, yellow 210-137 50
blue	260-314	300 (6x50)	blue	260-344	300 (6x50)	Operating tool with partially insulated shaft,  type 2, (3.5 x 0.5) mm blade 210-720 1
orange	260-316	300 (6x50)	orange	260-346	300 (6x50)	
green-yellow	260-317	300 (6x50)	green-yellow	260-347	300 (6x50)	
2-conductor end terminal block, without fixing foot, for terminal strips with snap-in mounting feet			4-conductor end terminal block, without fixing foot, for terminal strips with snap-in mounting feet			
gray	260-321	300 (6x50)	gray	260-351	300 (6x50)	
light gray	260-323	300 (6x50)	light gray	260-353	300 (6x50)	
blue	260-324	300 (6x50)	blue	260-354	300 (6x50)	
orange	260-326	300 (6x50)	orange	260-356	300 (6x50)	
green-yellow	260-327	300 (6x50)	green-yellow	260-357	300 (6x50)	
Item-Specific Accessories			Item-Specific Accessories			
Test plug module, ③  can be snapped together, 5 mm wide gray 249-135 100 (4x25)			Test plug module, ③  can be snapped together, 8 mm wide gray 249-138 100 (4x25)			
Test plug module with locking levers, ③  can be snapped together, 5 mm wide gray 260-404 100 (4x25)			Test plug module with locking levers, ③  can be snapped together, 8 mm wide gray 260-405 100 (4x25)			
260 Series Accessories						
For marking accessories, see Section 13						
End plate with fixing flange  gray 260-361 300 (6x50)			Comb-style jumper bar, insulated, I _N 10 A, gray, reduces maximum conductor size to 1 mm ² /AWG 16  2-way 260-402 25			
End plate with snap-in mounting foot  gray 260-371 300 (6x50)			Operating tool, of insulating material, for inserting comb-style jumper bars  2-way 209-132 1			