

1 CAGE CLAMP® S Rail-Mounted Terminal Blocks 2000 to 2016 Series

50

Simply push-in



Directly insert solid and ferruled conductors.

Conductor termination



Terminating fine-stranded conductors using an operating tool.

Insulation stop

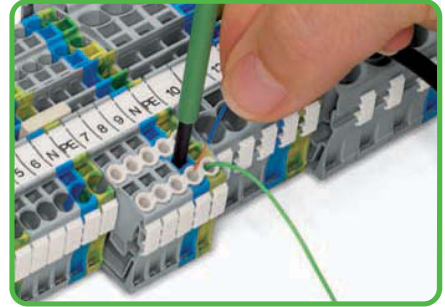

Conductor termination - Insulation stop.

Simply jumpered



Insert push-in type jumper bar and push down firmly until it hits the backstop.

Customizable push-in type jumper bars



Breaking off jumper contacts (up to 4 mm²/AWG 12)

Customizable push-in type jumper bars



Marking with a felt-tip pen.

CAGE CLAMP®S for all conductor types



Commoning with step-down jumpers

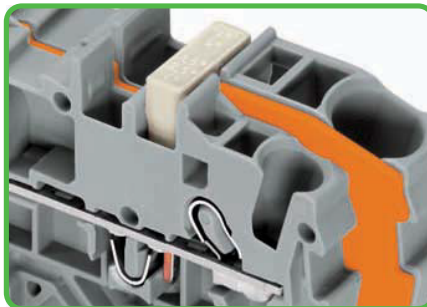

Commoning with step-down jumpers.

Star point jumpers

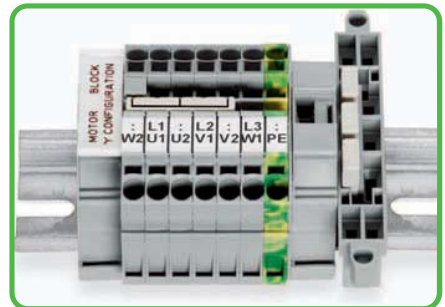

Star point jumpers designed for 'Y' configuration



CAGE CLAMP®S clamps the following copper conductors:*

solid



stranded



fine-stranded, also with tinned single strands

* For aluminum conductors, see notes in Section 14.

- Description and Handling -

Simply smaller



Up to 30% more compact. Advantage: More wiring space or smaller switch cabinets/junction boxes.

TOPJOB®S connectors



The 2001, 2002 and 2004 Series terminal blocks are equipped with a test socket for 2 mm Ø or 2.3 mm Ø test plugs.

Testing tap

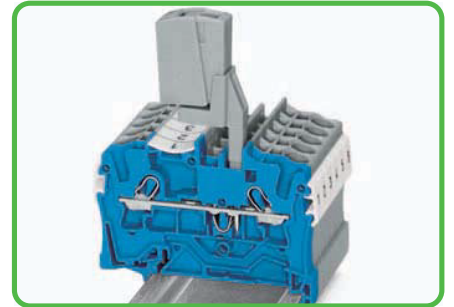

Testing tap suited for 2001 to 2016 Series terminal blocks. Tool-free connections for individual test wires up to 2.5 mm²/AWG 12.



Test plug adapter



The test plug adapter for 4 mm Ø plugs is suited for 2001 to 2016 Series terminal blocks.

Simply marked

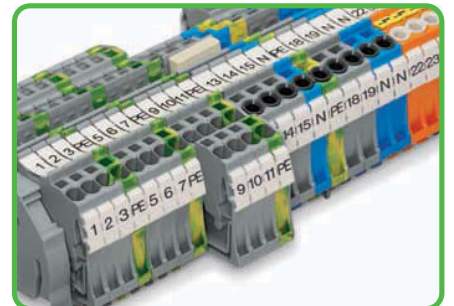

Marker strips for center marking

Wire jumpers

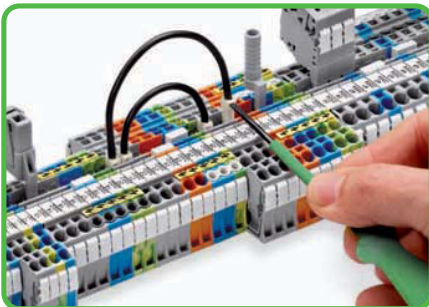

Push down the wire jumper until fully inserted. Lift the jumper with an operating tool for rewiring.

Marking

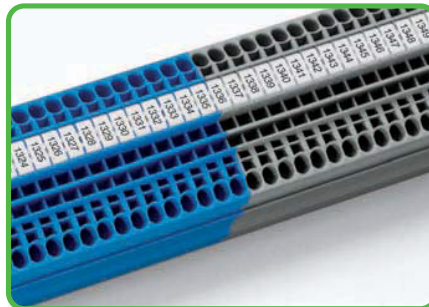

WMB In-line
WMB markers on roll

Marking



TOPJOB®S group marker carrier, snap-on type for jumper slot

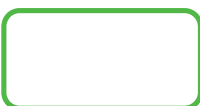

fine-stranded,
tip-bonded

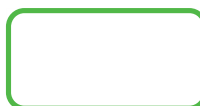

fine-stranded,
with ferrule,
(gastight crimped)

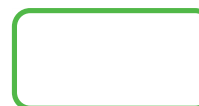

fine-stranded,
with pin terminal
(gastight crimped)

Double-Potential Terminal Blocks 1.5 (2.5) mm² 2001 Series

- ① Conductor sizes: 0.25 mm² - 2.5 mm² "s + f-st";
Push-in conductor sizes: 0.5 mm² - 2.5 mm² "s"
and 0.75 mm² - 1.5 mm²
"insulated ferrule, 12 mm"
- ② 800 V = rated voltage
8 kV = rated surge voltage
3 = pollution degree
(also see Section 14)
- ③ Strip length, see packaging or instructions.
- ④ Suitable for Ex i applications
- ⑤ Suitable for Ex e II applications
550 V, 17 A
Jumper 16 A
(also see Section 14)
- ⑥ See application notes for:
Ex e/Ex i separator plate, page 52
Step-down jumper, page 67
Star point jumper, page 140
Delta jumper, page 140
Push-in type wire jumper, page 140
Banana plug, page 198
TOPJOB®S connector, page 134

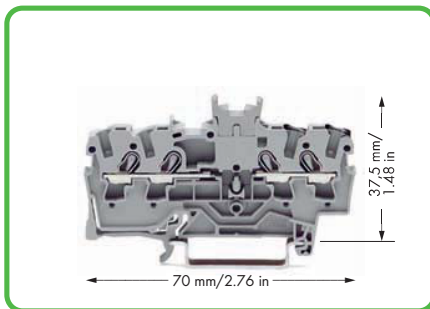

















Double-potential terminal block with double marker slot centered on terminal block
gray 2001-1441
Packing unit: 100 pcs

Notice: This double-potential terminal block cannot be commoned with push-in type jumper bars!

Double-potential terminal blocks are space savers. Two independent feedthrough circuits are placed in one insulated housing on one level in just 4.2 mm/0.165 in. This achieves a width of just 2.1 mm/0.083 in versus standard through terminal blocks. Input and output contacts of one circuit are placed on the same side of the terminal block. Both circuits can be individually marked according to input and output.

For technical data and accessories, see www.wagocatalog.com

2001 Series Accessories		Appropriate marking systems: WMB/Marking strips (see Section 13)	
Delta jumper, insulated,  ⑥ I _N = I _N terminal block, light gray 1-2 3-4 5-6 2001-406/020-000 100 (4x25)	WMB Inline, plain,  stretchable 4 - 4.2 mm, 2,000 WMB markers, 4 mm, on roll white 2009-114 1		
Star point jumper, insulated,  ⑥ I _N = I _N terminal block, light gray 1-3-5 2001-405/011-000 100 (4x25)	WMB Multi marking system,  10 strips with 10 markers per card, stretchable 4 - 4.2 mm plain 793-4501 5		
Push-in type wire jumper,  ⑥ insulated, I _N 16 A, wire size 1.5 mm ² L = 60 mm 2009-412 100 (10x10) L = 110 mm 2009-414 100 (10x10) L = 250 mm 2009-416 100 (10x10)	WMB Multi marking system, plain,  10 strips with 10 markers per card, stretchable 4 - 4.2 mm yellow 793-4501/000-002 red 793-4501/000-005 blue 793-4501/000-006 gray 793-4501/000-007 orange 793-4501/000-012 light green 793-4501/000-017 green 793-4501/000-023 violet 793-4501/000-024 5		
Modular TOPJOB®S connector,  ⑥ can be snapped together, for jumper contact slot gray 2001-511 100 (4x25)			
Spacer module, can be snapped together,  e.g., for bridging commoned terminal blocks gray 2001-549 100 (4x25)	Marking strip, plain,  11 mm wide, 50 m roll white 2009-110 1		
End plate,  for modular TOPJOB®S connectors, 1.5 mm thick gray 2002-541 100 (4x25)	Screwless end stop,  for DIN 35 rail, 6 mm wide gray 249-116 100 (4x25)		
Test plug adapter,  for test plug 4 mm Ø gray 2009-174 100 (4x25)	Screwless end stop,  for DIN 35 rail, 10 mm wide gray 249-117 50 (2x25)		
Banana plug,  ⑥ for socket 4 mm Ø, color mixed 215-111 50			
Testing tap,  for max. 2.5 mm ² gray 2009-182 100 (4x25)			
Test plug,  with 500 mm cable, 2 mm Ø red 210-136 50			
Test plug,  with 500 mm cable, 2.3 mm Ø yellow 210-137 50			