

- Simply Push-In - Conductor Termination/Removal Handling Ex e/Ex i Separators

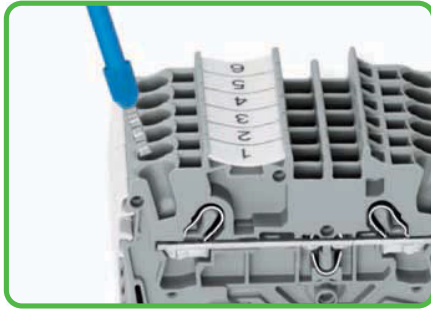

Tool-Free Terminations

Stripped solid, ferruled or ultrasonically "bonded" conductors are easily terminated by simply pushing them into a contact. This advantage significantly reduces costs for conductors rated 0.5 mm² to 16 mm² (AWG 20-4) in applications such as electrical installations or factory wiring.



Stranded conductors with ferrules

from at least two sizes below the rated cross section up to the rated cross section can also be simply pushed in - without tools.

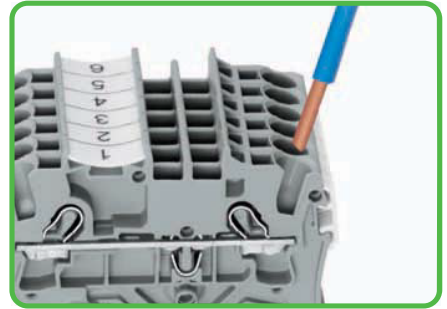

Conductor termination - Push-in connection

Solid conductors with cross sections from either one size above, or up to two sizes below, the rated cross section can be inserted directly - without tools.

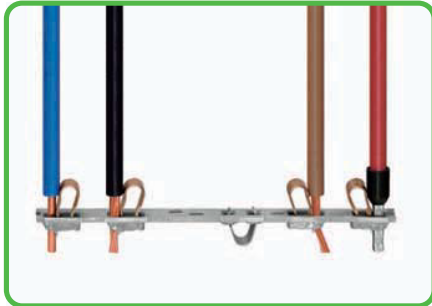

All conductor types at a glance



Conductor termination with operating tool

Connecting fine-stranded conductors without ferrules, or small cross-sectional conductors that cannot be pushed in, is performed similarly to the original CAGE CLAMP® - just use an operating tool.

The smart feature:

To open the clamp, the operating tool is inserted vertically. The conductor entry is less than 15 degrees resulting in easier wiring.

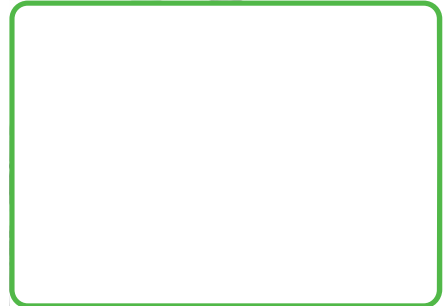

Conductor removal

Like the original CAGE CLAMP®, an operating tool is used for conductor removal with CAGE CLAMP®S.

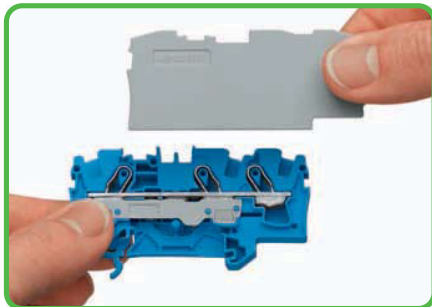

Separator for Ex e/Ex i applications

An end plate must be applied to the terminal block located directly behind an Ex e/Ex i separator plate.



Ex e II/Ex i terminal strip

Notice:
The movable feet of terminal blocks and separator plates must face the same direction.

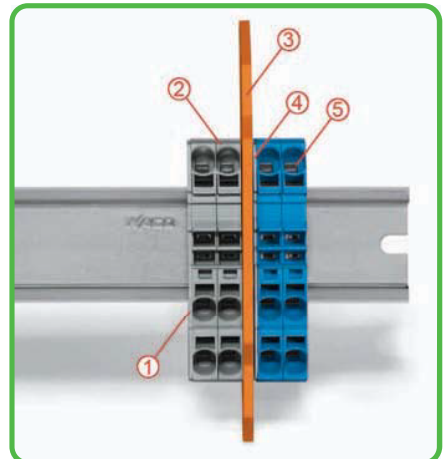

Separator located between Ex e II and Ex i terminal strip

- ① End plate
- ② Ex e II terminal blocks
- ③ Ex e/Ex i separator plate
- ④ End plate
- ⑤ Ex i terminal blocks

- Simply Jumpered - Handling Push-In Type Jumper Bars Angle-Type Rail-Mounted Terminal Blocks



The push-in type jumper system is based on the common plug and socket principle. Each terminal block is spring-loaded with a double socket and a resilient CrNi steel spring. Therefore the jumpers, which consist of cathode copper, can be produced with particularly small dimensions. This does not impair their load carrying capacity in accordance with the terminal block rated current. Ground terminal blocks can also be commoned using the same jumper system. Custom jumpers are created by breaking and removing jumper contacts (4 mm²/AWG 12).

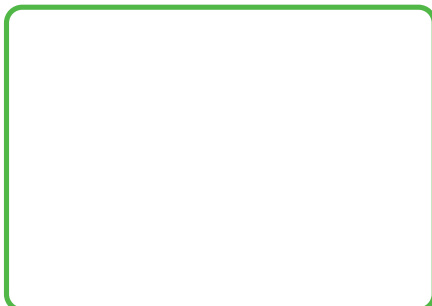

The smart feature:
Jumper slots can also be used for:

- push-in type jumper bars and step-down jumpers
- test plug adapters and testing taps
- preharnessed plugs for subassembly connections.



Push-in type jumper bars
800 V
600 V
550 V

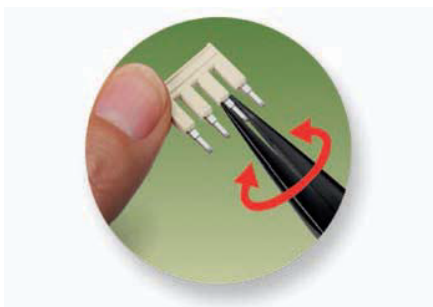

Push-in type jumper bar 1 2 - 4
Breaking off jumper contacts
500 V
300 V



Push-in type jumper bar 1 2 - 4
Marking with a felt-tip pen.

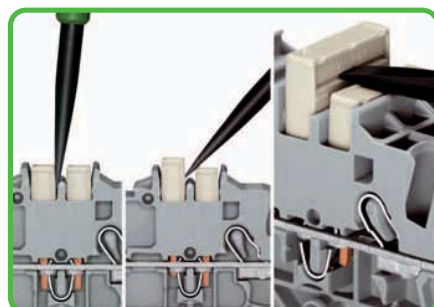

Removal of push-in type jumper bar
Insert the operating tool between the jumper and the partition wall of the dual jumper slots. Place the operating tool in the center of jumpers up to 5 contacts (see above), or alternately on both sides for jumpers with more than 5 contacts.

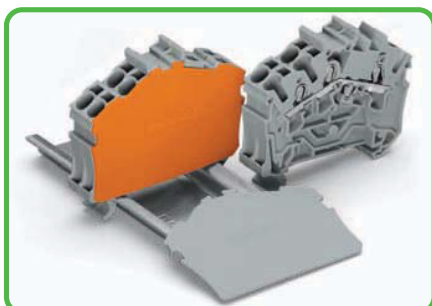

With continuous terminal strips an end plate must be used when changing from 3- to 4-conductor terminal blocks.

Double-Potential Terminal Blocks 2.5 (4) mm² 2002 Series Accessories for Rail-Mounted Terminal Blocks

CAGE CLAMP® S



- ① Conductor sizes: 0.25 mm² – 4 mm² “s + f-st”;
Push-in conductor sizes: 0.75 mm² – 4 mm² “s”
and 0.75 mm² – 2.5 mm²
“insulated ferrule, 12 mm”
- ② 800 V = rated voltage
8 kV = rated surge voltage
3 = pollution degree
(also see Section 14)
- ③ Strip length, see packaging or instructions.
- ④ Suitable for Ex i applications
- ⑤ Suitable for Ex e II applications
550 V, 22 A
Jumper 20 A
(also see Section 14)
- ⑥ See application notes for:
Ex e/Ex i separator plate, page 52
Colored push-in type jumper bars, page 139
Staggered jumper, page 141
Delta jumper, page 140
Star point jumper, page 140
Step-down jumper, page 67
Adjacent jumper for continuous commoning,
page 139
Push-in type wire jumper, page 140
TOPJOB®S connector, page 134
TOPJOB®S L-type test plug module, page 136
Marker carrier, page 145

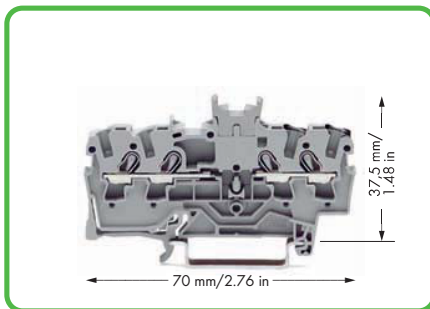

Double-potential terminal block with double marker slot centered on terminal block
gray 2002-1441
Packing unit: 100 pcs



















Notice: This double-potential terminal block cannot be commoned with push-in type jumper bars!

Double-potential terminal blocks are space savers. Two independent feedthrough circuits are placed in one insulated housing on one level in just 5.2 mm/0.205 in. This achieves a width of just 2.6 mm/0.103 in versus standard through terminal blocks. Input and output contacts of one circuit are placed on the same side of the terminal block. Both circuits can be individually marked according to input and output.

For technical data and accessories, see www.wagocatalog.com

2002 Series Accessories

Appropriate marking systems: WMB/Marking strips/WMB Inline
(see Section 13)

Staggered jumper,  insulated, I_N 25 A, light gray 2-way 2002-472 100 (4x25) 3-way 2002-473 100 (4x25) 4-way 2002-474 100 (4x25) 5-way 2002-475 50 (2x25) 6-way 2002-476 50 (2x25) 7-way 2002-477 50 (2x25) 8-way 2002-478 50 (2x25) 9-way 2002-479 50 (2x25) 10-way 2002-480 50 (2x25) 11-way 2002-481 50 (2x25) 12-way 2002-482 50 (2x25)	Push-in type wire jumper,  insulated, I_N 16 A, wire size 1.5 mm ² L = 60 mm 2009-412 100 (10x10) L = 110 mm 2009-414 100 (10x10) L = 250 mm 2009-416 100 (10x10)
Customized staggered jumper,  insulated, I_N 25 A, light gray 1-3 2002-473/011-000 100 (4x25) 1-3-5 2002-475/011-000 100 (4x25) 1-3-5-7 2002-477/011-000 100 (4x25) 1-3-5-7-9 2002-479/011-000 100 (4x25) 1-3-5-7-9-11 2002-481/011-000 50 (2x25)	Modular TOPJOB®S connector,  can be snapped together, for jumper contact slot gray 2002-511 100 (4x25)
Delta jumper, insulated,  $I_N = I_N$ terminal block, light gray 1-2 3-4 5-6 2002-406/020-000 100 (4x25)	Spacer module, can be snapped together,  e.g., for bridging commoned terminal blocks gray 2002-549 100 (4x25)
Star point jumper, insulated,  $I_N = I_N$ terminal block, light gray 1-3-5 2002-405/011-000 100 (4x25)	End plate,  for modular TOPJOB®S connectors, 1.5 mm thick gray 2002-541 100 (4x25)
Step-down jumper, insulated,  I_N 32 A light gray 2006-499 50 (2x25)	Test plug adapter,  for test plug 4 mm Ø gray 2009-174 100 (4x25)
Adjacent jumper for continuous commoning,  insulated, I_N 25 A, light gray 2-way 2002-400 100 (4x25)	Testing tap,  for max. 2.5 mm ² gray 2009-182 100 (4x25)
WMB Inline, plain,  stretchable 5 - 5.2 mm, 1,500 WMB markers, 5 mm, on roll white 2009-115 1	TOPJOB®S test plug module,  can be snapped together gray 2002-611 100 (4x25)
	TOPJOB®S spacer, can be snapped together,  e.g., for bridging commoned terminal blocks gray 2002-649 100 (4x25)
	End plate, for modular TOPJOB®S test plugs,  1.5 mm thick gray 2002-641 100 (4x25)
	Marker carrier,  for jumper slots 2002 Series, 5 mm wide gray 2002-161 100 (4x25)
	WMB Multi marking system,  10 strips with 10 markers per card, stretchable 5 - 5.2 mm plain 793-5501 5