

# - Simply Push-In - Conductor Termination/Removal Handling Ex e/Ex i Separators

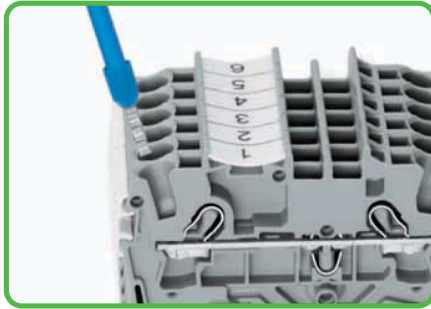

**Tool-Free Terminations**

Stripped solid, ferruled or ultrasonically "bonded" conductors are easily terminated by simply pushing them into a contact. This advantage significantly reduces costs for conductors rated 0.5 mm<sup>2</sup> to 16 mm<sup>2</sup> (AWG 20-4) in applications such as electrical installations or factory wiring.



**Stranded conductors with ferrules**

from at least two sizes below the rated cross section up to the rated cross section can also be simply pushed in - without tools.

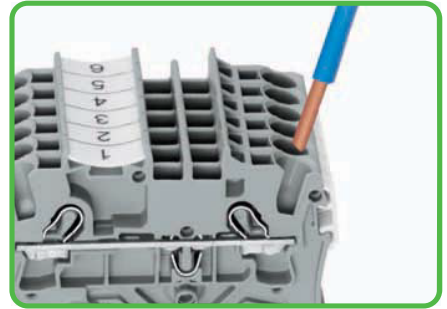

**Conductor termination - Push-in connection**

**Solid conductors** with cross sections from either one size above, or up to two sizes below, the rated cross section can be inserted directly - without tools.

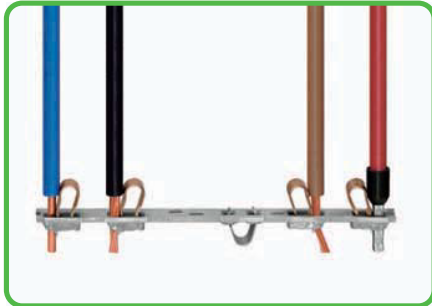

All conductor types at a glance



**Conductor termination with operating tool**

Connecting fine-stranded conductors without ferrules, or small cross-sectional conductors that cannot be pushed in, is performed similarly to the original CAGE CLAMP® - just use an operating tool.

**The smart feature:**

To open the clamp, the operating tool is inserted vertically. The conductor entry is less than 15 degrees resulting in easier wiring.

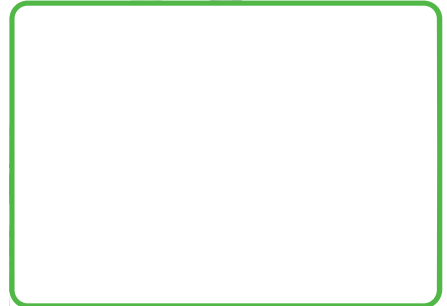

**Conductor removal**

Like the original CAGE CLAMP®, an operating tool is used for conductor removal with CAGE CLAMP®S.

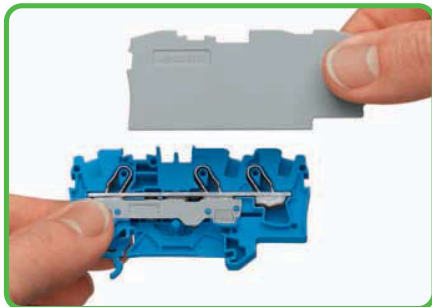

**Separator for Ex e/Ex i applications**

An end plate must be applied to the terminal block located directly behind an Ex e/Ex i separator plate.

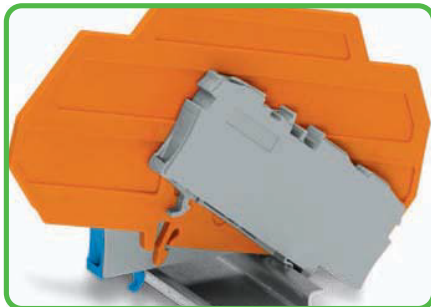

**Ex e II/Ex i terminal strip**

**Notice:**

The movable feet of terminal blocks and separator plates must face the same direction.

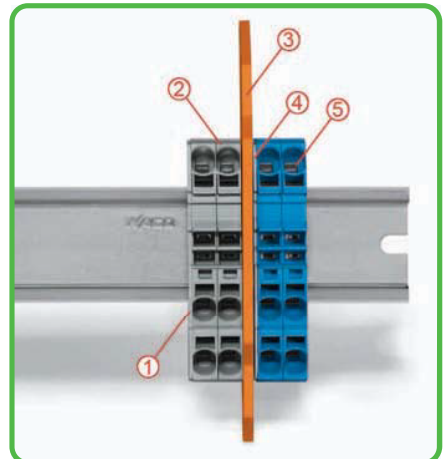

**Separator located between Ex e II and Ex i terminal strip**

- ① End plate
- ② Ex e II terminal blocks
- ③ Ex e/Ex i separator plate
- ④ End plate
- ⑤ Ex i terminal blocks

# - Simply Jumpered - Handling Push-In Type Jumper Bars Angle-Type Rail-Mounted Terminal Blocks



The push-in type jumper system is based on the common plug and socket principle. Each terminal block is spring-loaded with a double socket and a resilient CrNi steel spring. Therefore the jumpers, which consist of cathode copper, can be produced with particularly small dimensions. This does not impair their load carrying capacity in accordance with the terminal block rated current. Ground terminal blocks can also be commoned using the same jumper system. Custom jumpers are created by breaking and removing jumper contacts (4 mm<sup>2</sup>/AWG 12).

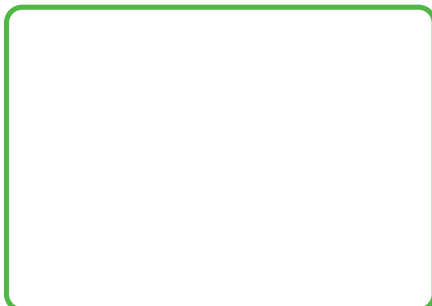



**The smart feature:**  
Jumper slots can also be used for:

- push-in type jumper bars and step-down jumpers
- test plug adapters and testing taps
- preharnessed plugs for subassembly connections.

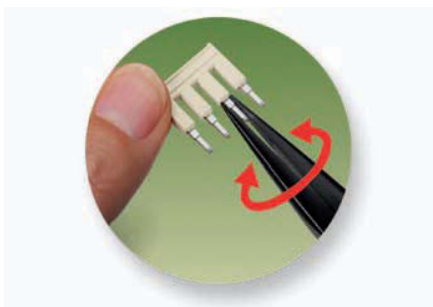

**Push-in type jumper bars**  
800 V  
600 V   
550 V 



**Push-in type jumper bar 1 2 - 4**  
Breaking off jumper contacts  
500 V  
300 V 



**Push-in type jumper bar 1 2 - 4**  
Marking with a felt-tip pen.

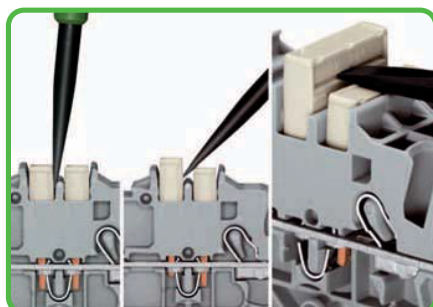

**Removal of push-in type jumper bar**  
Insert the operating tool between the jumper and the partition wall of the dual jumper slots. Place the operating tool in the center of jumpers up to 5 contacts (see above), or alternately on both sides for jumpers with more than 5 contacts.

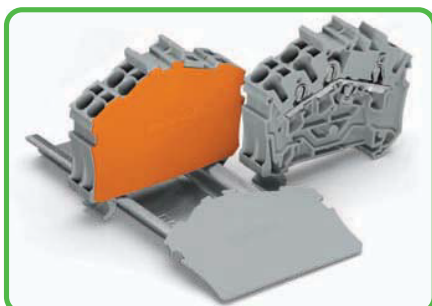

With continuous terminal strips an end plate must be used when changing from 3- to 4-conductor terminal blocks.

# Double-Potential Terminal Blocks 2.5 (4) mm<sup>2</sup> 2002 Series Accessories for Rail-Mounted Terminal Blocks

**CAGE CLAMP® S**



- 1 Conductor sizes: 0.25 mm<sup>2</sup> – 4 mm<sup>2</sup> “s + f-st”;  
Push-in conductor sizes: 0.75 mm<sup>2</sup> – 4 mm<sup>2</sup> “s”  
and 0.75 mm<sup>2</sup> – 2.5 mm<sup>2</sup>  
“insulated ferrule, 12 mm”
- 2 800 V = rated voltage  
8 kV = rated surge voltage  
3 = pollution degree  
(also see Section 14)
- 3 Strip length, see packaging or instructions.
- 4 Suitable for Ex i applications
- 5 Suitable for Ex e II applications  
550 V, 22 A  
Jumper 20 A  
(also see Section 14)
- 6 See application notes for:  
Ex e/Ex i separator plate, page 52  
Colored push-in type jumper bars, page 139  
Staggered jumper, page 141  
Delta jumper, page 140  
Star point jumper, page 140  
Step-down jumper, page 67  
Adjacent jumper for continuous commoning,  
page 139  
Push-in type wire jumper, page 140  
TOPJOB®S connector, page 134  
TOPJOB®S L-type test plug module, page 136  
Marker carrier, page 145

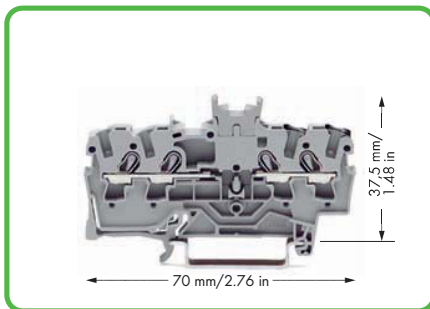

**Double-potential terminal block** with double marker slot centered on terminal block  
gray 2002-1441  
Packing unit: 100 pcs



















**Notice: This double-potential terminal block cannot be commoned with push-in type jumper bars!**

Double-potential terminal blocks are space savers. Two independent feedthrough circuits are placed in one insulated housing on one level in just 5.2 mm/0.205 in. This achieves a width of just 2.6 mm/0.103 in versus standard through terminal blocks. Input and output contacts of one circuit are placed on the same side of the terminal block. Both circuits can be individually marked according to input and output.

For technical data and accessories, see [www.wagocatalog.com](http://www.wagocatalog.com)

## 2002 Series Accessories

Appropriate marking systems: WMB/Marking strips/WMB Inline  
(see Section 13)

<b>Staggered jumper,</b>  insulated, $I_N$ 25 A, light gray 2-way <b>2002-472</b> 100 (4x25) 3-way <b>2002-473</b> 100 (4x25) 4-way <b>2002-474</b> 100 (4x25) 5-way <b>2002-475</b> 50 (2x25) 6-way <b>2002-476</b> 50 (2x25) 7-way <b>2002-477</b> 50 (2x25) 8-way <b>2002-478</b> 50 (2x25) 9-way <b>2002-479</b> 50 (2x25) 10-way <b>2002-480</b> 50 (2x25) 11-way <b>2002-481</b> 50 (2x25) 12-way <b>2002-482</b> 50 (2x25)	<b>Push-in type wire jumper,</b>  insulated, $I_N$ 16 A, wire size 1.5 mm <sup>2</sup> L = 60 mm <b>2009-412</b> 100 (10x10) L = 110 mm <b>2009-414</b> 100 (10x10) L = 250 mm <b>2009-416</b> 100 (10x10)
<b>Customized staggered jumper,</b>  insulated, $I_N$ 25 A, light gray 1-3 <b>2002-473/011-000</b> 100 (4x25) 1-3-5 <b>2002-475/011-000</b> 100 (4x25) 1-3-5-7 <b>2002-477/011-000</b> 100 (4x25) 1-3-5-7-9 <b>2002-479/011-000</b> 100 (4x25) 1-3-5-7-9-11 <b>2002-481/011-000</b> 50 (2x25)	<b>Modular TOPJOB®S connector,</b>  can be snapped together, for jumper contact slot gray <b>2002-511</b> 100 (4x25)
<b>Delta jumper, insulated,</b>  $I_N = I_N$ terminal block, light gray 1-2 3-4 5-6 <b>2002-406/020-000</b> 100 (4x25)	<b>Spacer module,</b> can be snapped together,  e.g., for bridging commoned terminal blocks gray <b>2002-549</b> 100 (4x25)
<b>Star point jumper, insulated,</b>  $I_N = I_N$ terminal block, light gray 1-3-5 <b>2002-405/011-000</b> 100 (4x25)	<b>End plate,</b>  for modular TOPJOB®S connectors, 1.5 mm thick gray <b>2002-541</b> 100 (4x25)
<b>Step-down jumper, insulated,</b>  $I_N$ 32 A light gray <b>2006-499</b> 50 (2x25)	<b>Test plug adapter,</b>  for test plug 4 mm Ø gray <b>2009-174</b> 100 (4x25)
<b>Adjacent jumper for continuous commoning,</b>  insulated, $I_N$ 25 A, light gray 2-way <b>2002-400</b> 100 (4x25)	<b>Testing tap,</b>  for max. 2.5 mm <sup>2</sup> gray <b>2009-182</b> 100 (4x25)
<b>WMB Inline, plain,</b>  stretchable 5 - 5.2 mm, 1,500 WMB markers, 5 mm, on roll white <b>2009-115</b> 1	<b>TOPJOB®S test plug module,</b>  can be snapped together gray <b>2002-611</b> 100 (4x25)
	<b>TOPJOB®S spacer,</b> can be snapped together,  e.g., for bridging commoned terminal blocks gray <b>2002-649</b> 100 (4x25)
	<b>End plate, for modular TOPJOB®S test plugs,</b>  1.5 mm thick gray <b>2002-641</b> 100 (4x25)
	<b>Marker carrier,</b>  for jumper slots 2002 Series, 5 mm wide gray <b>2002-161</b> 100 (4x25)
	<b>WMB Multi marking system,</b>  10 strips with 10 markers per card, stretchable 5 - 5.2 mm plain <b>793-5501</b> 5