

INVERTER
Plug-in option
A8NPRT_2P
INSTRUCTION MANUAL

PROFINET communication interface

Doc.Id. HMSI-27-207
Doc.Rev. 1.01

Important User Information

This document is intended to provide a good understanding of the functionality offered by the A8NPRT_2P PROFINET Option Board. The document only describes the features that are specific to the option board. For general information regarding the FR-A800 inverter, consult the FR-A800 inverter design guides.

The reader of this document is expected to be familiar with high level software design, and communication systems in general. The use of advanced PROFINET-specific functionality may require in-depth knowledge in PROFINET networking internals and/or information from the official PROFINET specifications. In such cases, the people responsible for the implementation of this product should either obtain the PROFINET specification to gain sufficient knowledge or limit their implementation in such a way that this is not necessary.

Liability

Every care has been taken in the preparation of this manual. Please inform HMS Industrial Networks AB of any inaccuracies or omissions. The data and illustrations found in this document are not binding. We, HMS Industrial Networks AB, reserve the right to modify our products in line with our policy of continuous product development. The information in this document is subject to change without notice and should not be considered as a commitment by HMS Industrial Networks AB. HMS Industrial Networks AB assumes no responsibility for any errors that may appear in this document.

There are many applications of this product. Those responsible for the use of this device must ensure that all the necessary steps have been taken to verify that the applications meet all performance and safety requirements including any applicable laws, regulations, codes, and standards.

HMS Industrial Networks AB will under no circumstances assume liability or responsibility for any problems that may arise as a result from the use of undocumented features, timing, or functional side effects found outside the documented scope of this product. The effects caused by any direct or indirect use of such aspects of the product are undefined, and may include e.g. compatibility issues and stability issues.

The examples and illustrations in this document are included solely for illustrative purposes. Because of the many variables and requirements associated with any particular implementation, HMS Industrial Networks AB cannot assume responsibility for actual use based on these examples and illustrations.

Intellectual Property Rights

HMS Industrial Networks AB has intellectual property rights relating to technology embodied in the product described in this document. These intellectual property rights may include patents and pending patent applications in the US and other countries.

Trademark Acknowledgements

Anybus® is a registered trademark of HMS Industrial Networks AB. All other trademarks are the property of their respective holders.

 **CAUTION**

- This is a class A product. In a domestic environment this product may cause radio interference in which case the user may be required to take adequate measures.
- **ESD Note**
This product contains ESD (Electrostatic Discharge) sensitive parts that may be damaged if ESD control procedures are not followed. Static control precautions are required when handling the product. Failure to observe this may cause damage to the product.

A8NPRT_2P PROFINET Option Board Instruction Manual

Rev 1.01

Copyright© HMS Industrial Networks AB

November 2014 Doc Id HMSI-27-207

1.01 Thank you for choosing this Mitsubishi Inverter plug-in option for the Mitsubishi FR-A800 Series Inverter. This Instruction Manual gives handling information and precautions for use of this equipment. Incorrect handling may cause an unexpected failure or damage. In order to ensure optimal performance, please read this manual carefully prior to use of the equipment.

Please forward this manual to the end user of the equipment.

This section is specifically about safety matters

Do not attempt to install, operate, maintain or inspect this product until you have read through this Instruction Manual and any related documents carefully, and can use the equipment correctly. Do not use this product until you have a full working knowledge of the equipment, safety information and instructions.

In this Instruction Manual, the safety instruction levels are classified into "WARNING" and "CAUTION" levels.



WARNING

Assumes that incorrect handling may cause hazardous conditions, resulting in death or severe injury.



CAUTION

Assumes that incorrect handling may cause hazardous conditions, resulting in moderate or slight injury, or may cause physical damage only.

Please note that even the **CAUTION** level may lead to a serious consequence depending on conditions. Please be sure to follow the instructions of both levels as they are critical to personnel safety.

SAFETY INSTRUCTIONS

Electric Shock Prevention

 **WARNING**

- Do not open any cover on the inverter while power is on or while the inverter is running, as an electrical shock may result.
- Do not operate the inverter with any cover or wiring cover removed, as accidental contact with exposed high-voltage terminals and internal components may occur, resulting in an electrical shock.
- If power is off do not remove any cover except when necessary for wiring or periodic inspection. While any cover is removed, accidental contact with exposed high-voltage terminals and internal components may occur, resulting in an electrical shock.
- Prior to starting wiring or inspection, confirm that input power to the inverter has been switched off via observation of the inverter's display panel. Additionally, wait for at least 10 minutes after removal of input power, and then confirm that all residual voltage has been dissipated by using a voltage meter. Internal DC bus capacitors may contain high voltages for several minutes after removal of input power, resulting in a dangerous situation should anything come into contact with them.
- All personnel involved in the installation or inspection of this equipment should be fully competent to perform the required work.
- Always install plug-in options prior to wiring main power.
- Do not touch the plug-in option with wet hands.
- Do not subject the cables to scratches, excessive stress, heavy loads or pinching.

Injury Prevention

 **CAUTION**

- To prevent explosions or similar damage, apply only the voltages specified in the instruction manual to each terminal.
- To prevent explosions or similar damage, ensure that all cables are properly connected to the correct terminals.
- To prevent explosions or similar damage, observe all wiring polarity indicators.
- To prevent burns from hot components, do not touch the inverter while power is on, or for some time after power is removed.

Additional Instructions

Please note the following points to prevent equipment damage, injury or electrical shock.

Transportation and mounting

 CAUTION

- Do not install or operate the plug-in option if it is damaged or has parts missing.
- Do not stand or rest heavy objects on the equipment.
- Check that the mounting orientation is correct.
- Prevent conductive items such as screws and metal fragments, or flammable substances such as oil from entering the inverter.

Trial run

 CAUTION

- To prevent unexpected equipment movement, confirm and adjust all required parameters prior to starting operation.

Usage

 WARNING

- Do not modify the equipment.
- Do not remove any inverter or option parts unless specifically instructed to do so in this manual.

 CAUTION

- Performing a “parameter clear” or “all parameter clear” will reset all inverter parameters to their factory default settings. After performing one of these operations, remember to reenter any custom parameter values prior to starting operation.
- To prevent damage from electric discharge, always touch a grounded piece of metal prior to touching any equipment.

Maintenance, inspection and parts replacement

 CAUTION

- Do not perform hi-pot tests on the equipment.

Disposal

 CAUTION

- Contact the local or state environmental agency in your area for details on the disposal of electrical components and packaging.

General instruction

For clarity purposes, illustrations in this manual may be drawn with covers or safety guards removed. Ensure all covers and safety guards are properly installed prior to starting operation.

Table of Contents

About This Document	1
Related Documents	1
Download	1
Document History	2
Conventions & Terminology	3
Support	3
1. Pre-Operation Instructions	5
1.1 History	5
1.2 Product Overview	5
1.3 Features.....	6
1.4 Unpacking and Product Confirmation	7
1.4.1 Shipment Confirmation.....	7
1.4.2 Component Overview	7
1.5 Environmental Specifications	8
2. Installation	9
2.1 Pre-installation Instructions	9
2.2 Installation Procedure	9
2.3 Network Connector (RJ45)	12
2.4 LED Indicators	13
3. Get Started	15
3.1 Physical Installation.....	15
3.2 Download GSD file.....	15
3.3 Inverter setup	15
3.4 Profinet Controller setup using CCPU.....	16
3.5 Preparing the GX Works Project	22
3.6 GX Works Telegram 1 example	25
3.7 GX Works Telegram 102 example.....	27
3.8 GX Works Acyclic communication example.....	30
3.8.1 Reading a parameter (Sequence 1).....	30
3.8.2 Reading an array of parameters (Sequence 3).....	34
3.8.3 Changing parameters (Sequence 2).....	36
3.9 GX Works Network Detect.....	39
3.10 TIA Portal Telegram 1 example	40
3.11 TIA Portal Telegram 102 example.....	49

3.12	TIA Portal Acyclic communication example	51
3.12.1	Reading a parameter (Sequence 1)	51
3.12.2	Changing parameters (Sequence 2)	58
3.13	SIMATIC STEP7 example	62
3.13.1	Creating a Configuration	62
3.13.2	Download Configuration to the PLC	67
3.13.3	Run	69
3.14	Parameter Settings	70
3.14.1	Parameter Unit	70
4.	Inverter Settings	71
4.1	Inverter Parameters	71
4.2	Option Board Parameters	72
4.3	Operation Mode Setting	74
5.	Identifying the Option Board	75
5.1	Siemens Primary Setup Tool	75
5.2	IP Address	75
6.	Embedded Web Server	77
6.1	Overview	77
6.2	Authorization	77
6.3	Web Pages	78
6.3.1	Network Interface	78
6.3.2	Parameter Data	81
6.3.3	Drive Monitor	83
7.	File System and FTP Server	85
7.1	General	85
7.2	FTP Server	85
7.2.1	Initiation	85
7.2.2	User Accounts	85
8.	PROFINET Implementation	87
8.1	General	87
8.2	Electronic Data Sheet (GSD)	87
8.3	Fast Start Up	87
8.4	DAP	87
8.5	I&M	88

9.	Data Exchange	89
9.1	General Information	89
9.2	Inverter parameters (Acyclic Data Exchange)	90
9.3	Monitor Data (Acyclic and Cyclic Data Exchange)	90
9.4	Drive Profile Parameters (Acyclic Data Exchange)	93
9.4.1	PROFIdrive Parameters	93
9.4.2	Setpoint- and Actual Value (P915/P916)	94
9.4.3	Signal List (P923)	94
9.4.4	Drive Reset (P972)	94
9.5	General State Diagram	95
9.6	Process Data (Cyclic Data Exchange)	96
9.6.1	General	96
9.6.2	IO Device Structure	96
9.6.3	Signals	96
9.6.4	Telegram Types	98
9.7	Acyclic Data Exchange	100
9.7.1	Explanation of fields used in requests	101
9.7.2	Data format type table	101
9.7.3	Error table	102
9.7.4	Sequence 1: Request parameter value, single	102
9.7.5	Sequence 1: Parameter response positive	102
9.7.6	Sequence 1: Parameter response negative	103
9.7.7	Sequence 2: Change parameter value	103
9.7.8	Sequence 2: Parameter response positive	103
9.7.9	Sequence 2: Parameter response negative	103
9.7.10	Sequence 3: Request parameter value, several array elements	104
9.7.11	Sequence 3: Parameter response positive	104
9.7.12	Sequence 3: Parameter response negative	104
10.	Diagnostics	105
A.	Translation of Signal Numbers	107
B.	Troubleshooting	109
C.	HICP (Host IP Configuration Protocol)	111
C.1	General	111
C.2	Operation	111
D.	Copyright Notices	113
	Index	115

About This Document

For more information, documentation etc., please visit the Mitsubishi Electric website, see section "Download" below.

Related Documents

Document	Author
Installation guideline of Mitsubishi inverter drive	ME
Instruction manual of Mitsubishi inverter drive	ME
GX Configurator-PN 1.03 Software Manual: https://eu3a.mitsubishielectric.com/fa/en/mymitsubishi/download_manager?id=10073	ME

Download

The following websites are available for downloads:

Website	Region
https://eu3a.mitsubishielectric.com	EU
http://www.meau.com/eprise/main/sites/public/Products/Variable_Frequency_Drives/A800/default	Americas
GSD File: https://eu3a.mitsubishielectric.com/fa/en/mymitsubishi/download_manager?id=10169 (MyMitsubishi Login required)	EU
GX Configurator-PN 1.03: https://eu3a.mitsubishielectric.com/fa/en/mymitsubishi/download_manager?id=10069 (MyMitsubishi Login required)	EU
Profinet A800 function blocks: https://eu3a.mitsubishielectric.com/fa/en/mymitsubishi/download_manager?id=10173 (MyMitsubishi Login required)	EU
Sample programs: https://eu3a.mitsubishielectric.com/fa/en/mymitsubishi/download_manager?id=10171 (MyMitsubishi Login required)	EU

Document History

Summary of Recent Changes (... 1.01)

Change	Page(s)
Various changes in screenshots and descriptions	7, 20, 27,41, 43, 44, 49, 50, 62, 83, 85
New telegram type 103	98

Revision List

Revision	Date	Author(s)	Chapter(s)	Description
1.00	03/2014			
1.01	01/2015			

Conventions & Terminology

The following conventions are used throughout this manual:

- Numbered lists provide sequential steps
- Bulleted lists provide information, not procedural steps
- The term 'module' refers to the option board.
- Hexadecimal values are written in the format NNNNh, where NNNN is the hexadecimal value.

Support

mitsubishi electric europe
europa b.v.
german branch
gothaer straÙe 8
d-40880 ratingen
phone: +49 (0) 21 02 / 486-0
hotline: +49 2102 1805 000-765 /-766
fax: +49 (0) 21 02 / 4 86-1 12 0
e-mail: megfa-mail@meg.mee.com
<https://eu3a.mitsubishielectric.com>

mitsubishi electric usa
automation
500 corporate woods parkway
vernon hills, illinois 60061
phone: +1 (0) 847 / 478 21 00
fax: +1 (0) 847 / 478 03 27

mitsubishi electric japan
corporation
tokyo bldg.
2-7-3 marunouchi chiyoda-ku
tokyo 100-8310
phone: +81 (0) 3 / 32 18 31 76
fax: +81 (0) 3 / 32 18 24 22

Please refer to the drive manual for other region contact addresses.

1. Pre-Operation Instructions

1.1 History

The FR-A800 series from Mitsubishi Electric (ME), is a family of frequency inverters. The communication modules, option boards, enabling communication on different industrial networks, are developed and produced by HMS Industrial Networks.

Examples of applications for the frequency inverters are:

- Lifting equipment
- Warehouse systems
- Extruders
- Centrifuges

1.2 Product Overview

The A8NPRT_2P PROFINET Option Board for PROFINET allows information to be transferred seamlessly between an FR-A800 inverter and a PROFINET network with minimal configuration requirements. The option board installs directly onto the inverter's control board, and presents two standard 10BASE-T/100BASE-TX Ethernet ports for connection to the PROFINET network. The interface also hosts an embedded web server, which provides access to inverter information via a standard web browser for remote monitoring, configuration and control.

The option board is connected directly to the control board of the inverter and communicates to the inverter via a built-in communication port. Note that when the inverter's network communication port is used by the A8NPRT_2P PROFINET Option Board, it is unavailable for use by any other network.

Before using the interface, please familiarize yourself with the product and be sure to thoroughly read the instructions and precautions contained in this manual. In addition, please make sure that this instruction manual is delivered to the end user of the product, and keep this instruction manual in a safe place for future reference or unit inspection.

1.3 Features

- Two PROFINET ports
- PROFINET IO communication
- Drive operation according to PROFIdrive V4.1
 - Supports Application class 1 functionality
- Diagnostic support
- SNMP agent
- FTP server
- Web server
- Firmware upgrade functionality¹
- Supports PROFINET Fast Start Up
- 10BASE-T/100BASE-TX full duplex Ethernet interface
- Auto negotiation enabled
- RT communication
- Network loss detection

¹ Instructions are included when downloading a new firmware version.





1.4 Unpacking and Product Confirmation

1.4.1 Shipment Confirmation

Check the enclosed items. Confirm that the correct quantity of each item was received, and that no damage occurred during shipment.

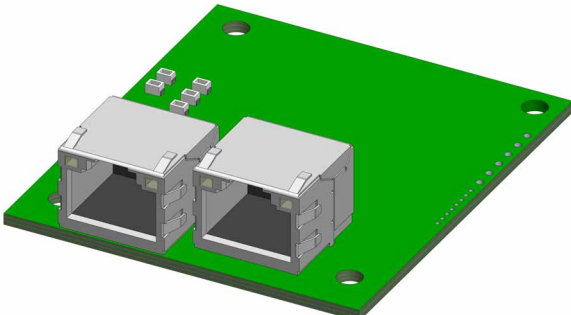
1.4.2 Component Overview

Included in the package are the following items.

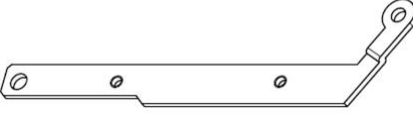
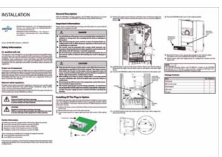
Item	No. of pcs	
PCB board	1	
M3 x 6 mm screw	3	
Board spacer	2	
LED cover	1	
PE plate	1	
Installation sheet	1	



1.5 Environmental Specifications

Item	Specification
Operating Temperature	-10° to +50° Celsius (ambient of the drive, non-freezing)
Storage Temperature	-40° to +65° Celsius
Relative Humidity	93% non1.01 condensing
Vibration	Max acceleration amplitude: 10 m/s ² at 9 - 200 Hz Max displacement amplitude: 3 mm at 2 - 9 Hz
Grounding	Connected to inverter frame ground through the PE plate / isolated from inverter control power common
Power Supply	Supplied from inverter
Cooling Method	Self cooled
Communication Speed	10/100 Mbit

The A8NPRT_2P interface is lead-free / RoHS-compliant.

2. Installation

2.1 Pre-installation Instructions

 WARNING	
	To avoid damage to the inverter or plug-in option board, never install or remove a plug-in option board while the inverter's input power is on. Make sure that the inverter's power is OFF.

Physical installation of the option board is a two-step process. First, the board will be mounted onto an available option connector on the inverter's control board. Second, the board will be connected to the PROFINET network using a network cable.

Note: Prior to mounting the option board in the inverter, please write down the MAC address, which is found on a label on the board.

2.2 Installation Procedure

- ① Make sure that power is off. After switching off the power, wait for at least 10 minutes prior to proceeding with the installation.
- ② Remove both lids of the FR-A800.
 - Unscrew the two screws in the bottom corners of the inverter.
 - Remove the lid covering the lower front of the inverter.
 - Unscrew the screw in the bottom right corner of the lid covering the upper front of the inverter.
 - Remove the lid.

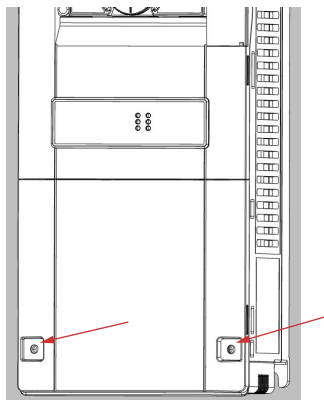

- ③ Put the included board spacers in the holes at the right top and left bottom corners of the PCB.

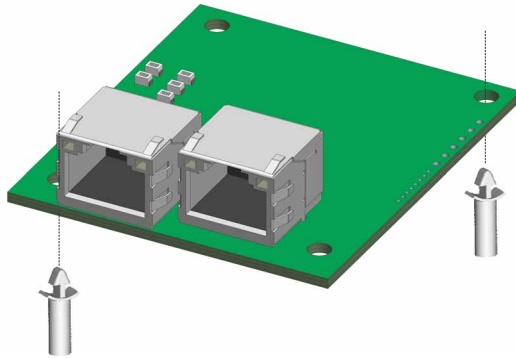

- ④ Position the A8NPRT_2P PROFINET Option Board at the option slot 1 as shown in the image. This is the only position that will allow network connectivity.

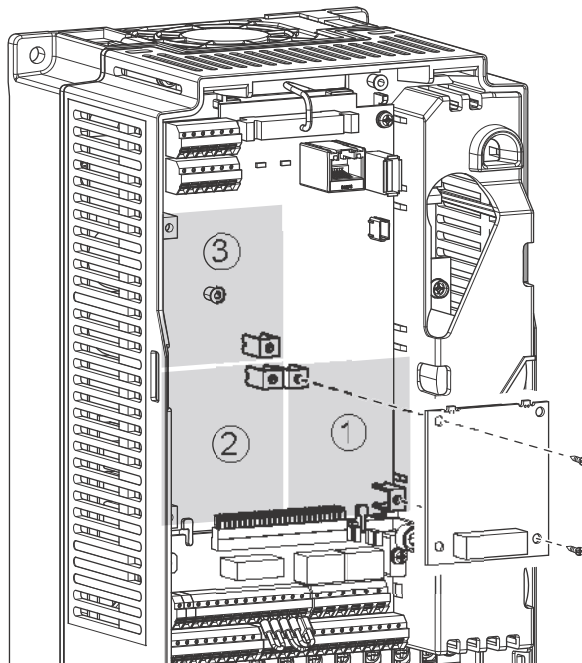

- ⑤ Fasten the option board by tightening the included screws at the top left and bottom right corners. The PE plate is attached along with the screw in the bottom right corner.

Note: Over-tightening the screws will damage the board.

- ⑥ Fasten the other end of the PE plate with another screw as shown in the picture.

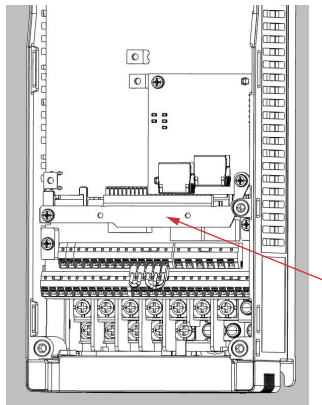

- ⑦ Attach network cable(s) to any of the network connectors on the option board.

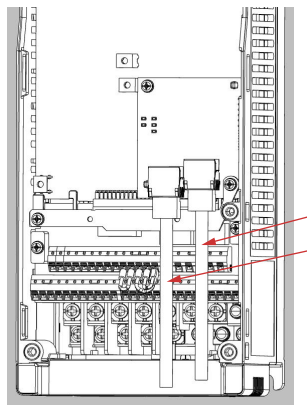

Note: The shield of the RJ45 connector is not connected directly to PE. As all nodes in a PROFINET network have to share chassis ground connection, the PROFINET cable shield has to be connected to the chassis ground at each node in the network. Chassis ground is available in the PE plate.

- ⑧ To fit the LED cover on the front cover of the drive, do as follows:
- Cut the bridges, using nippers, on the upper front cover.

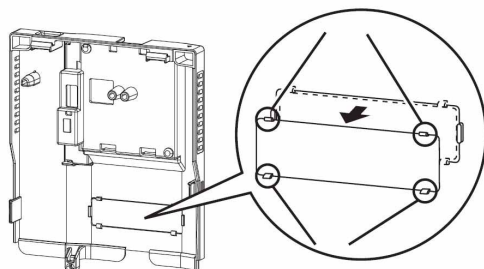

- Snap the LED cover into the front cover of the drive.

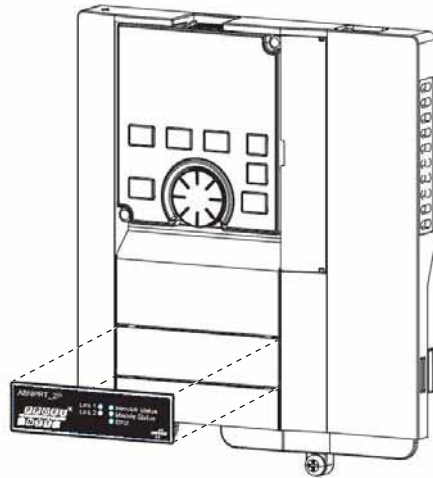

- ⑨ Fasten both front covers, top front cover first.

The option board is now mounted and power can be applied.

Removal

- ① Remove both lids of the FR-A800.
- ② Remove the network cable(s).
- ③ Remove the screws.
- ④ Carefully remove the option board by lifting it straight up.
- ⑤ Remove the board spacers.
- ⑥ Replace the lids.

2.3 Network Connector (RJ45)

The option board provides connection to PROFINET through two identical network connectors.

Pin	Name	Description
1	TX+	Transmit positive
2	TX-	Transmit negative
3	RX+	Receive positive
4	NC	Terminated with a 50-75 Ω resistor
5	NC	
6	RX-	Receive negative
7	NC	Terminated with a 50-75 Ω resistor
8	NC	
Housing	Shield	Filter connection to PE

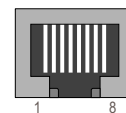

2.4 LED Indicators



LED	State	Status
Network status	Off	Offline: no power or no connection to IO Controller
	Green	Online (RUN): connection to IO Controller established, IO controller in RUN state.
	Flashing Green	Online (STOP): connection to IO Controller established, IO controller in STOP state
Module status	Off	Not initialized: no power or setup not finished
	Green	Operational
	Green, 1 flash	Diagnostic event(s) present
	Green, 2 flashes	Used by engineering tools to identify the node on the network
	Red	Exception error: the option board is in the exception state.
	Red, 1 flash	Configuration error: expected identification differs from real identification.
	Red, 2 flashes	IP Address Error: IP address not set.
	Red, 3 flashes	Station Name not set.
Link (1, 2)	Off	No link: no communication present
	Green	Link: Ethernet link established, no communication present
	Flickering	Activity: Ethernet link established, communication present
Error	Off	Communication with inverter is working without problems.
	Red	Error in communication with inverter
	Red, flashing (2 blinks)	Invalid process data parameter mapped
	Red, flashing (3 blinks)	Too many process data parameters mapped

3. Get Started

All example programs described in this chapter are available for download from the MyMitsubishi website, see section "Download" on page 1 for a direct link.

3.1 Physical Installation

It is recommended to make a note of the MAC address of the option board, prior to installing the module in the inverter. The MAC address can for example be found on the label located on the option board.

The physical installation of the option board is described in "Installation Procedure" on page 9.

3.2 Download GSD file

Download the appropriate GSD file from the Mitsubishi Electric website, see section "Download" on page 1 for a direct link.

3.3 Inverter setup

This chapter describes the first part of setting up a system using an A800 inverter controlled by Profinet. It assumes that the A8NPRT-2P option card has been installed correctly, and all inverter parameters are set to default values. This setup will be used for all get started example programs.

Set parameters 1305 – 1308 as the IP Address of the option board. For this tutorial use address 192.168.3.17 which corresponds to the following settings:

Parameter No.	Value
1305	192
1306	168
1307	3
1308	17

Similarly, set parameters 1309-1312 as the subnet mask 255.255.255.0:

Parameter No.	Value
1309	255
1310	255
1311	255
1312	0

Set parameter 1317 to "1" in order to read the settings from the option board parameters.

Parameter No.	Value
1317	1

The final step is to change the operation mode of the inverter to network. One way to do this is by leaving the default setting of parameter 79 (0), and setting parameter 340 to 1. After restarting the inverter, it should operate in network mode. For detailed settings, please refer to A800 manual.

3.4 Profinet Controller setup using CCPU

This chapter describes setting up a Profinet controller using Q12DCCPU-V for use with the A8NPRT_2P Profinet option card.

- ① For this setup use a Q series PLC with high speed data transfer enabled and a C CPU (Profinet Controller) in a multi CPU setup.

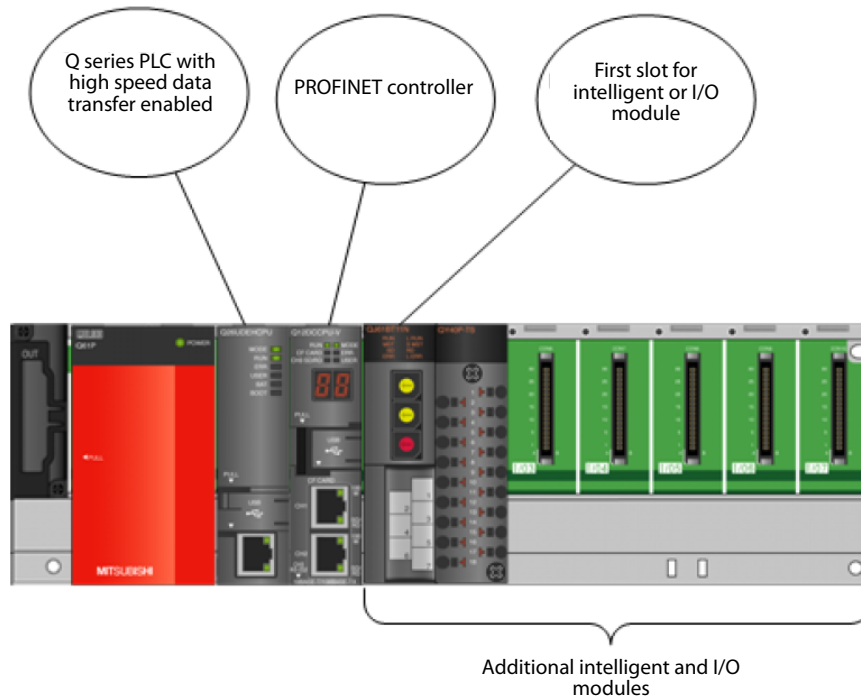

- ② Run GX Configurator PN 1.03 or newer to setup the Profinet controller. Using an Ethernet cable connect the computer to the Profinet controller (CCPU with Profinet software). Select the Ethernet adapter, and click *Detect* to search for the Profinet controller.

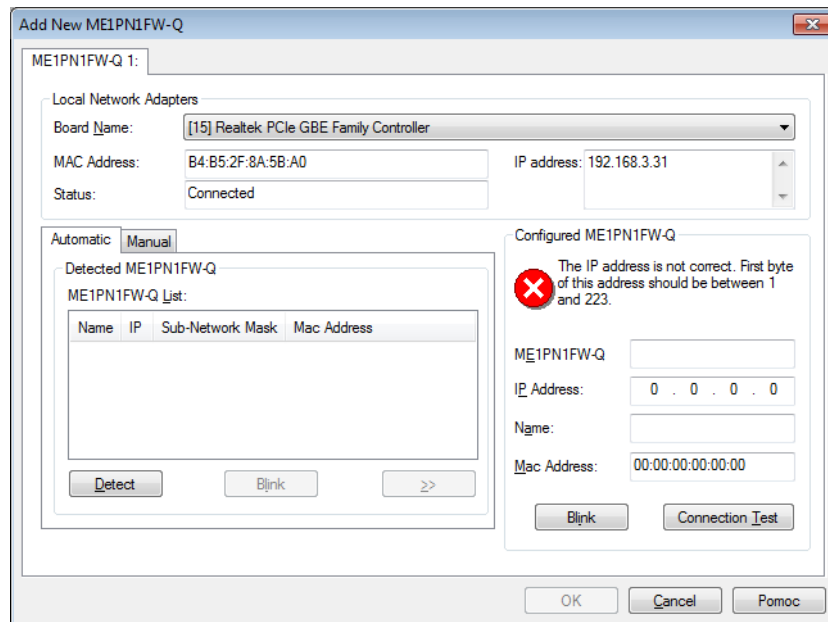

If the controller is not found, check the Ethernet adapter settings to match the settings of the Profinet controller. The default address of the Profinet controller is 192.168.3.3, if the address was changed, and the set address is not recalled, refer to the Profinet controller manual on how to reset to factory settings.

- ③ Once the controller is detected, click on the arrows to copy the controller settings.

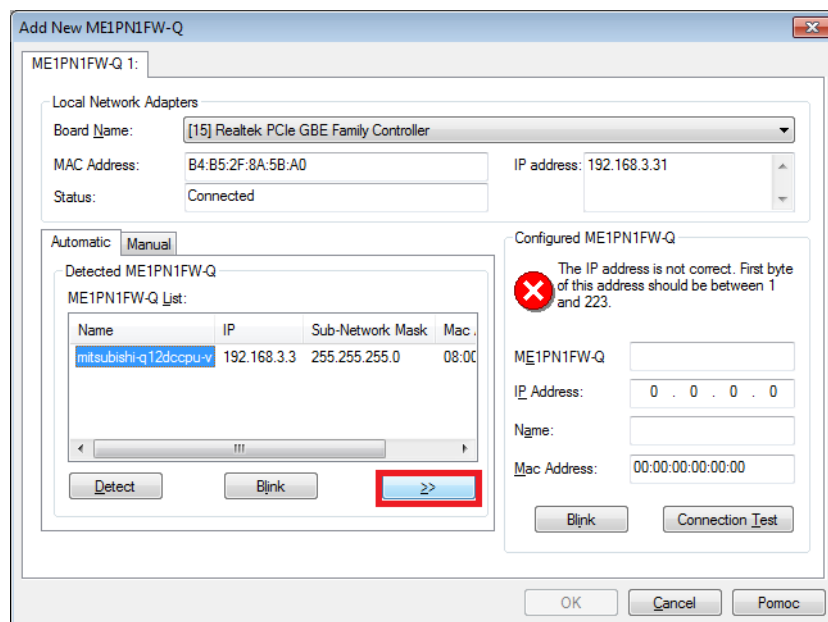

- ④ Finally click on OK to accept the settings.

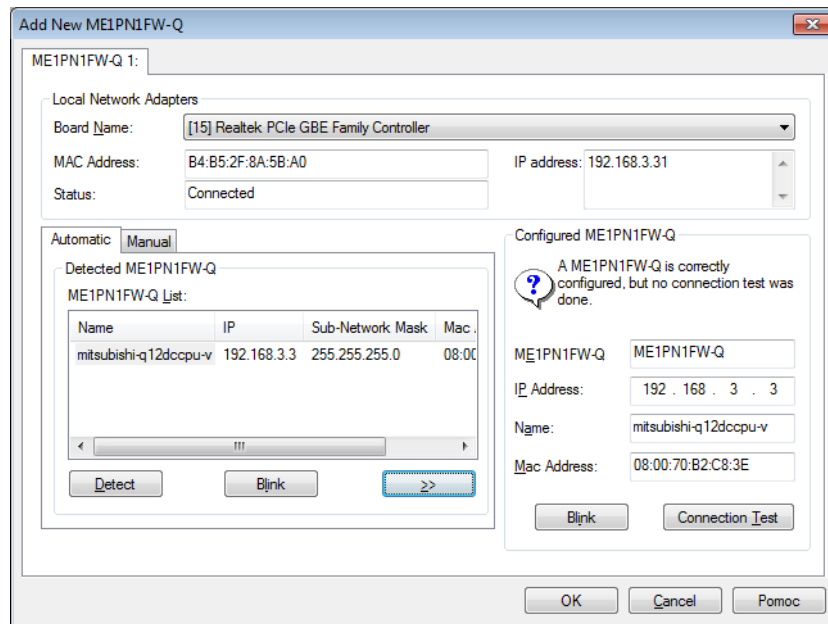

To add the A8NPRT_2P Profinet option card to the device library, right click on the device library, and click add.

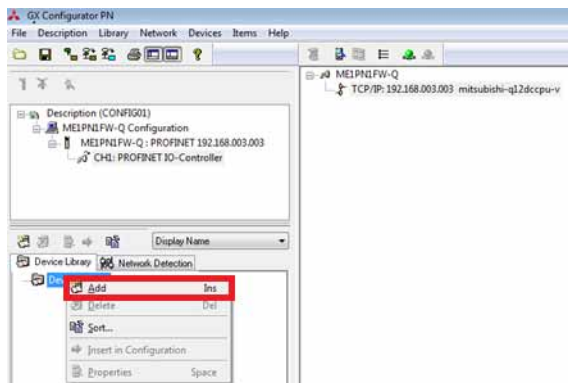

Follow the instructions on screen to add the GSD File supplied with the A8NPRT_2P Profinet option card. If this is done successfully, the device library should look like on the screenshot below.

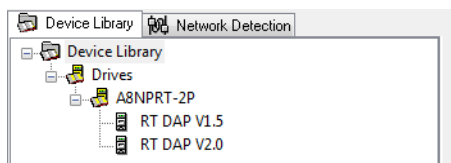

Click on the *Network Detection* tab, then right click on the Network node and select *Online action*.

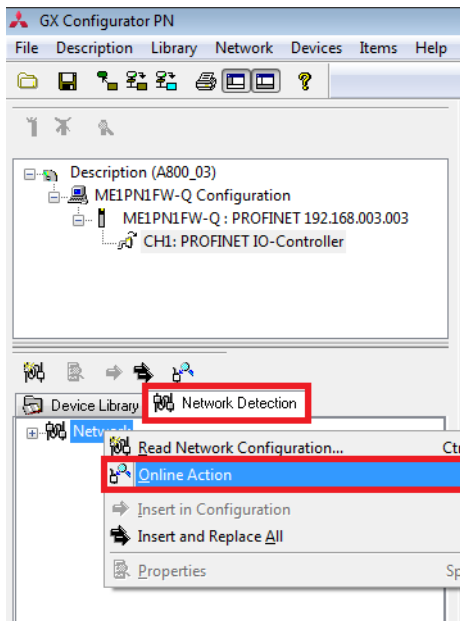

A search of available network devices is performed. Once the A8NPRP-2P Option card is found (look at the *type* column), it is ok to turn off scanning. Apply a Profinet Device Name for the inverter (be sure to check the *Permanent Name* checkbox) and click *Apply Name*. After a successful name change, it is ok to close this window. At this point the option card's Module Status LED should be solid green.

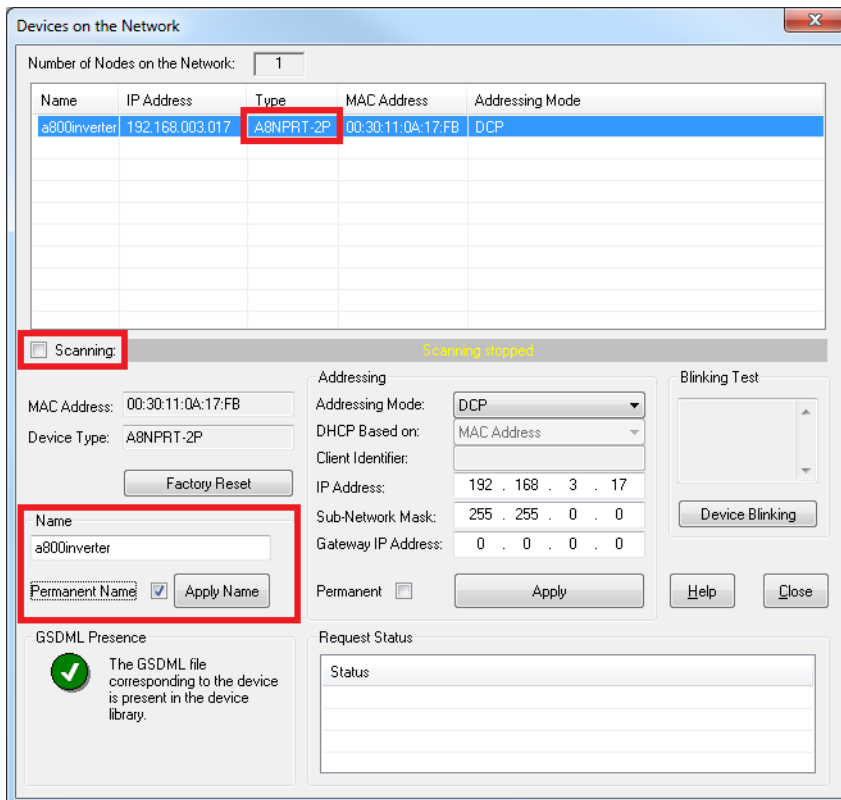

In the *Network Detection* tab right click and select *Read Network Configuration* from the context menu. A prompt asking to accept the PLC settings may be shown; accept the current settings, as they will be changed later on. This will add all Profinet devices to the network tree. Drag the option card to the configuration window.

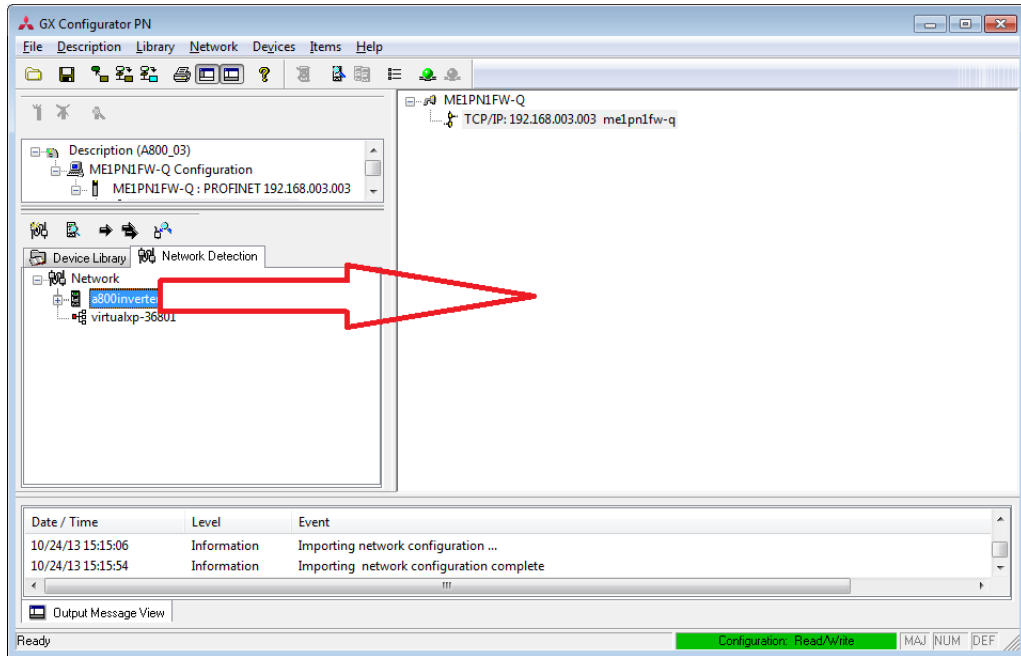

The device parameters will be added to the configuration. Click on the *Module Configuration* tab, and add the *Telegram 1 (PROFdrive)* telegram to the configured module tab.

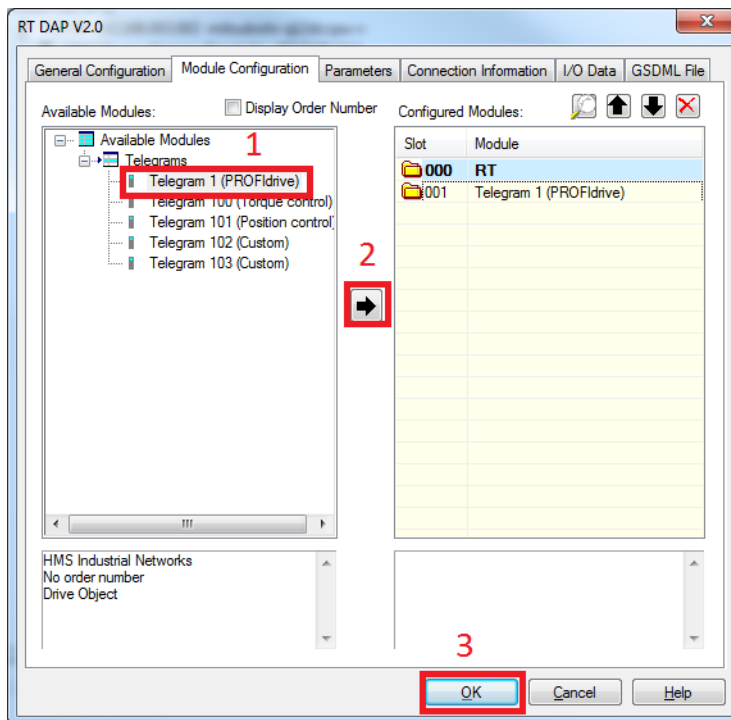

Download the setup to the controller by clicking on *File -> Download configuration*. As a result a message in the *Output message view* at the bottom of the window should be shown.

Enter *File -> PLC Settings* to create the necessary parameter updates. Click on *Configure* to setup the *Multiple CPU Settings*. In the QCPU setup, click on the *PLC Project* entry to modify the path to the PLC project. If the PLC project is not yet created, then do this now. The project must be saved with a GX Works 2 1.502 version or newer. After entering this path, click on *OK* to close the *Multiple CPU settings* window.

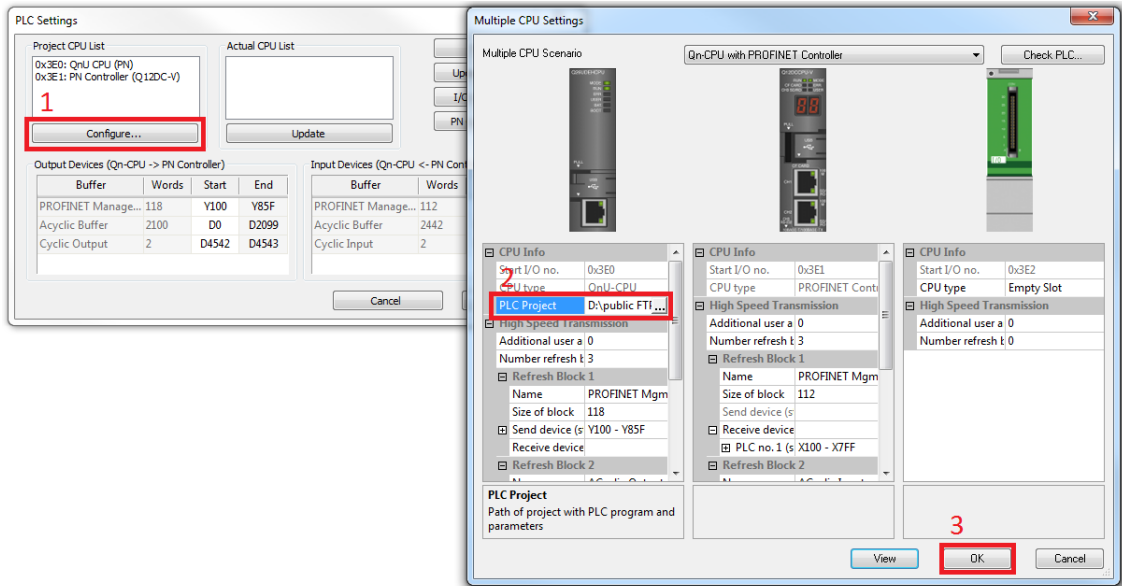

The output and input devices in the PLC Settings can be changed as needed. Make sure none of these devices overlap with devices used in the project. Click on *Update* to update the *Actual CPU List*. To create a connection with the Q PLC, click on *Transfer Setup* and follow the instructions on screen. Now click on *Update parameters...* to update parameters on the QCPU, Profinet Controller and GX Works 2 project. When prompted whether to perform an offline or online and offline update, pick the later.

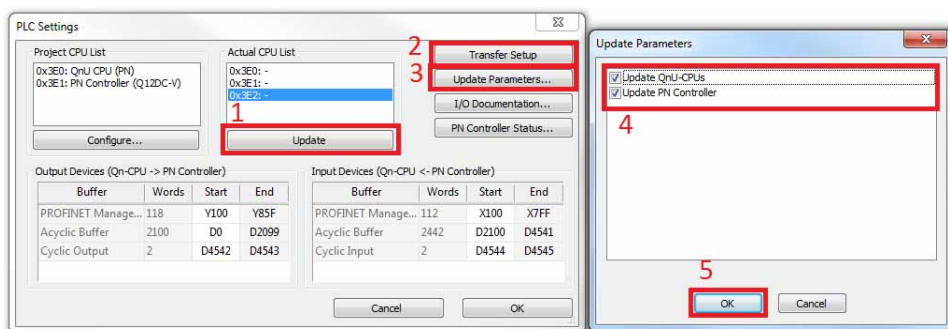

After all three updates finish successfully, the setup of the Profinet controller is complete.

3.5 Preparing the GX Works Project

Open the PLC project updated by GX Configurator PN. If the update was successful, the *I/O Assignment* and *Multiple CPU Setting* tabs of the *PLC Parameter* should be setup.

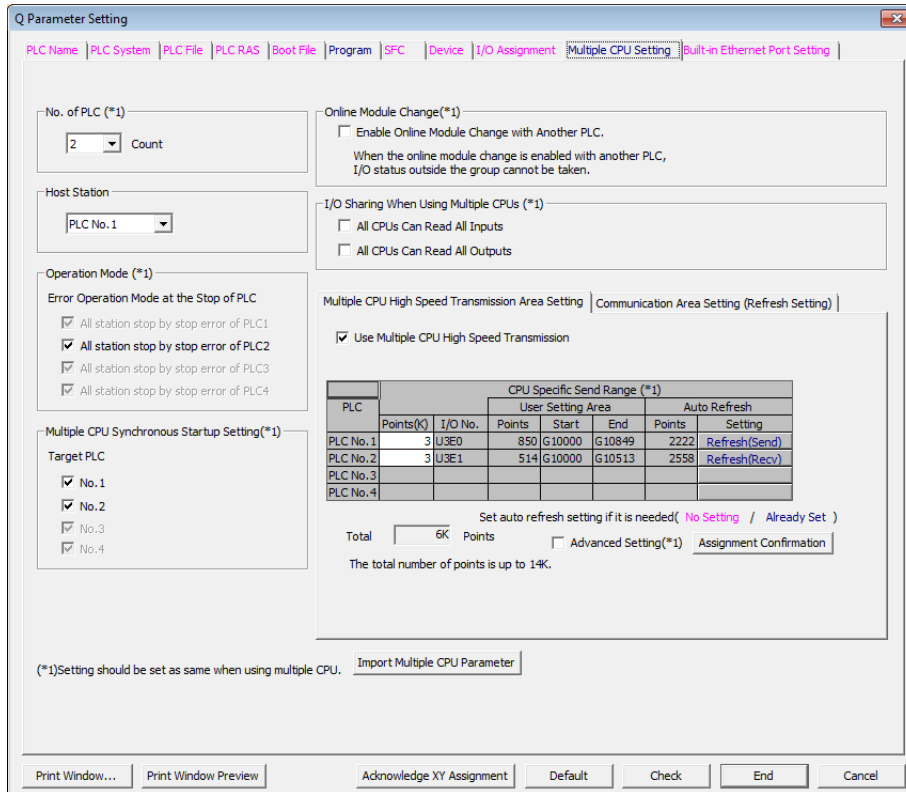

A new library should also be available in the *User library* tab. Click on the lock pad icon to unlock access to the user library.

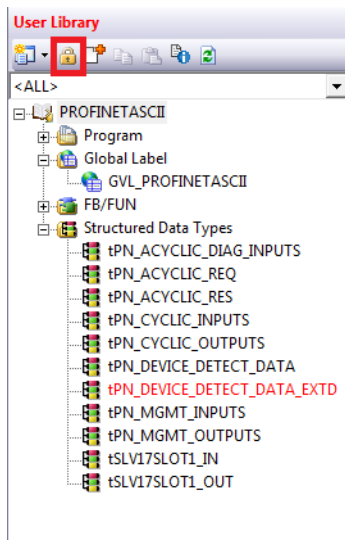

Enter the global label definition file and modify the label names to your liking. The labels must also be modified in the function blocks supplied in this library. The recommended way to do this is to select *Find/Replace => Replace String* from the top menu. Click on *Browse* to select the locations to search for string occurrences. Be sure to select the imported user library. Click on *OK* to return to the previous window. In the *Find String* field enter the current variable name, and in *Replace String* enter the new variable name. Finally click on *All Replace* to replace all occurrences in the user library. Repeat this process for each variable.

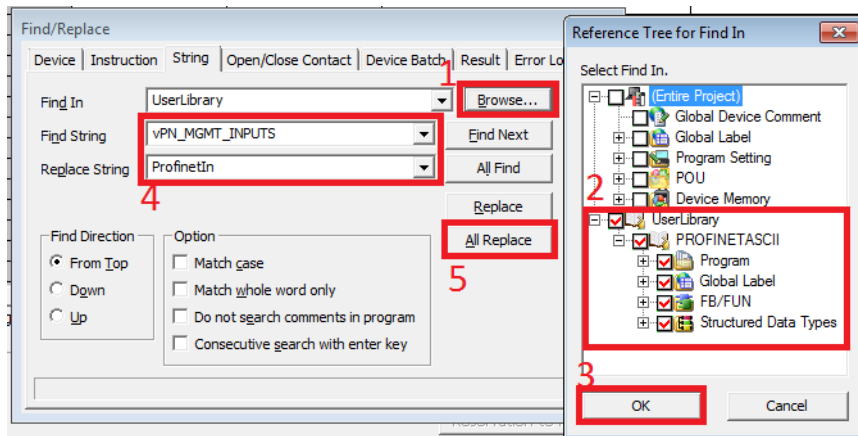

For easier following of the tutorial, it is recommended to follow the naming as on the screenshot below.

	Class	Label Name	Data Type
1	VAR_GLOBAL	a800In	tSLV17SLOT1_IN
2	VAR_GLOBAL	A800Out	tSLV17SLOT1_OUT
3	VAR_GLOBAL	ProfinetOut	tPN_MGMT_OUTPUTS
4	VAR_GLOBAL	ProfinetIn	tPN_MGMT_INPUS
5	VAR_GLOBAL	AcyclicReq1	tPN_ACYCLIC_REQ
6	VAR_GLOBAL	AcyclicReq2	tPN_ACYCLIC_REQ
7	VAR_GLOBAL	AcyclicRes1	tPN_ACYCLIC_RES
8	VAR_GLOBAL	AcyclicRes2	tPN_ACYCLIC_RES
9	VAR_GLOBAL	AcyclicDiag	tPN_ACYCLIC_DIAG_INPUS
10	VAR_GLOBAL	CyclicOut	tPN_CYCLIC_OUTPUTS
11	VAR_GLOBAL	CyclicIn	tPN_CYCLIC_INPUS
12	VAR_GLOBAL	ProfinetDetect	tPN_DEVICE_DETECT_DATA(1..1)
13	VAR_GLOBAL	requestProfinetStart	Bit
14			

Do the same for structured data types *tSLV17SLOT1_IN* and *tSLV17SLOT1_OUT*.

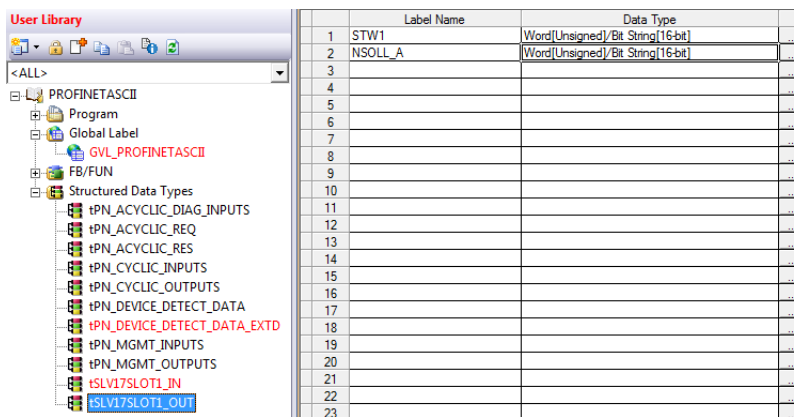
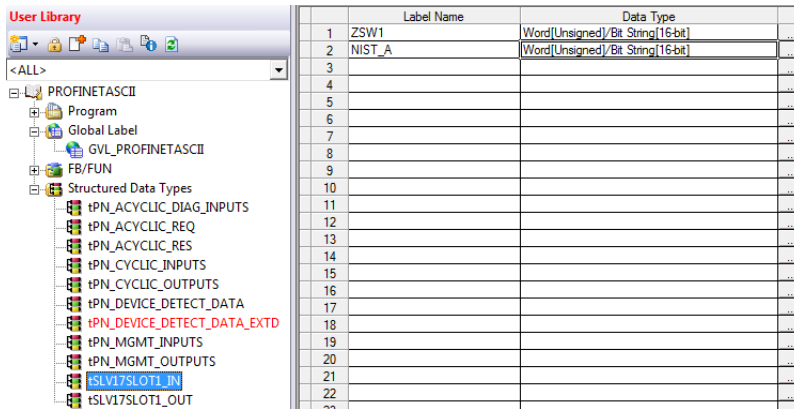

Return to the project tab, and delete the *MAIN* program file from the *Program Setting*, and move the *MAIN1* program file to *Scan Program*. Expand the tree node, and edit the *Init* program. In this ladder program include the initialization procedure for Profinet communication. The ladder program includes auto initialization during PLC startup, as well as on-demand initialization.

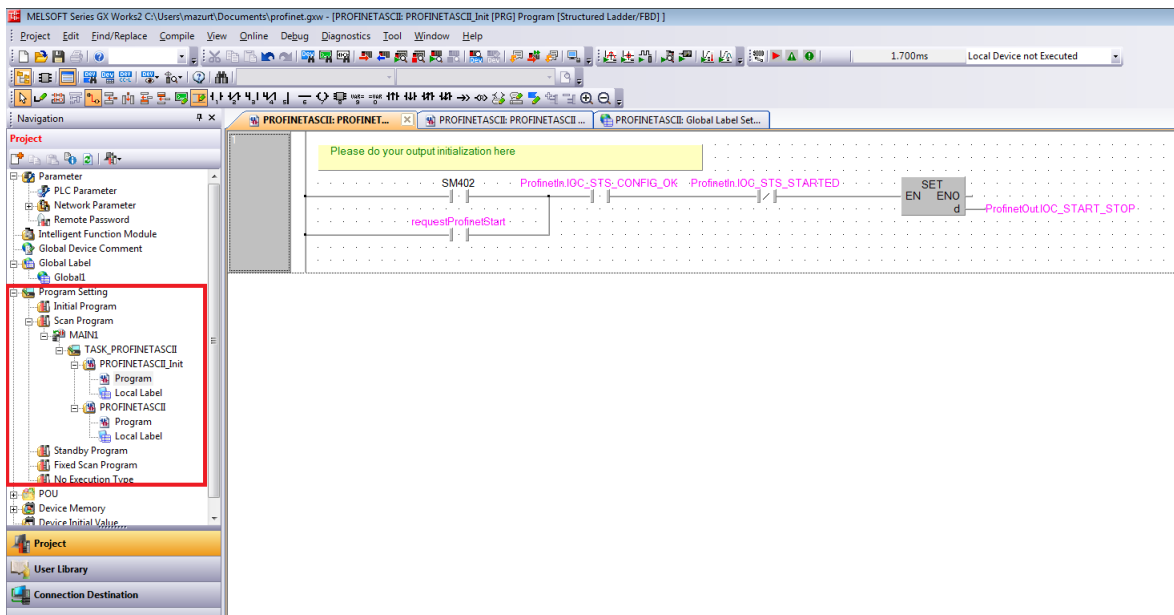

The base program that will be used for all examples is now ready.

3.6 GX Works Telegram 1 example

- ① Start with the project created in the Preparing the GX Works Project chapter. After powering up the inverter and Profinet controller, connection will be established. Expect to see bit 6 (Switching on inhibited) set in ZSW1. Below is a simplified state diagram, dependent on control word 1 (STW1).

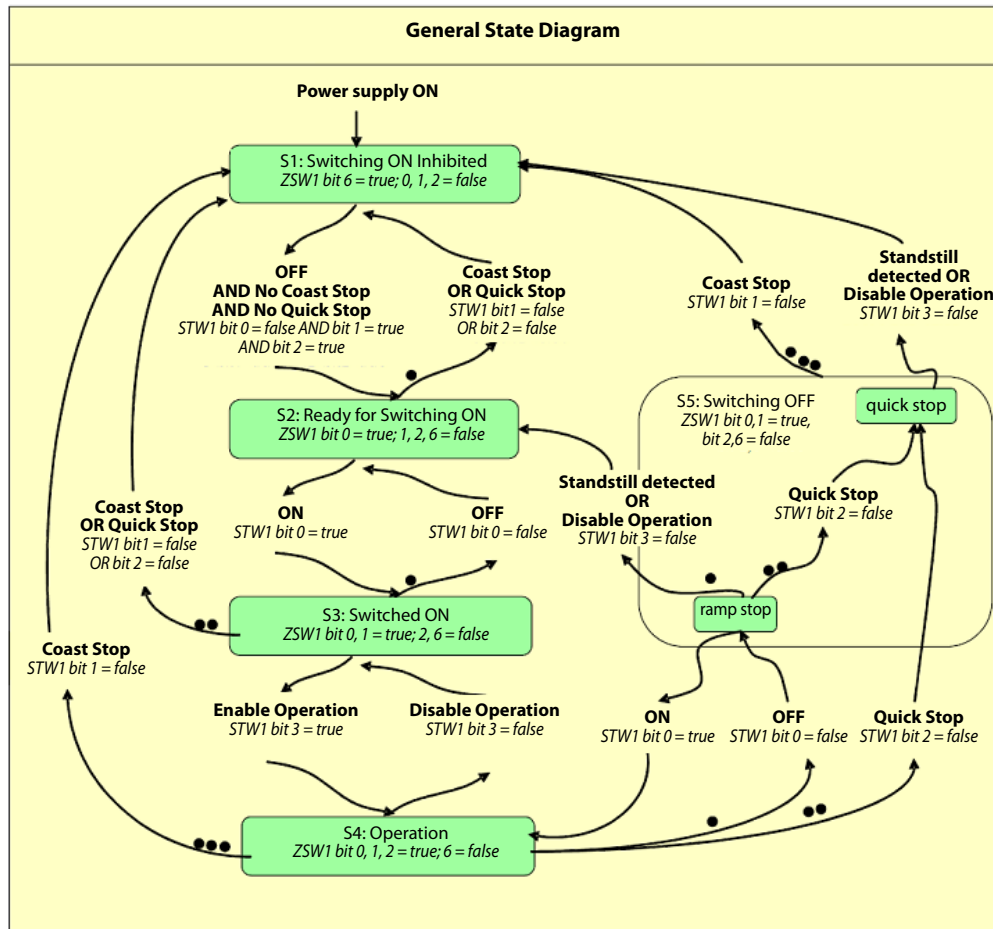

Control Word 1 (STW1) description

State / Bit combination	Bit 10	Bit 7	Bit 3	Bit 2	Bit 1	Bit 0
Description	Control By PLC	Fault acknowledge	Enable operation	No quick stop	No coast stop	On
Switching On Inhibited	-	-	-	-	0	-
	-	-	-	0	-	-
Ready To Switch On	-	-	-	1	1	-
Switched On	-	-	-	1	1	1
Operation	-	-	1	1	1	1
Rotation	1	-	1	1	1	1
Fault reset	-	0 => 1	-	-	-	-

- ② It is needed to set both No Coast Stop and No Quick Stop to reset the Switching On Inhibited bit in ZSW1. To do this set bits 1 and 2 in STW1, that is global label *a800Out.STW1*.

Input the following ladder block to allow the inverter to enter “Ready For Switching On” status, after connection is established, and initialization command is given (M0).

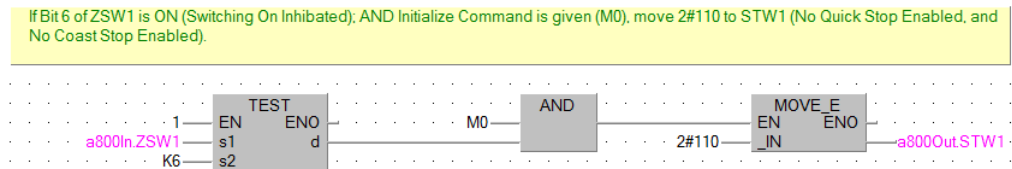

- ③ This initialization will result in setting bit 0 in ZSW1 (Ready To Switch On). The next step is to switch on the inverter, and start operation. To do this enable bits 0 (ON/Off), 3 (enable operation), and 10 (Control By PLC) of STW1; while leaving bits 1 and 2 enabled.

In the same ladder block, set the desired rotation frequency. Assuming the motor is rated for 50 Hz (inverter parameter 3) and a frequency of 10 Hz is the target run frequency (20% of the rated motor speed). The value in Profidrive to allow full power is 16384, so in order to set 20% of the rated motor speed as the run frequency, set value 3277 to the NSOLL_A output (3276,8 round to 3277).

Add the following ladder block to enable rotation command after initialization, and giving rotation command (M1).

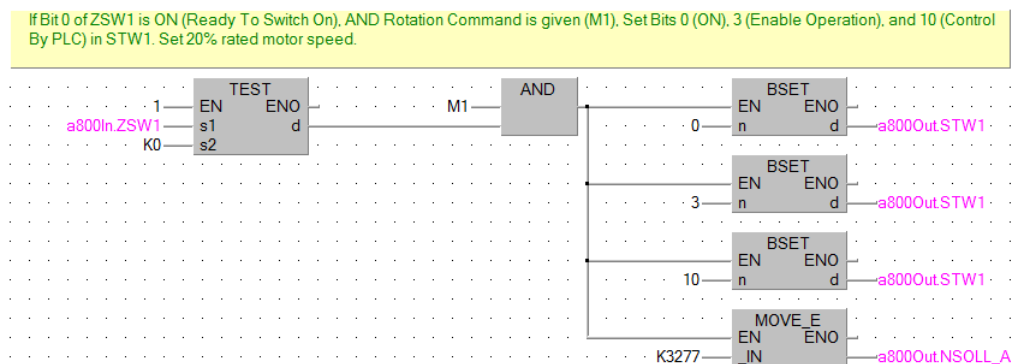

- ④ Finally add the code to stop the drive, when M1 is reset. In a new ladder block, check whether the first 3 bits of ZSW1 are ON. This condition means that the drive is in operation mode. If this condition is met, and M1 is not ON, reset the set point speed to zero, and set STW1 as 6.

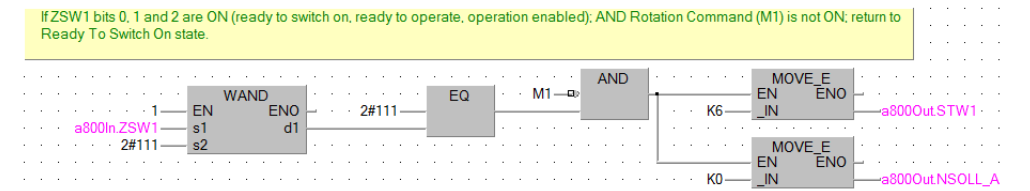

- ⑤ Compile, and write the program and parameters to the PLC. After resetting the PLC, and powering up the inverter, turning on bits M0 and M1 will result in running the inverter with a frequency of 10 Hz.

3.7 GX Works Telegram 102 example

This example builds upon the GX Works Telegram 1 module.

- ① To use Telegram 102, return to GX Configurator PN and update the configuration. Open the previous configuration and double click on the A800 Inverter Profinet device to bring up the configuration window. Click on the *Module Configuration* tab, and select *Telegram 1 (PROFdrive)*. Now click on the red cross to delete this module.

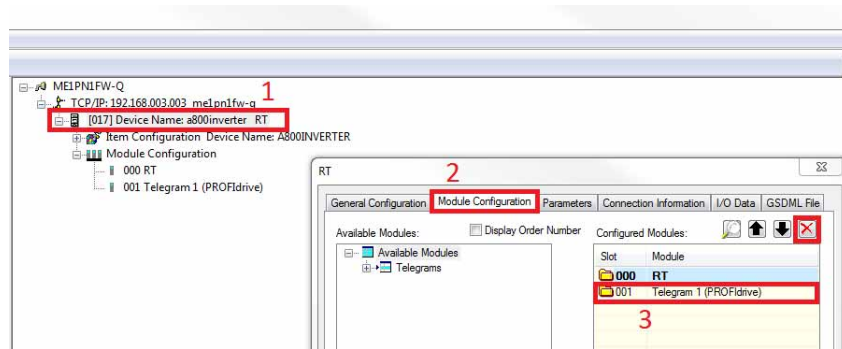

- ② Drag *Telegram 102 (Custom)* from the *Available modules* section to the *Configured modules* section. Now double click on the module to bring up the *Module Configuration* window.

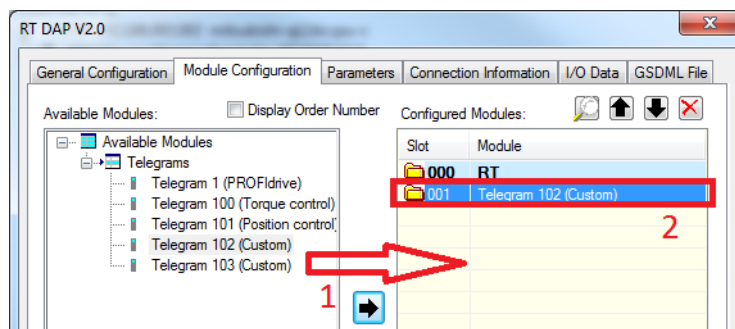

- ③ The setup of the telegram is done by entering signal/parameter numbers into the right column. It is possible to view all monitor data as input, and some of the profile parameters as input/output. Please keep in mind, that not all parameters can be accessed via cyclic communication. The PROFIdrive parameter numbers (PNUs) available for use are listed in the Data Exchange subchapters 9.1 to 9.4. An example setup is provided below:

Slot	Description	PNU
Output PZD/2	Speed set point	14317
Input PZD/2	Actual speed set point	14319
Input PZD/3	Output frequency	9193
Input PZD/4	Output voltage	9195
Input PZD/5	Actual operation time	9215

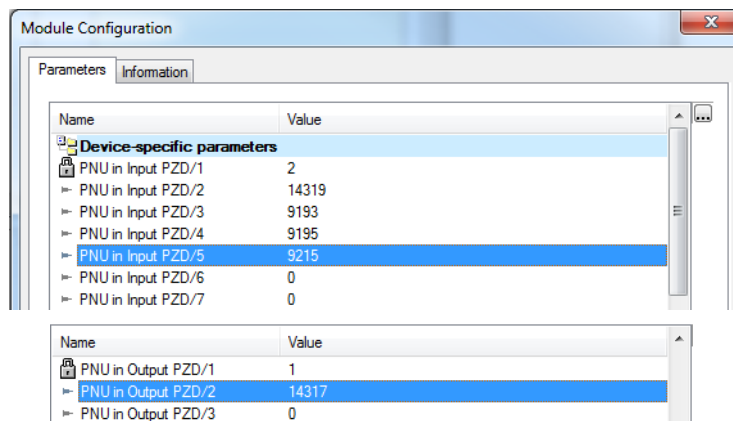

- ④ Finally download the configuration to the device, and update the parameters on the PLC, Profinet controller, and GX Works 2 project. Edit the global labels in the new library to your needs (as shown in chapter Preparing the GX Works Project). Change the names of structured data types *tSLV17SLOT1_IN* and *tSLV17SLOT1_OUT*:

	Label Name	Data Type
1	ZSW1	Word[Unsigned]/Bit String[16-bit]
2	NIST_A	Word[Unsigned]/Bit String[16-bit]
3	OutputFreq	Word[Unsigned]/Bit String[16-bit]
4	OutputVolt	Word[Unsigned]/Bit String[16-bit]
5	OpTime	Word[Unsigned]/Bit String[16-bit]
6	SLOT001_INPUTG	Word[Unsigned]/Bit String[16-bit]
7	SLOT001_INPUTH	Word[Unsigned]/Bit String[16-bit]
8	SLOT001_INPUTI	Word[Unsigned]/Bit String[16-bit]
9	SLOT001_INPUTJ	Word[Unsigned]/Bit String[16-bit]
10	SLOT001_INPUTK	Word[Unsigned]/Bit String[16-bit]
11	SLOT001_INPUTL	Word[Unsigned]/Bit String[16-bit]
12	SLOT001_INPUTM	Word[Unsigned]/Bit String[16-bit]
13	SLOT001_INPUTN	Word[Unsigned]/Bit String[16-bit]
14	SLOT001_INPUTO	Word[Unsigned]/Bit String[16-bit]
15	SLOT001_INPUTP	Word[Unsigned]/Bit String[16-bit]
16	SLOT001_INPUTQ	Word[Unsigned]/Bit String[16-bit]
17	SLOT001_INPUTR	Word[Unsigned]/Bit String[16-bit]
18	SLOT001_INPUTS	Word[Unsigned]/Bit String[16-bit]
19	SLOT001_INPUTT	Word[Unsigned]/Bit String[16-bit]
20	SLOT001_INPUTU	Word[Unsigned]/Bit String[16-bit]
21		
22		
23		
24		
25		
26		
27		
28		
29		

	Label Name	Data Type
1	STW1	Word[Unsigned]/Bit String[16-bit]
2	NSOLL_A	Word[Unsigned]/Bit String[16-bit]
3	SLOT001_OUTPUTD	Word[Unsigned]/Bit String[16-bit]
4	SLOT001_OUTPUTE	Word[Unsigned]/Bit String[16-bit]
5	SLOT001_OUTPUTF	Word[Unsigned]/Bit String[16-bit]
6	SLOT001_OUTPUTG	Word[Unsigned]/Bit String[16-bit]
7	SLOT001_OUTPUTH	Word[Unsigned]/Bit String[16-bit]
8	SLOT001_OUTPUTI	Word[Unsigned]/Bit String[16-bit]
9	SLOT001_OUTPUTJ	Word[Unsigned]/Bit String[16-bit]
10	SLOT001_OUTPUTK	Word[Unsigned]/Bit String[16-bit]
11	SLOT001_OUTPUTL	Word[Unsigned]/Bit String[16-bit]
12	SLOT001_OUTPUTM	Word[Unsigned]/Bit String[16-bit]
13	SLOT001_OUTPUTN	Word[Unsigned]/Bit String[16-bit]
14	SLOT001_OUTPUTO	Word[Unsigned]/Bit String[16-bit]
15	SLOT001_OUTPUTP	Word[Unsigned]/Bit String[16-bit]
16	SLOT001_OUTPUTQ	Word[Unsigned]/Bit String[16-bit]
17	SLOT001_OUTPUTR	Word[Unsigned]/Bit String[16-bit]
18	SLOT001_OUTPUTS	Word[Unsigned]/Bit String[16-bit]
19	SLOT001_OUTPUTT	Word[Unsigned]/Bit String[16-bit]
20	SLOT001_OUTPUTU	Word[Unsigned]/Bit String[16-bit]
21		
22		
23		
24		
25		
26		
27		
28		
29		

The PLC program for telegram 102 is the same as for telegram 1. The library programs will have been overwritten, so it is needed to write them again, or import them from the old telegram 1 project. After this, write the program and parameters to the PLC. Start the inverter in the same way as with telegram 1. Below is a screenshot that shows the input/output variables in the process of speeding up to the set frequency.

Device/Label	Current Value	Data Type	Class	Device	Address	Comment
M0	1	Bit		M0	%MX0.0	
M1	1	Bit		M1	%MX0.1	
a800OutSTW1	1039	Word[Unsigned]/Bit String[16-bit]		D4543	%MW0.4543	
a800OutNSOLL_A	3277	Word[Unsigned]/Bit String[16-bit]		D4544	%MW0.4544	
a800In		Word[Unsigned]/Bit String[16-bit]	VAR_GLOB...			
ZSW1	33335	Word[Unsigned]/Bit String[16-bit]		D4565	%MW0.4565	
NIST_A	1321	Word[Unsigned]/Bit String[16-bit]		D4566	%MW0.4566	
OutFreq	404	Word[Unsigned]/Bit String[16-bit]		D4567	%MW0.4567	
OutVolt	0	Word[Unsigned]/Bit String[16-bit]		D4568	%MW0.4568	
OpTime	11	Word[Unsigned]/Bit String[16-bit]		D4569	%MW0.4569	
SLOTO01_INPUPE	0	Word[Unsigned]/Bit String[16-bit]		D4570	%MW0.4570	
SLOTO01_INPUPE	0	Word[Unsigned]/Bit String[16-bit]		D4571	%MW0.4571	

3.8 GX Works Acyclic communication example

This chapter describes using acyclic communication with the A8NPRT-2 Profinet option card using GX Works 2 with a QCPU and Q12DCCPU-V Profinet controller. It contains examples of reading and writing individual parameters, as well as arrays. First perform the inverter setup, and prepare the GX Works project according to chapter Profinet Controller setup using CCPU.

The process of acyclic communication parameter read consists of a write request, and a response read. For details please refer to the Acyclic Data Exchange subchapter 9.7. These operations are done using function blocks generated by GX Configurator PN. Although it is possible to perform acyclic communication without this library, it exceeds the scope of this manual.

3.8.1 Reading a parameter (Sequence 1)

Creating the request

Start by preparing the content for the parameter read request. The data request has the following format:

Byte no.	Description	Value
0	Request ID	0x01
1	Request reference	0x01-0xFF
2	No. of parameters	0x01
3	DO-ID	0x01
4	No. of elements	0x00
5	Attribute value	0x10 (value attribute)
6-7	Parameter number	Byte swapped PNU

Request reference is any valid number, this value is mirrored back in the response and can be used to distinguish multiple requests. The parameter number needs to be byte swapped (the SWAP instruction can be used to swap the lower and higher byte of a word).

In the code below *requestParameterNo* contains the unswapped parameter number, while *requestParameterNoBS* contains the byte swapped version. The content of the parameter request (*DataToWrite*), and the function block that executes the request (*Write_Rec_Ex*), are shown on the screenshot below:

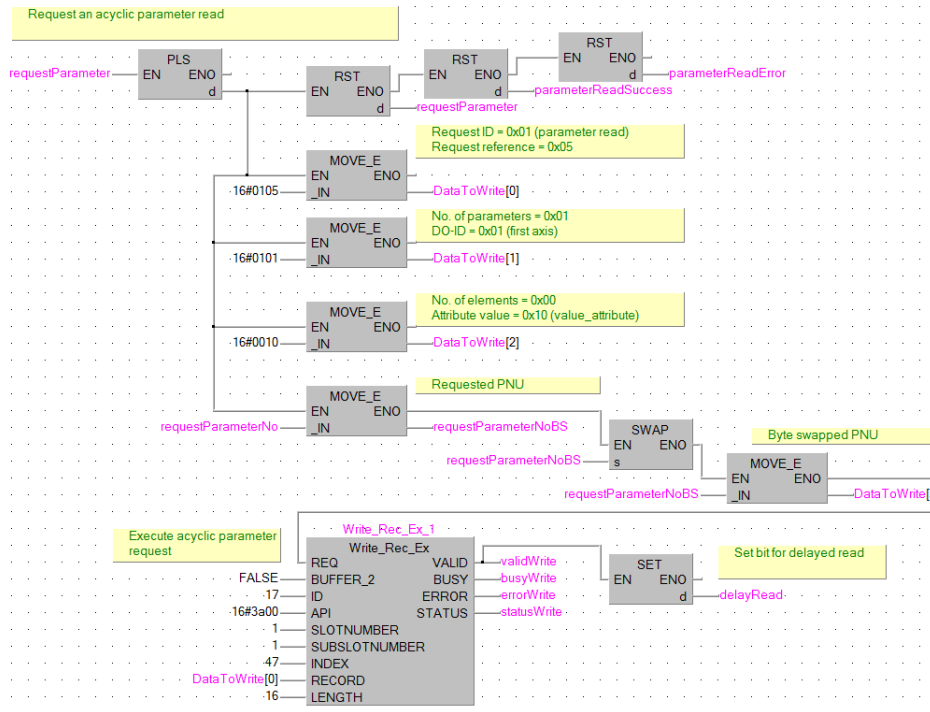

Below is an explanation of the inputs of the function block for this use case:

Write_Rec_Ex input description			
Variable	Type	Description	Value
REQ	Bool	Start write record	FALSE/TRUE
BUFFER_2	Bool	Set to TRUE to use Buffer2	FALSE
ID	DWord	Last octet of the device's IP address	17
API	DWord	API number	0x3a00
SLOTNUMBER	Word	Slot number target	1
SUBSLOTNUMBER	Word	Sub-slot number target	1
INDEX	Word	Index of the record block	47
RECORD	Word	First element of write data	DataToWrite[0]
LENGTH	Int	Write data size in byte	16

Receiving the response

If the request is completed successfully (bit *delayRead* is ON), perform a response read after a delay of 500ms. Due to the nature of Profidrive acyclic communication, the response may not be immediately available after execution of the request. Waiting a small amount of time significantly increases the chance of receiving a response on the first try. Another solution is to keep executing read requests, until a proper read request is received.

It should also be noted, that 240 bytes can always be read. This is the maximum allowed length of a response. In case of a shorter response, only the available data will be read. The inputs for function block *Read_Rec_Ex* are similar to those of *Write_Rec_Ex*. The response data is available on output *RECORD*. The first element of the array that should hold the response should be connected to this output.

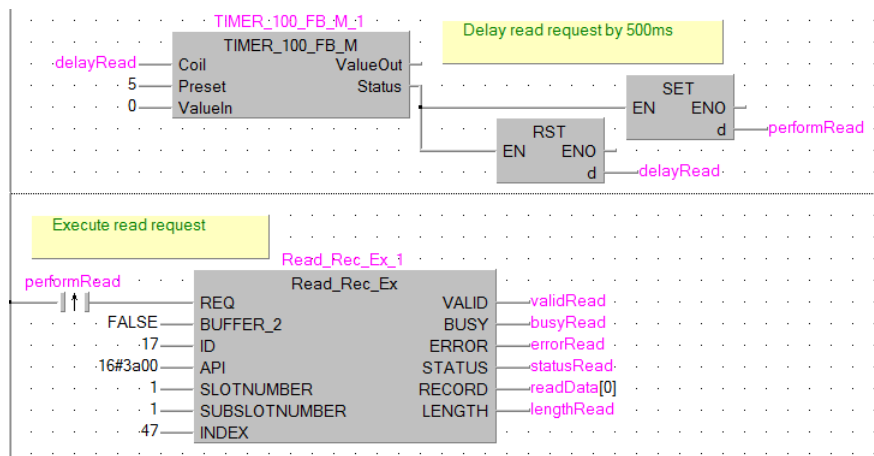

If the response is received successfully (bit *validRead* is ON), then it is possible to access the received data from *readData*. The format of a positive response is as follows:

Byte no.	Description	Value
0	Request ID	0x01
1	Request reference	0x01-0xFF (same as in request)
2	No. of parameters	0x01
3	DO-ID	0x01
4	No. of values	0x01
5	Format	See data format type table
6-7	Parameter value	Byte swapped parameter value

In case of a negative response, the format is as follows:

Byte no.	Description	Value
0	Request ID	0x81
1	Request reference	0x01-0xFF (same as in request)
2	No. of parameters	0x01
3	DO-ID	0x01
4	No. of values	0x01
5	Format	0x44 (error)
6-7	Error value	Byte swapped error value (see error table)

The request ID can be checked to distinguish a positive/negative response. Extract the parameter/error value from *readData*, and byte swap it to receive the actual value:

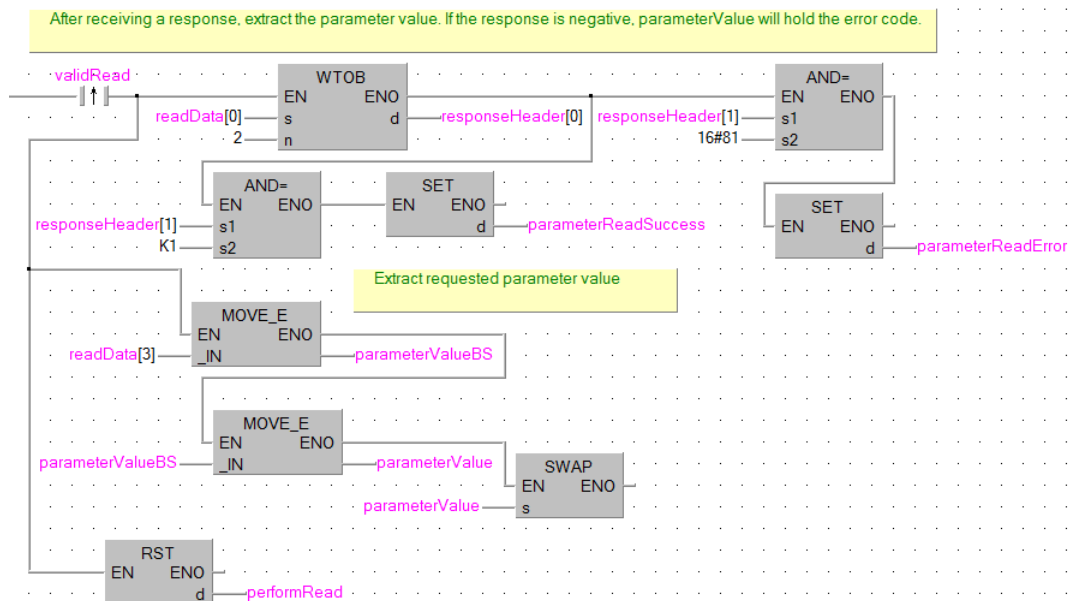

Executing example requests

After compiling the program, and writing it to the PLC, try a parameter read request. The PROFIdrive parameter numbers (PNUs) available for use are listed in the Data Exchange subchapters 9.1 to 9.4. First, get the inverter running by setting bits M0 and M1. Then read the actual frequency by writing PNU 9193 to *requestParameterNo* and setting bit *requestParameter*. The result should be a value of 1000 in *parameterValue* which corresponds to 10Hz.

Device/Label	Current Value	Data Type
M0	1	Bit
M1	1	Bit
PROFINETASCII/requestParameter	0	Bit
PROFINETASCII/requestParameterNo	9193	Word[Unsigned]/Bit String[16-bit]
PROFINETASCII/parameterReadSuccess	1	Bit
PROFINETASCII/parameterReadError	0	Bit
PROFINETASCII/parameterValue	1000	Word[Unsigned]/Bit String[16-bit]

3.8.2 Reading an array of parameters (Sequence 3)

Certain parameters are available in the form of an array. It is possible to access individual elements of the array by changing the subindex. It is also possible to retrieve multiple elements of the array by executing sequence 3. This requires only changing byte no. 4 of the request (No. of values) to the amount of array values wanted. The response will contain additional parameter values added to the end of the response data.

Creating the request

For this example all 5 array elements of PNU 964 (Device identification) will be requested. Modify the parameter request as shown below:

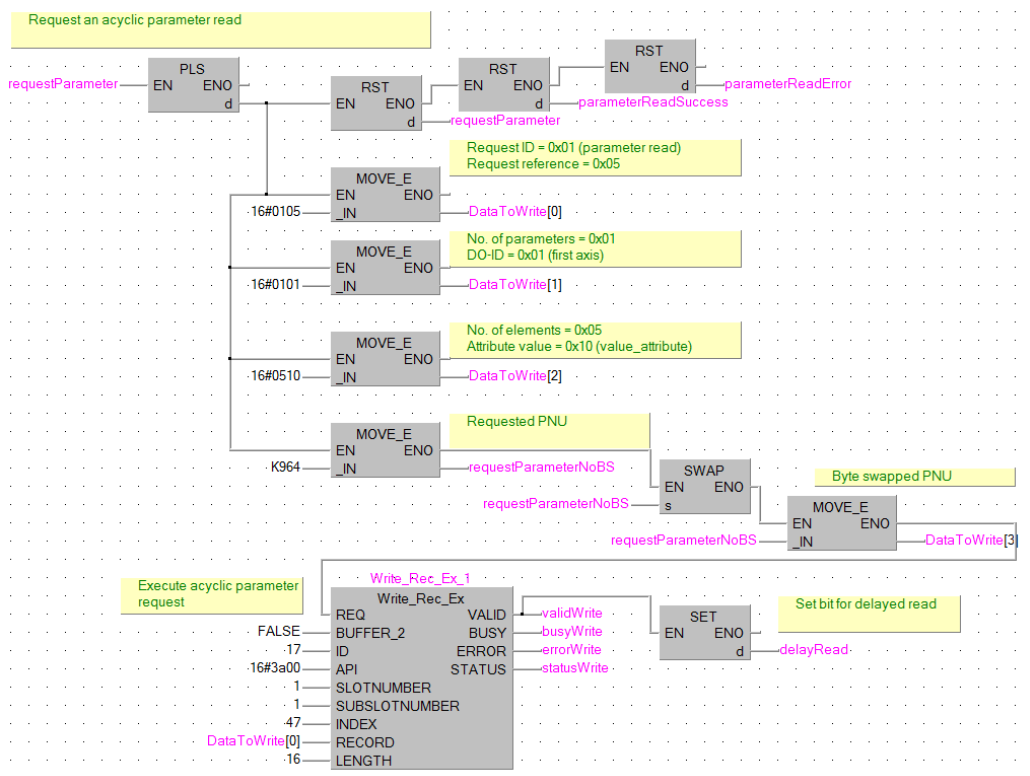

Reading the response

Modify the code reading the response data, to read all 5 elements, and byte swap each one. An example procedure how to do this is shown below. The byte-swapped elements will be available in the array *parameterValue*.

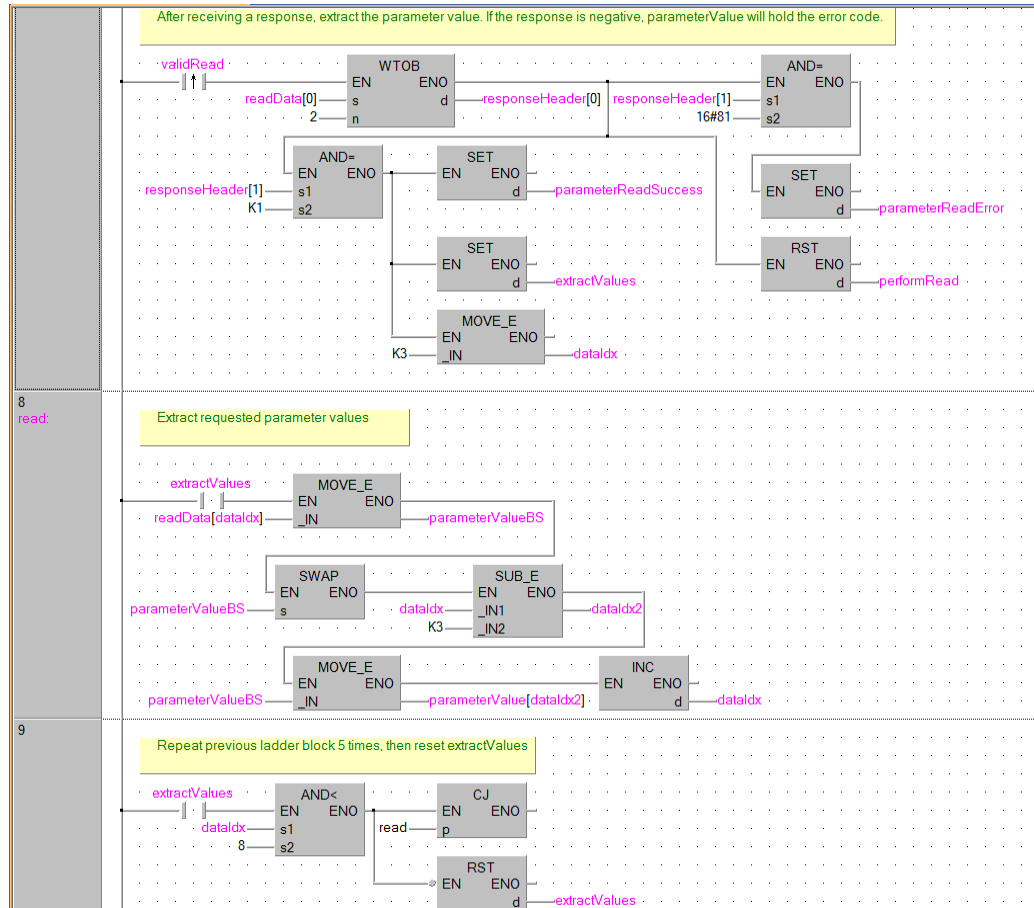

Executing example request

After executing a request, the response data is available in the *parameterValue* variable.

Device/Label	Current Value	Data Type
M0	1	Bit
M1	1	Bit
PROFINETASCII/requestParameter	0	Bit
PROFINETASCII/parameterReadSuccess	1	Bit
PROFINETASCII/parameterReadError	0	Bit
PROFINETASCII/parameterValue		Word[Unsigned]/Bit String[16-bit] [5]
[0]	268	Word[Unsigned]/Bit String[16-bit]
[1]	0	Word[Unsigned]/Bit String[16-bit]
[2]	102	Word[Unsigned]/Bit String[16-bit]
[3]	2013	Word[Unsigned]/Bit String[16-bit]
[4]	2606	Word[Unsigned]/Bit String[16-bit]

3.8.3 Changing parameters (Sequence 2)

Creating the request

The format of the write request is as follows:

Byte no.	Description	Value
0	Request ID	0x02
1	Request reference	0x01-0xFF
2	No. of parameters	0x01
3	DO-ID	0x01
4	No. of elements	0x00
5	Attribute value	0x10 (value attribute)
6-7	Parameter number	Byte swapped PNU
8-9	Subindex (irrelevant)	0x00
10	No. of values	0x01
11	Format	0x06 (UINTeger16 for all inverter parameters) See data format type table
12-13	Set value	Byte swapped set value

Modify the ladder block preparing the content of the request.

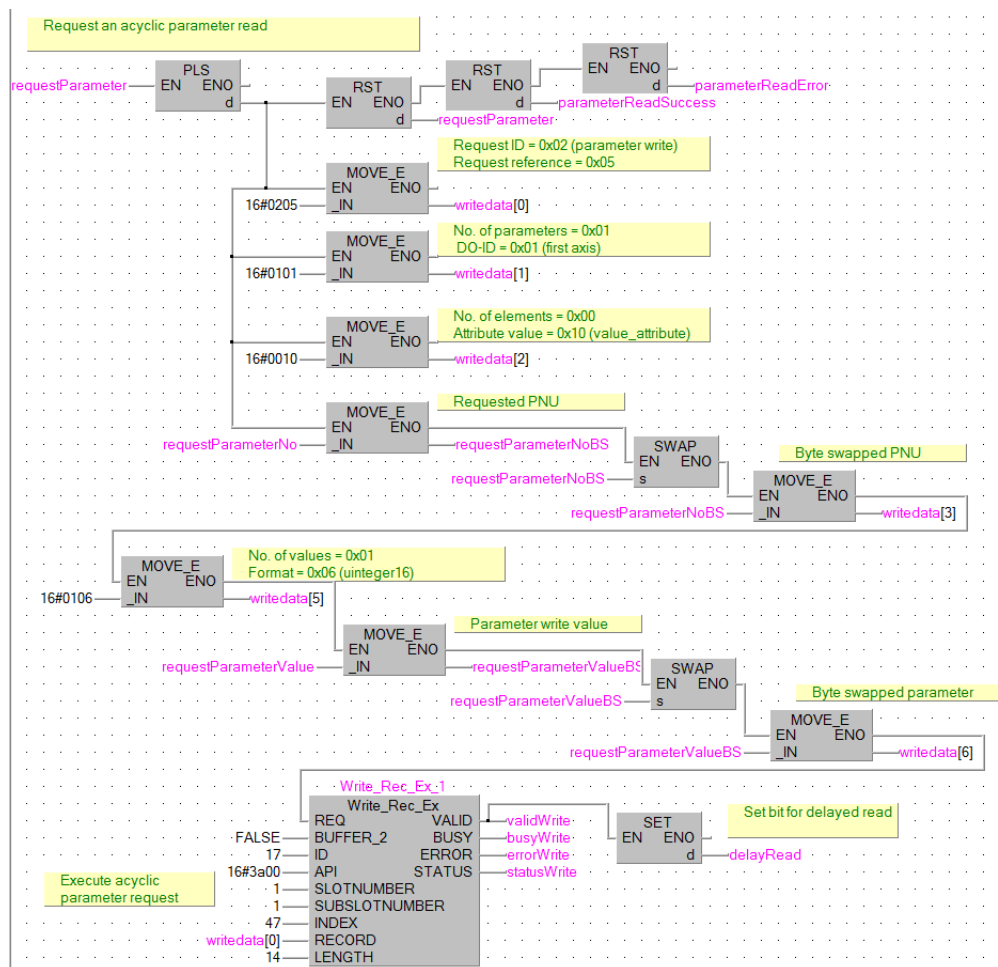

Reading the response

A positive response consists of just 4 bytes of data in the following format:

Byte no.	Description	Value
0	Request ID	0x02
1	Request reference	0x01-0xFF (same as in request)
2	No. of parameters	0x01
3	DO-ID	0x01

In case of a negative response, the format is as follows:

Byte no.	Description	Value
0	Request ID	0x82
1	Request reference	0x01-0xFF (same as in request)
2	No. of parameters	0x01
3	DO-ID	0x01
4	No. of values	0x01
5	Format	0x44 (error)
6-7	Error value	Byte swapped error value (see error table)

Modify the code reading the response data. A successful parameter write is best identified by the request ID. An example procedure how to process the response is shown below.

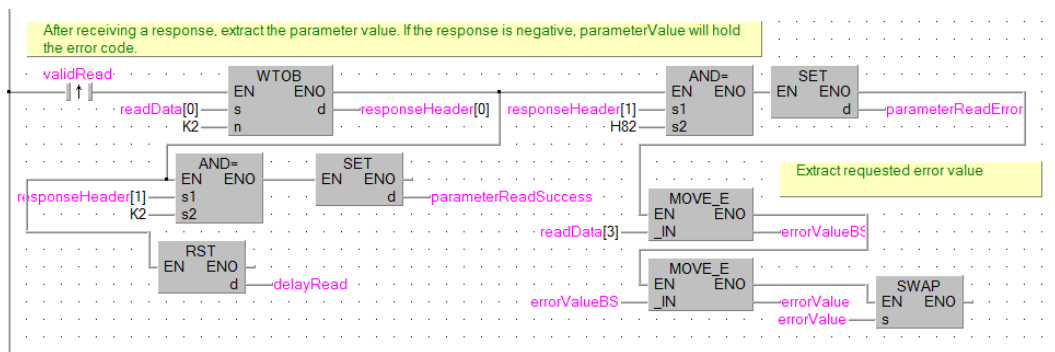

Executing example requests

To perform a parameter write, set the PNU of the parameter that will be changed to *requestParameterNo*. Assuming this is inverter parameter 15 (Jog frequency), add the offset 5096 and write the result to this variable. Set variable *requestParameterValue* to the requested value. The value that will be set, will be the output of multiplication of the set value, and the minimum setting increments, as according to the parameter list in the inverter manual. For parameter 15, the minimum setting increment is 0.01Hz. If a jog frequency of 5Hz is to be set, set *requestParameterValue* to 500. Finally execute the request by setting bit *requestParameter* to ON. A successful write will result in setting of the *parameterWriteSuccess* bit.

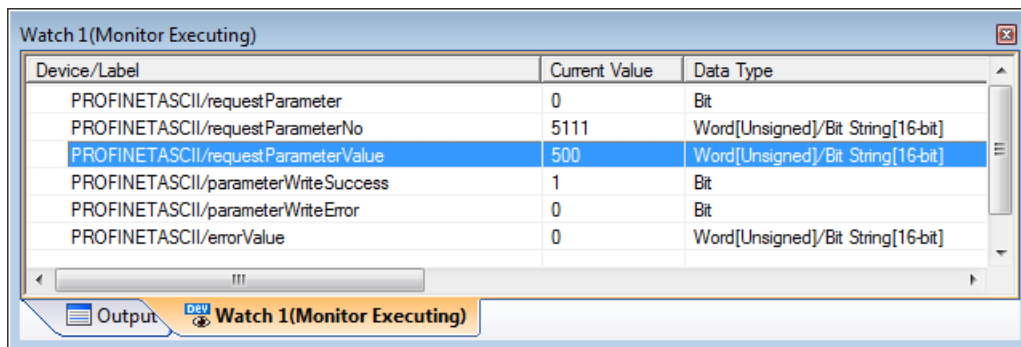

Device/Label	Current Value	Data Type
PROFINETASCII/requestParameter	0	Bit
PROFINETASCII/requestParameterNo	5111	Word[Unsigned]/Bit String[16-bit]
PROFINETASCII/requestParameterValue	500	Word[Unsigned]/Bit String[16-bit]
PROFINETASCII/parameterWriteSuccess	1	Bit
PROFINETASCII/parameterWriteError	0	Bit
PROFINETASCII/errorValue	0	Word[Unsigned]/Bit String[16-bit]

Test receiving a negative response, by trying to write an out of range value. After trying to write 0xFFFF as the value of parameter 15, a negative response is received with error code 0x02 (LOW_OR_HIGH_LIMIT_EXCEEDED), which is the expected behavior.

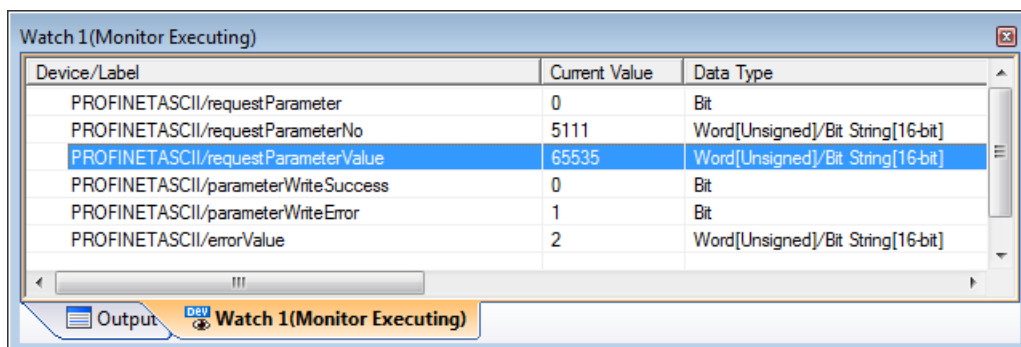

Device/Label	Current Value	Data Type
PROFINETASCII/requestParameter	0	Bit
PROFINETASCII/requestParameterNo	5111	Word[Unsigned]/Bit String[16-bit]
PROFINETASCII/requestParameterValue	65535	Word[Unsigned]/Bit String[16-bit]
PROFINETASCII/parameterWriteSuccess	0	Bit
PROFINETASCII/parameterWriteError	1	Bit
PROFINETASCII/errorValue	2	Word[Unsigned]/Bit String[16-bit]

3.9 GX Works Network Detect

The *Net_Detect* function block provided with the library generated by GX Configurator PN can be used to detect devices on the PROFINET network. In chapter Profinet Controller setup using CC-CPU, it is only necessary to create a new configuration, download it to the C Controller and update the GX Works 2 Project (there is no need to setup any PROFINET devices). Basing this chapter on the GX Works 2 project created in chapter Preparing the GX Works Project, makes it possible to detect the A8NPRT-2P option card, as well as any other PROFINET IO devices on the network. For this example, extended information about the PROFINET devices will not be requested. Information on how to do this is supplied with the PROFINET controller manual.

Create a new ladder block, that will be responsible for creating the network detect request.

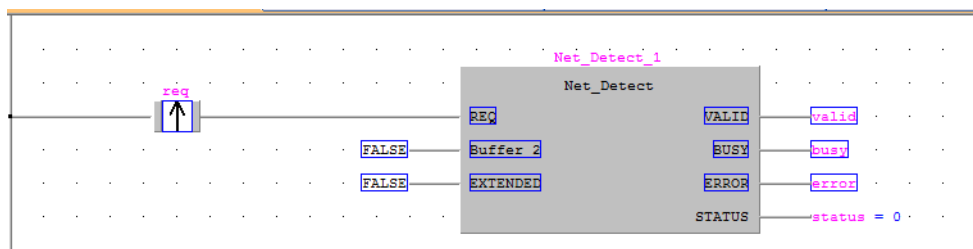

Compile and download the project to the PLC. Turning on the *req* bit will trigger the network detect. After the *BUSY* output turns off, the *VALID* output variable is ON for one scan, and it is possible to read the state of the network in output *STATUS*, and an array of detected PROFINET devices in global variable *ProfinetDetect* (if the naming convention from chapter Preparing the GX Works Project was used). The *STATUS* word is described below:

Value	Description
0	Status OK
1	Profinet stack not started
4	Reception buffer too small (stack internal error)
5	No more IO-device
6	"Network detection" service never called

An example execution result is presented below:

Device/Label	Current Value	Data Type	Class	Device	Address	Comment
PROFINET_IO_ME1PN1FW_Q/req	1	Bit	VAR	M8183	%MX0.8183	
ProfinetDetect		tPN_DEVICE_DETECT_DATA [1]	VAR_GLOB...			
[1]		tPN_DEVICE_DETECT_DATA				
VendorID	268	Word[Unsigned]/Bit String[16-bit]		D12277	%MW0.12277	
DeviceID	2050	Word[Unsigned]/Bit String[16-bit]		D12278	%MW0.12278	
IP_Address	3232236305	Double Word[Unsigned]/Bit String[32-bit]		D12279	%MD0.12279	
Subnetmask	4294967040	Double Word[Unsigned]/Bit String[32-bit]		D12281	%MD0.12281	
Gateway	0	Double Word[Unsigned]/Bit String[32-bit]		D12283	%MD0.12283	
MAC_Address_Bytes1_2	12288	Word[Unsigned]/Bit String[16-bit]		D12285	%MW0.12285	
MAC_Address_Bytes3_4	2577	Word[Unsigned]/Bit String[16-bit]		D12286	%MW0.12286	
MAC_Address_Bytes5_6	64279	Word[Unsigned]/Bit String[16-bit]		D12287	%MW0.12287	
PROFINET_IO_ME1PN1FW_Q/stat...	0	Word[Unsigned]/Bit String[16-bit]	VAR	D12275	%MW0.12275	

3.10 TIA Portal Telegram 1 example

This chapter describes running the inverter through the A8PRT-2P Profinet option card using TIA Portal with telegram 1 communication.

- ① Start with a new project.

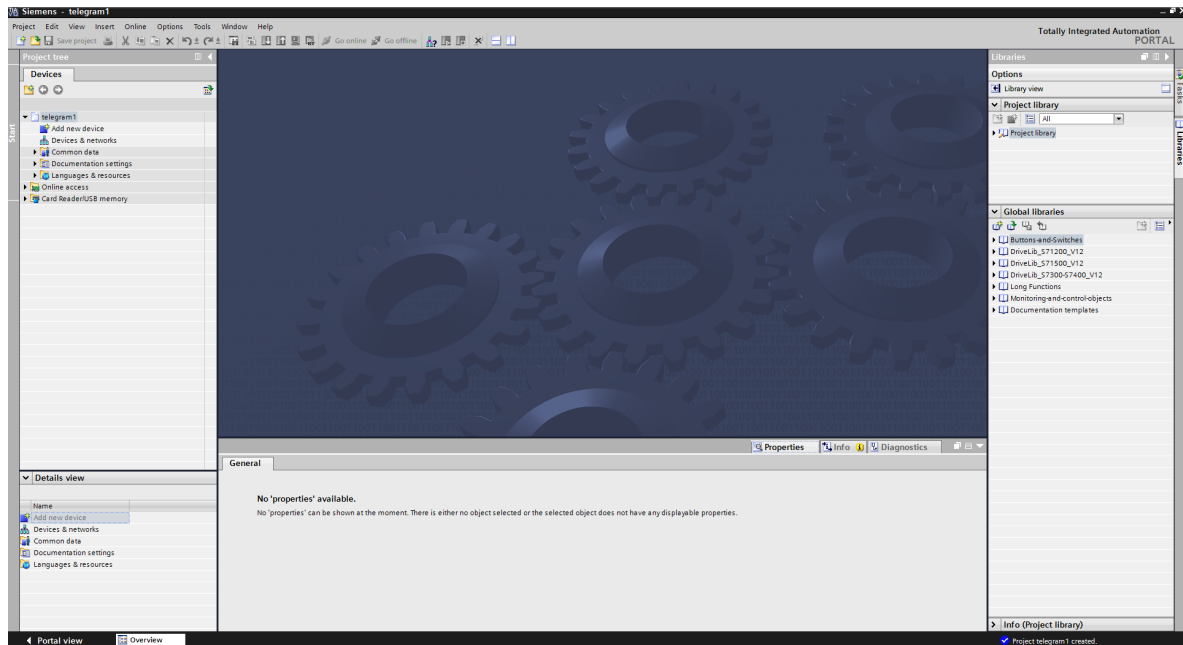

- ② Select Add new device from the Project tree section. In the new window select the appropriate PLC model and click OK to add it to the project. Select the power supply from the hardware catalog on the right side of the screen.

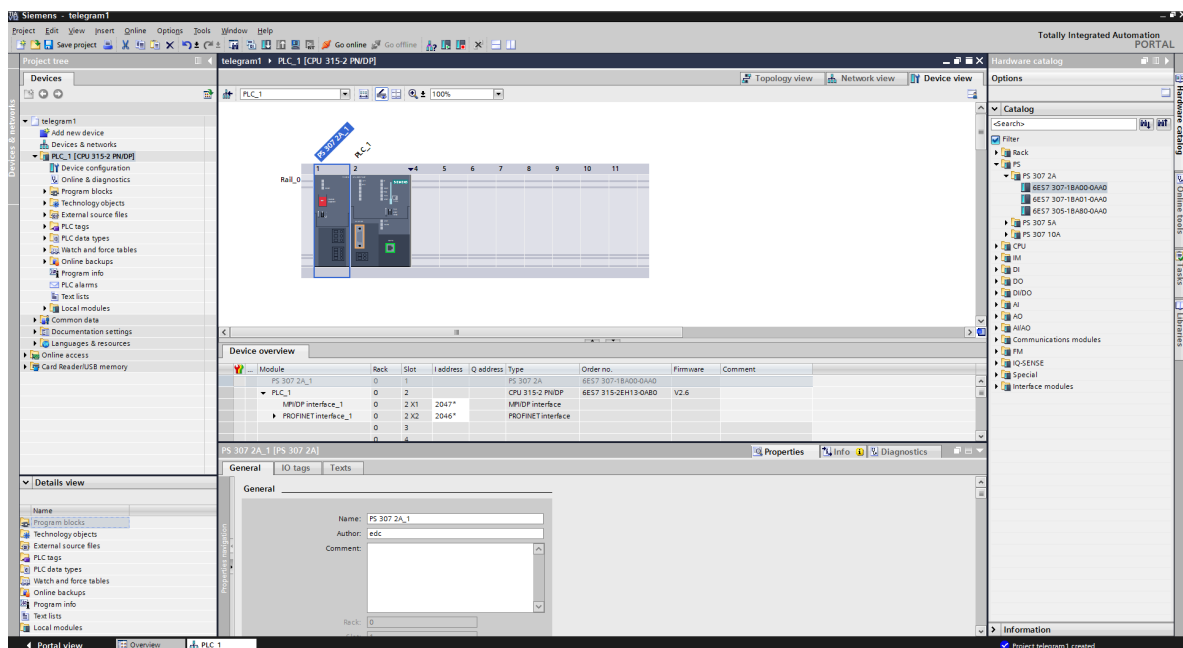

- ③ From the top menu select Options and Install general station description file (GSD). Search for the GSD file supplied with this manual, click Install and follow instructions to add the option card to the hardware library.

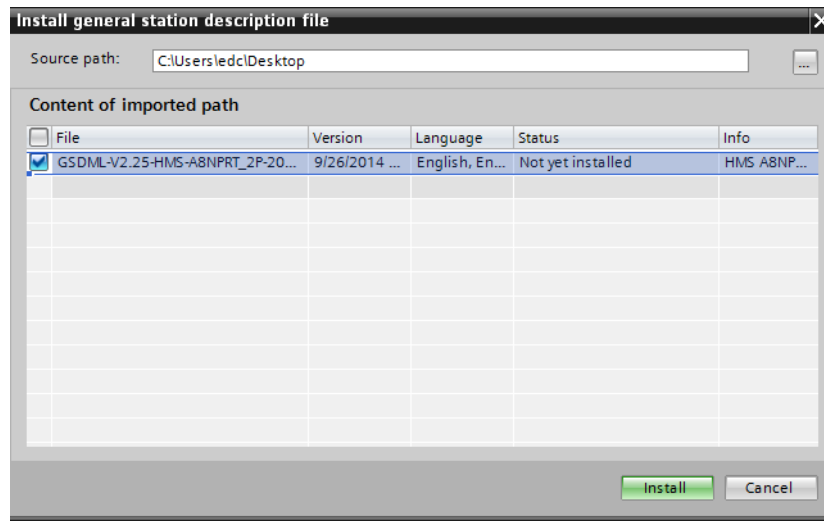

- ④ After finishing installation and returning to the main window, switch to Network view.

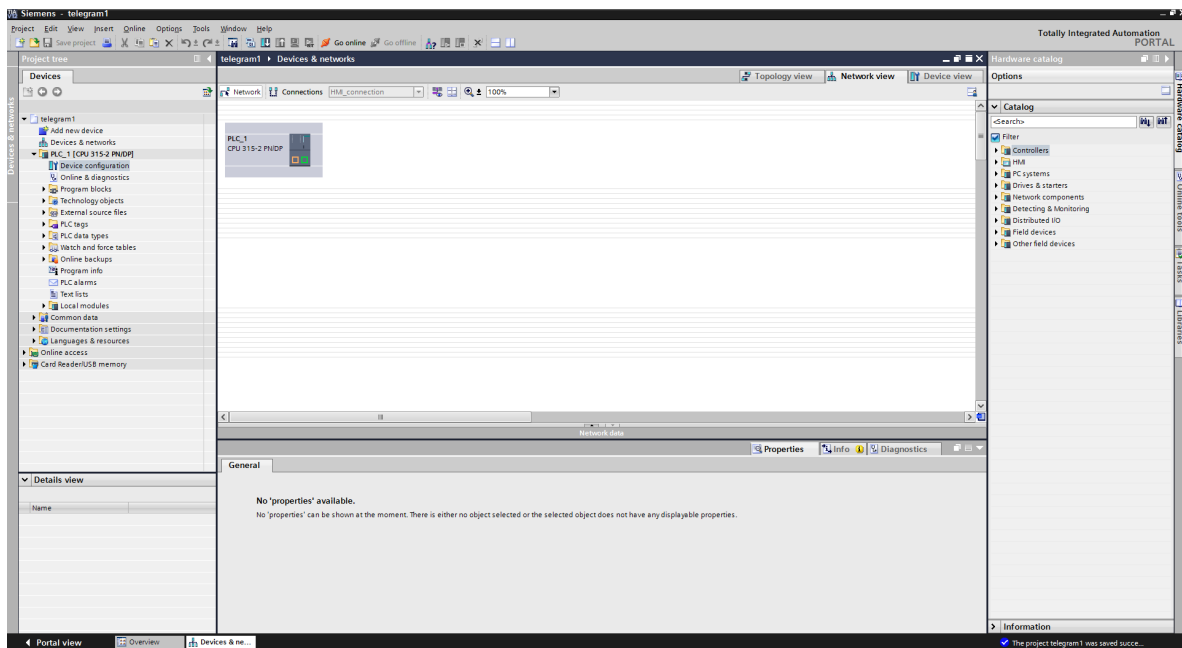

- ⑤ From the hardware catalog on the right side of the screen, expand Other field devices => Profinet IO => Drives => HMS Industrial Networks => A8PRT-2P and add RT to the project by dragging it to an empty space.

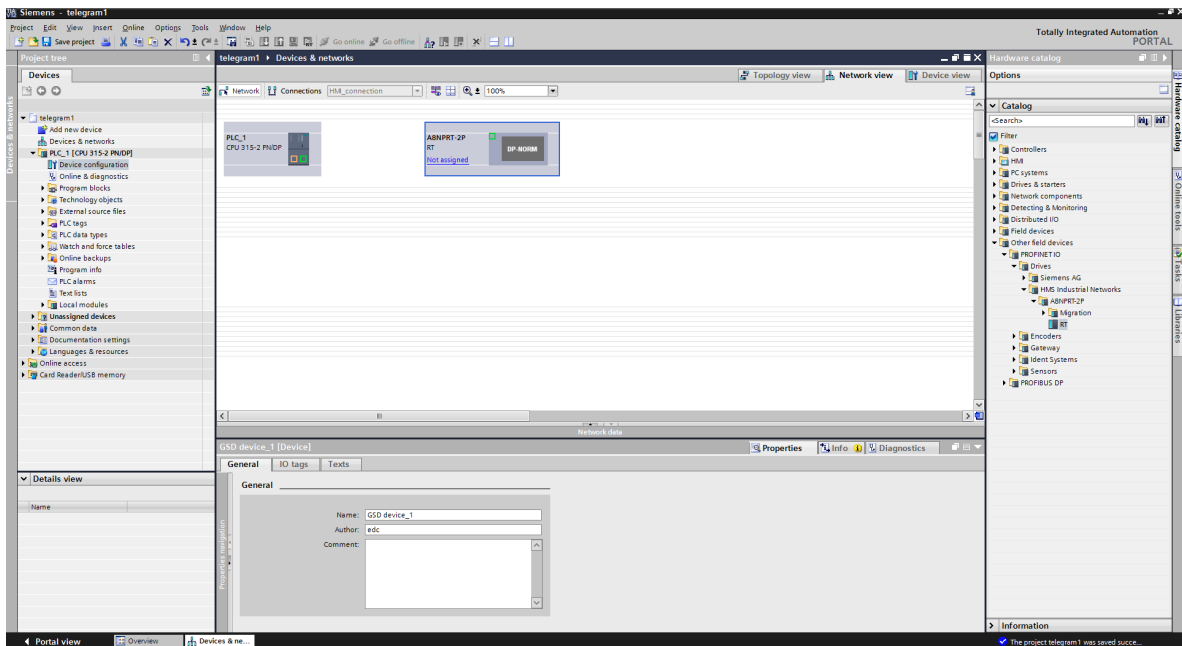

- ⑥ Drag a line from the slave connection node to the PLC connection node to make the PROFINET connection.

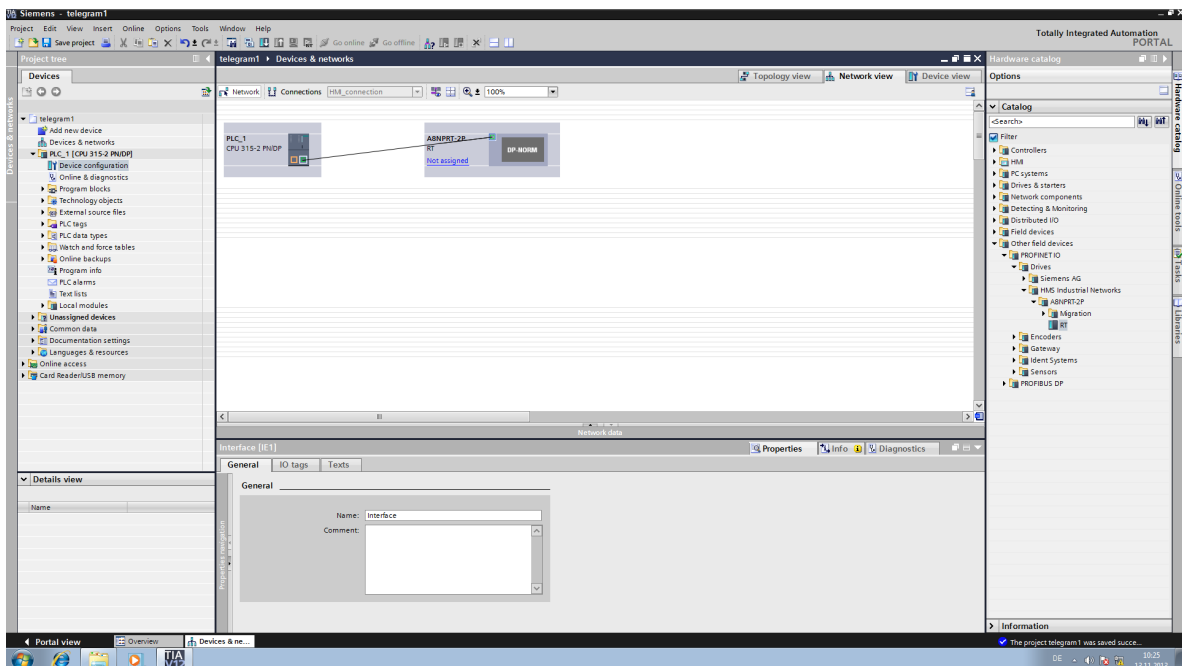

The result should look like on the screenshot below:

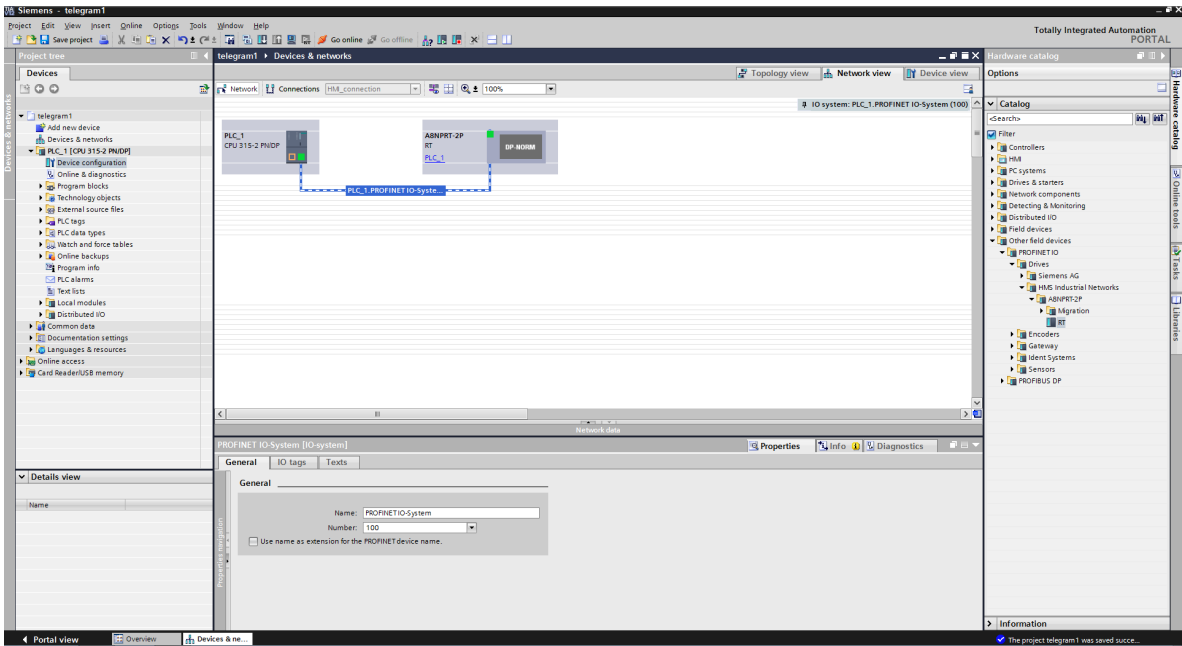

- ⑦ Double click on A8NPRT-2P from the device overview to bring up the Properties panel. From the hardware catalog expand Telegrams and drag Telegram 1 to the available slot.

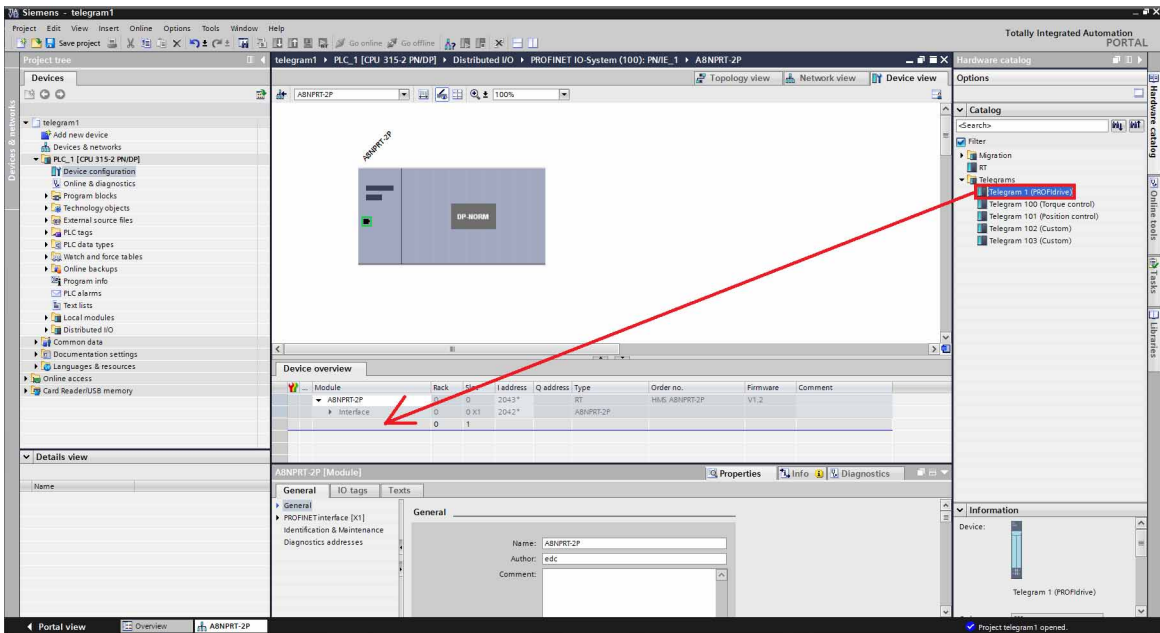

- ⑧ Change the I address for Module Access Point to start at 0, and the I and Q address for Standard Telegram 1 to start at 1. The result should look like below:

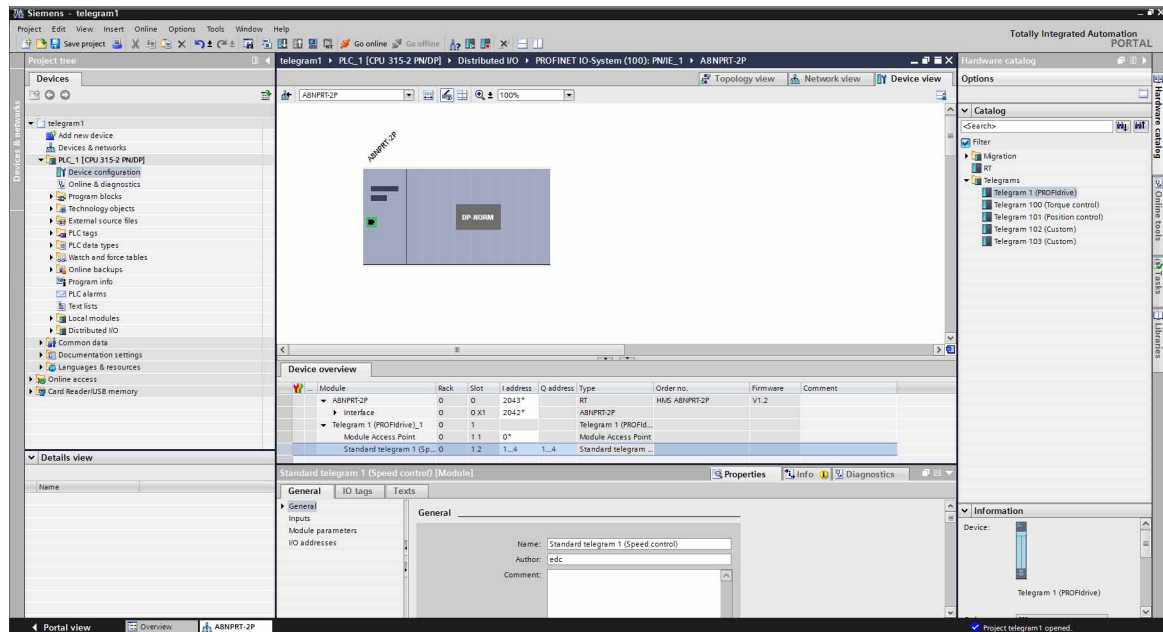

- ⑨ Double click on the PROFINET device to show the properties tab. Enter the PROFINET interface [X1] node. Scroll down to the Ethernet addresses section. Make sure the appropriate subnet is selected, enter the IP address of the A8NPRT-2P option card (192.168.3.17). In the PROFINET section, enter the device name (a800inverter) and the device number (17).

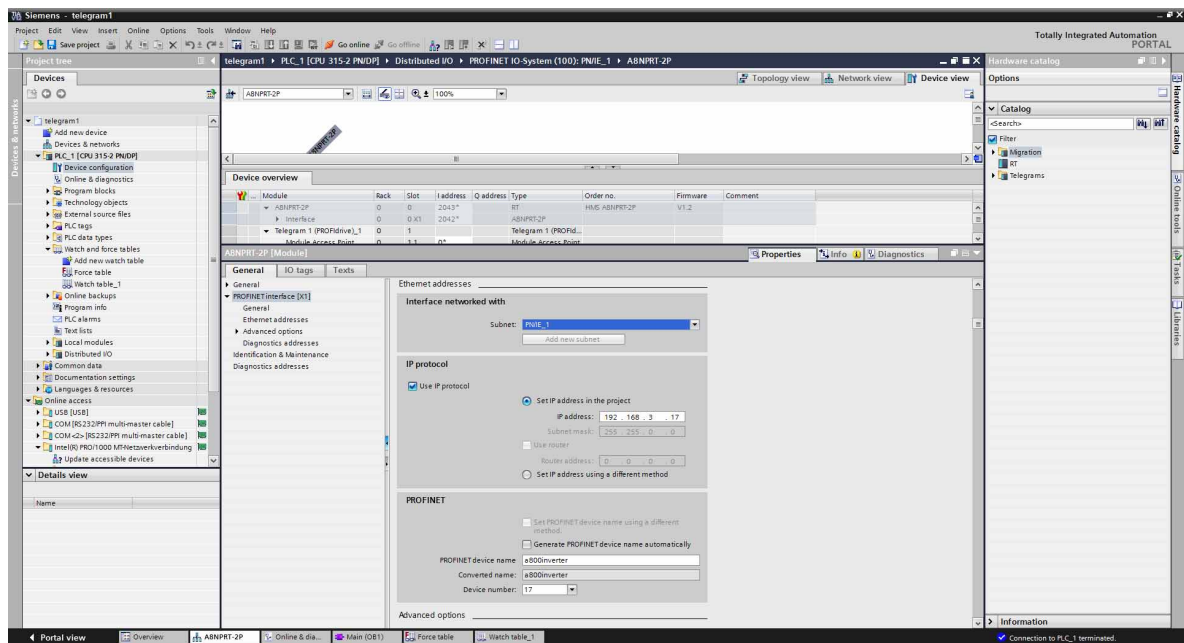

- ⑩ Return to device view, and click on the PLC. In the Properties tab, expand the PROFINET node, and add the IP address of the PROFINET controller. For this example use address 192.168.3.10.

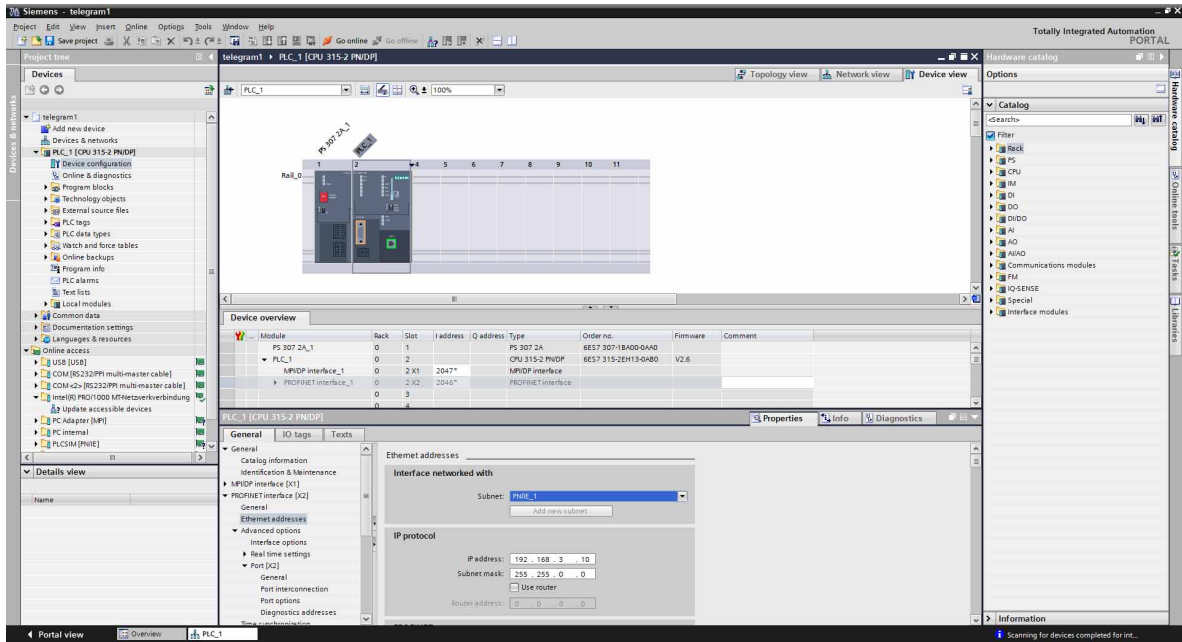

- ⑪ From the project tree select Program blocks and double click on Main to start editing the program. With this setup STW1 is available under QW1, NSOLL_A under QW3, ZSW1 under IW1, and NIST_A under IW3.

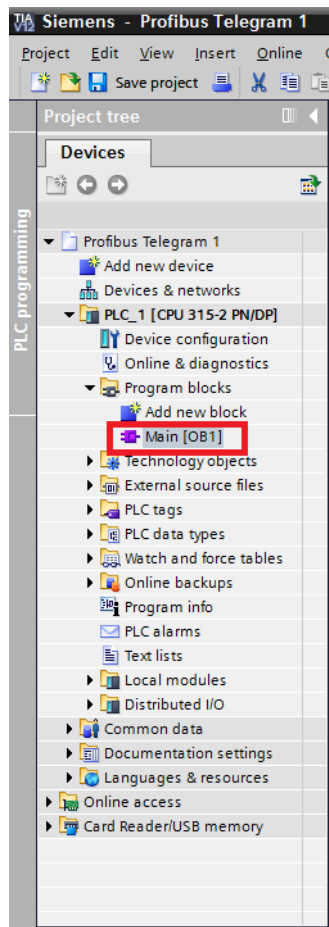

- ⑫ After powering up the inverter and PROFINET controller, connection will be established. Expect to see bit 6 (Switching On inhibited) set in ZSW1. Below is a simplified state diagram, dependent on control word 1 (STW1).

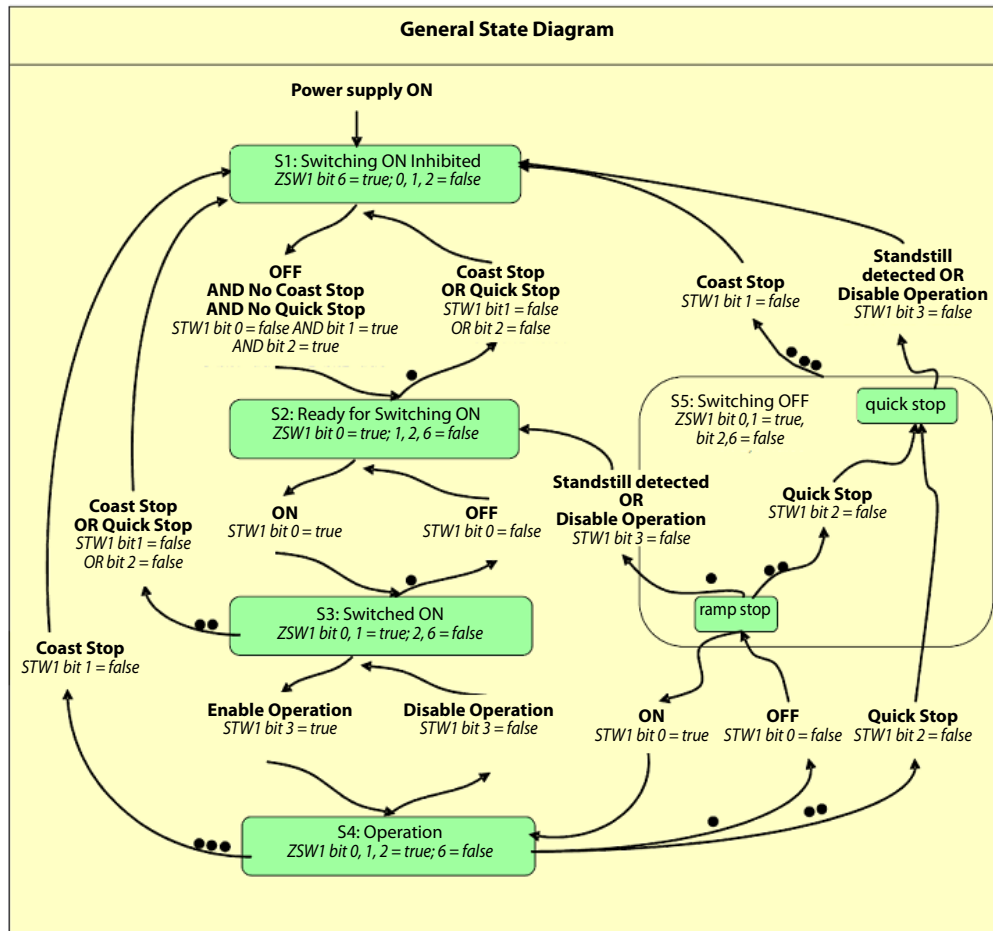

Control Word 1 (STW1) description

State / Bit combination	Bit 10	Bit 7	Bit 3	Bit 2	Bit 1	Bit 0
Description	Control By PLC	Fault acknowledge	Enable operation	No quick stop	No coast stop	On
Switching On Inhibited	-	-	-	-	0	-
Ready To Switch On	-	-	-	0	-	-
Switched On	-	-	-	1	1	1
Operation	-	-	1	1	1	1
Rotation	1	-	1	1	1	1
Fault reset	-	0 => 1	-	-	-	-

Both No Coast Stop and No Quick Stop need to be set to reset the Switching On Inhibited bit in ZSW1. To do this, set bits 1 and 2 in STW1, that is bit 1 and 2 in QW1.

Input the following ladder block to allow the inverter to enter “Ready For Switching On” status, after connection is established, and initialization command is given (M0.0).

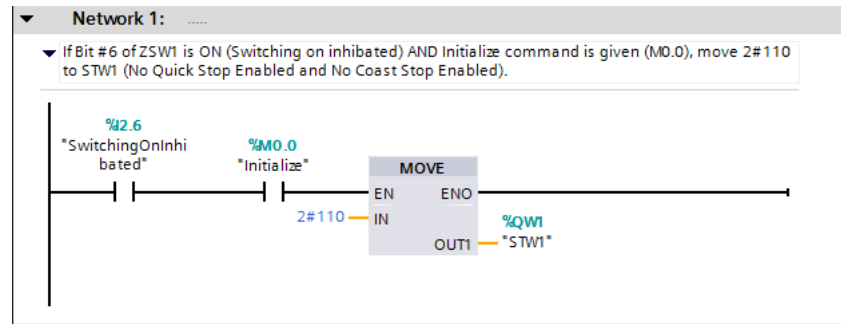

- ⑬ This initialization will result in setting bit 0 in ZSW1 (Ready To Switch On). We can now switch on the inverter, and start operation. To do this, enable bits 0 (ON/Off), 3 (enable operation), and 10 (Control By PLC); while leaving bits 1 and 2 enabled.

In the same ladder block, set the desired rotation frequency. Assuming the motor is rated for 50 Hz (inverter parameter 3) and a frequency of 10 Hz is the target run frequency (20% of the rated motor speed); the value in Profidrive to allow full power is 16384, so in order to set 20% of the rated motor speed as the run frequency, set value 3277 to the NSOLL_A (QW3) output (3276,8 round to 3277).

Add the following ladder block to enable rotation command after initialization, and giving rotation command (M0.1).

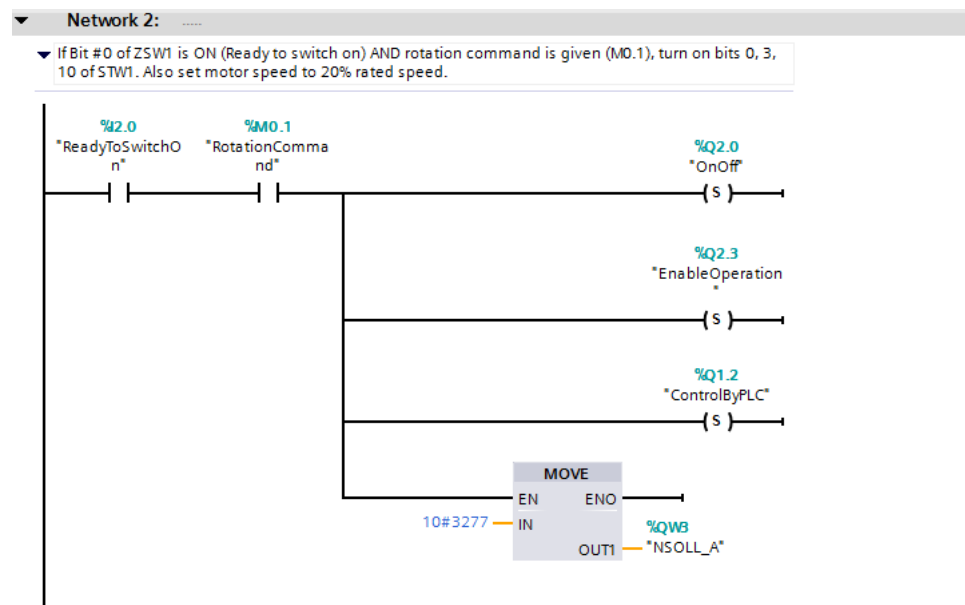

- ⑭ Finally, add the code to stop the drive, when M0.1 is reset. In a new ladder block, check whether the first 3 bits of ZSW1 are ON. This condition means that the drive is in operation mode. If this condition is met, and M1 is not ON, reset the set point speed to zero, and set STW1 as 6.

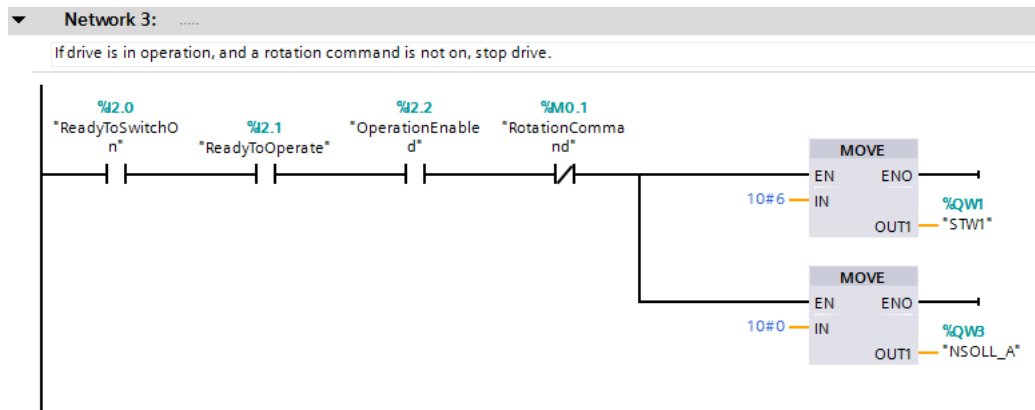

- ⑮ Compile, and write the program and parameters to the PLC. After resetting the PLC, and powering up the inverter, set bits M0.0 and M0.1 to get the inverter up and running.

telegram1 > PLC_1 [CPU 315-2 PN/DP] > Watch and force tables > Watch table_1

	Name	Address	Display format	Monitor value	Modify value		Comr
1	"Initialize"	%M0.0	Bool	TRUE	TRUE	<input checked="" type="checkbox"/>	<input checked="" type="checkbox"/>
2	"RotationCom..."	%M0.1	Bool	TRUE	TRUE	<input checked="" type="checkbox"/>	<input checked="" type="checkbox"/>
3		%IW1	DEC	33591		<input type="checkbox"/>	<input type="checkbox"/>
4	"STW1"	%QW1	DEC	1039		<input type="checkbox"/>	<input type="checkbox"/>
5	"NSOLL_A"	%QWB	DEC	3277		<input type="checkbox"/>	<input type="checkbox"/>
6		<Add new>				<input type="checkbox"/>	<input type="checkbox"/>

3.11 TIA Portal Telegram 102 example

This chapter describes running the inverter through the A8NPRT-2P PROFINET option card using Siemens TIA with telegram 102 (custom) communication. First perform the setup using telegram 1.

- 1 Enter the device view of the PROFINET option card and delete Standard Telegram 1 from the device overview.

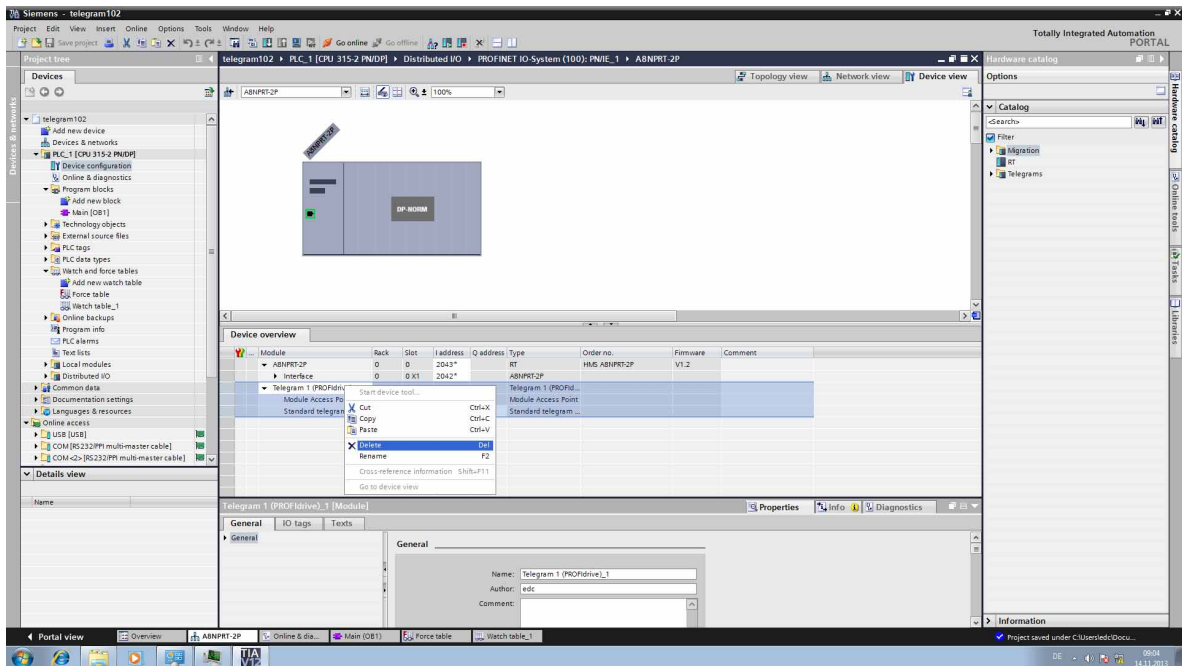

- 2 Now drag Telegram 102 (Custom) from the Hardware Catalog to the empty slot. Change the starting I and Q address of Telegram 102 to 1, and the starting I address of the Module Access Point to 0.

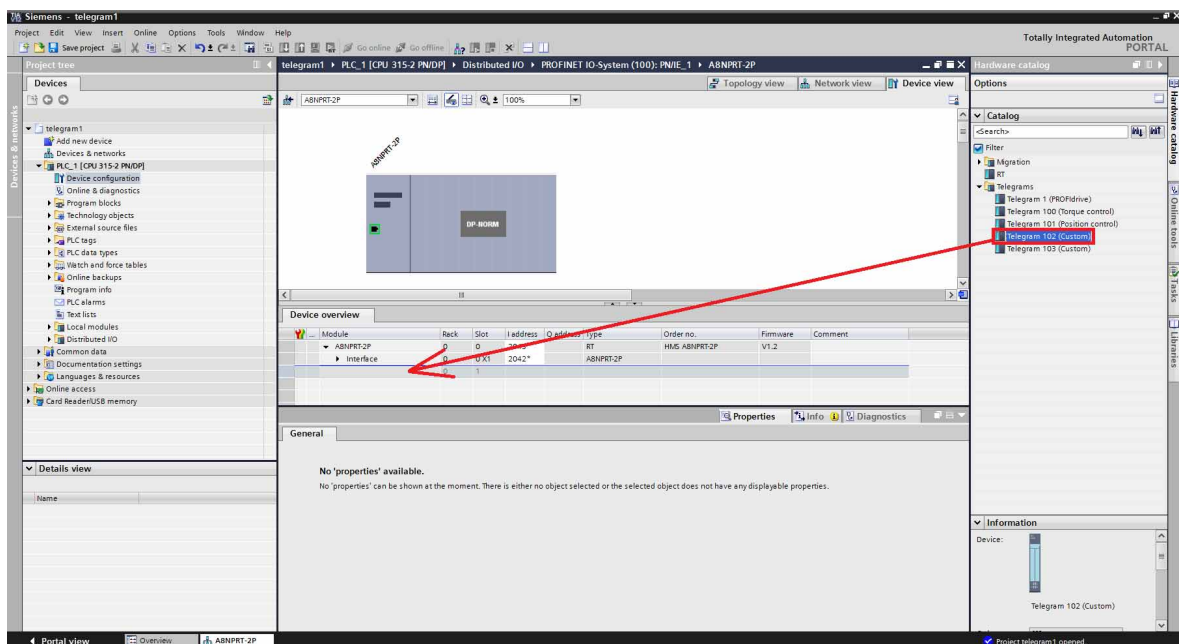

- ③ After double clicking on the telegram and selecting Module parameters node from the properties tab, it is possible to setup the input and outputs of the telegram. There are 18 inputs and outputs used in this telegram, one of each is reserved for control/status word (leaving 17 inputs/outputs free for custom setup).

The setup of the telegram is done by entering signal/parameter numbers into the right column. All monitor data can be viewed as input, and some of the profile parameters as input/output. Please keep in mind, that not all parameters can be accessed via cyclic communication. The PROFIdrive parameter numbers (PNUs) available for use are listed in the Data Exchange subchapters 9.1 to 9.4. An example setup is provided below:

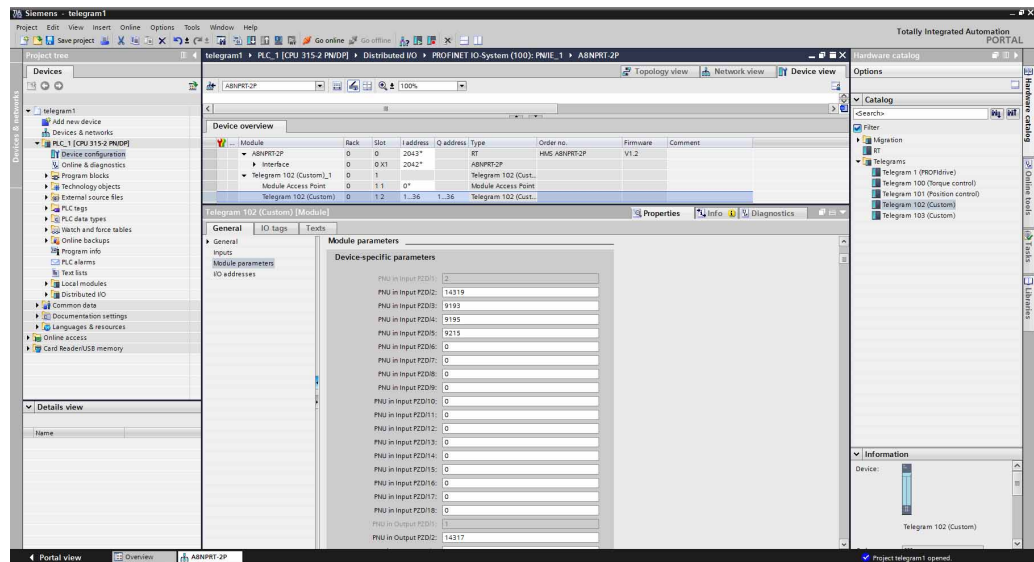

Slot	Description	PNU
Output PZD/2	Speed set point	14317
Input PZD/2	Actual speed set point	14319
Input PZD/3	Output frequency	9193
Input PZD/4	Output voltage	9195
Input PZD/5	Actual operation time	9215

- ④ Compile the project and download it to the PLC. The additional monitor data can be viewed in the appropriate IW address.

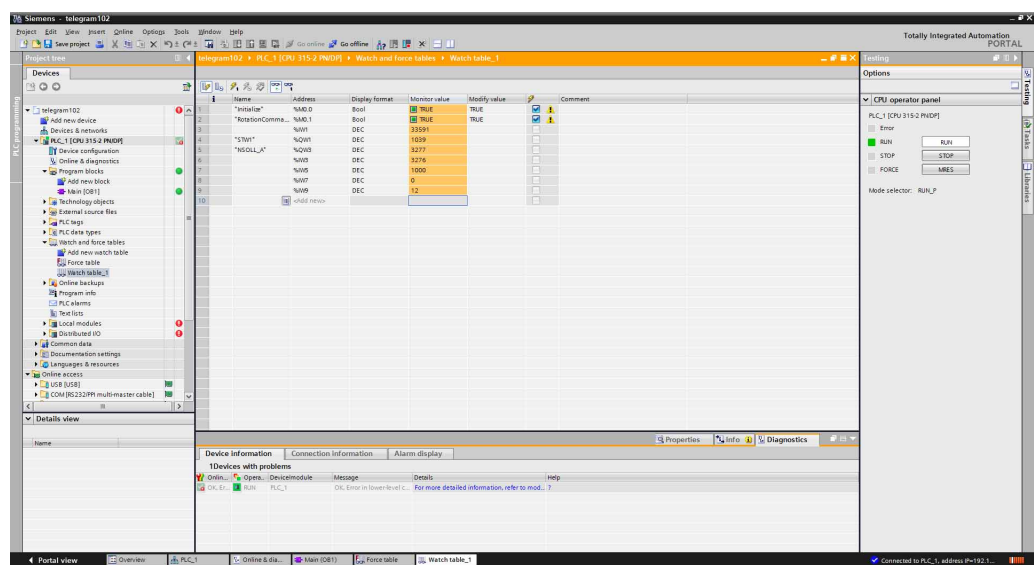

3.12 TIA Portal Acyclic communication example

This chapter describes using acyclic communication through the A8NPRT-2P PROFINET option card using TIA Portal. It contains examples of reading and writing individual parameters. First perform the setup using telegram 1.

The process of acyclic communication parameter read consists of a write request, and a response read, performed using instructions *WRREC* and *RDREC*.

3.12.1 Reading a parameter (Sequence 1)

Preparing structure of write request, and read response

Start by preparing the structure for the write request. The data request has the following format:

Byte no.	Description	Value
0	Request ID	0x01
1	Request reference	0x01-0xFF
2	No. of parameters	0x01
3	DO-ID	0x01
4	No. of elements	0x00
5	Attribute value	0x10 (value attribute)
6-7	Parameter number	Byte swapped PNU

Request reference is any valid number, this value is mirrored back in the response and can be used to distinguish multiple requests. Once this request is processed successfully, a read request can be issued. The response of this request will contain the actual parameter value. The format of a positive response is as follows:

Byte no.	Description	Value
0	Request ID	0x01
1	Request reference	0x01-0xFF (same as in request)
2	No. of parameters	0x01
3	DO-ID	0x01
4	No. of values	0x01
5	Format	See data format type table
6-7	Parameter value	Byte swapped parameter value

In case of a negative response, the format is:

Byte no.	Description	Value
0	Request ID	0x81
1	Request reference	0x01-0xFF (same as in request)
2	No. of parameters	0x01
3	DO-ID	0x01
4	No. of values	0x01
5	Format	0x44 (error)
6-7	Error value	Byte swapped error value (see error table)

The content of the data request will be contained in a data block structure. Expand the PLC in the project tree and add a new block.

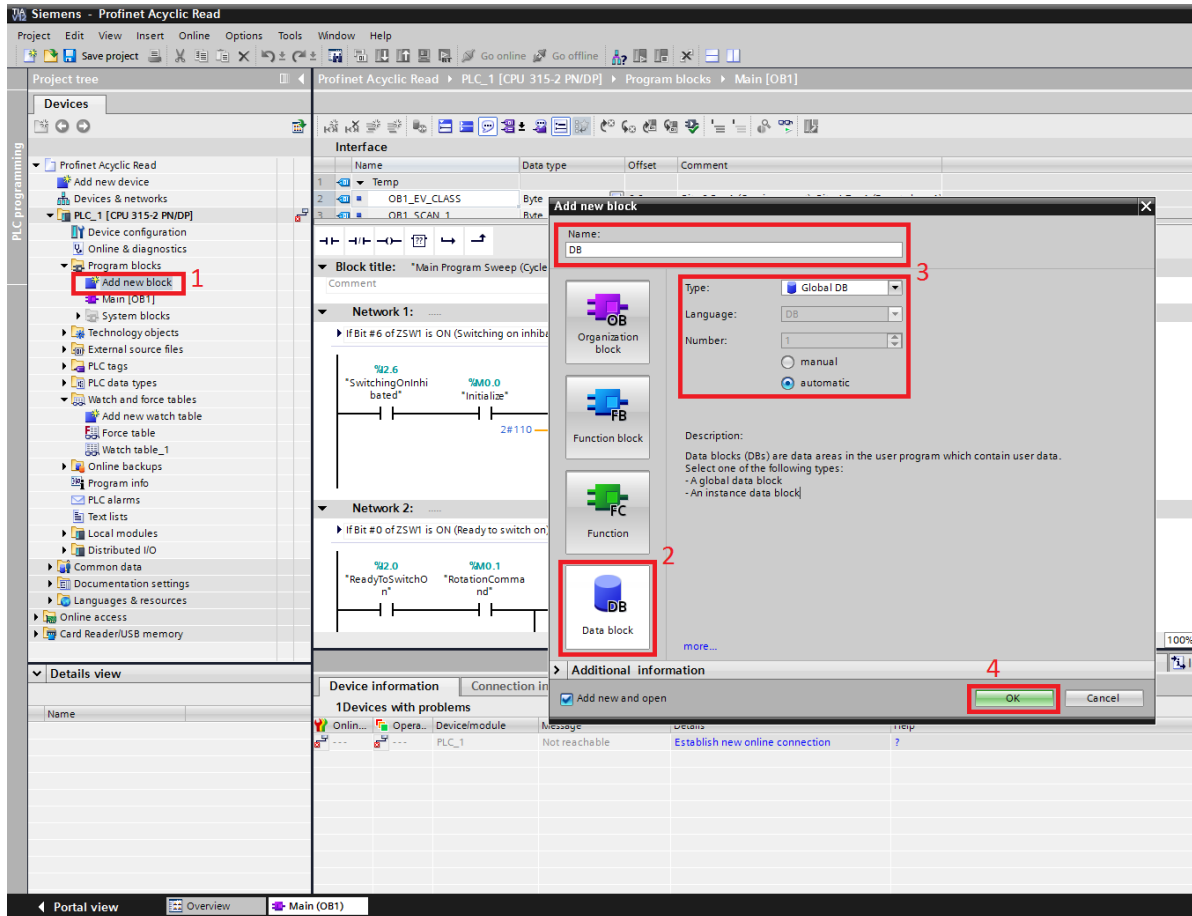

The data block will be added to the program blocks with the specified name. Add two structures (*RequestRecord* and *ResponseRecord*) to the data block. Create the structure of the records according to the specification, like on the screenshot below. Enter the start value for the variables so that the fields don't need to be initialized in the user program.

	Name	Data type	Offset	Start value	Retain	Visible in ...	Setpoint
1	Static				<input type="checkbox"/>	<input type="checkbox"/>	<input type="checkbox"/>
2	RequestRecord	Struct	0.0		<input checked="" type="checkbox"/>	<input checked="" type="checkbox"/>	<input type="checkbox"/>
3	ReferenceID	Byte	0.0	01	<input checked="" type="checkbox"/>	<input checked="" type="checkbox"/>	<input type="checkbox"/>
4	RequestID	Byte	1.0	01	<input checked="" type="checkbox"/>	<input checked="" type="checkbox"/>	<input type="checkbox"/>
5	Axis	Byte	2.0	1	<input checked="" type="checkbox"/>	<input checked="" type="checkbox"/>	<input type="checkbox"/>
6	NoOfParameters	Byte	3.0	1	<input checked="" type="checkbox"/>	<input checked="" type="checkbox"/>	<input type="checkbox"/>
7	Attribute	Byte	4.0	16#10	<input checked="" type="checkbox"/>	<input checked="" type="checkbox"/>	<input type="checkbox"/>
8	NoOfIndices	Byte	5.0	1	<input checked="" type="checkbox"/>	<input checked="" type="checkbox"/>	<input type="checkbox"/>
9	PNU	Int	6.0	5097	<input checked="" type="checkbox"/>	<input checked="" type="checkbox"/>	<input type="checkbox"/>
10	Index	Int	8.0	0	<input checked="" type="checkbox"/>	<input checked="" type="checkbox"/>	<input type="checkbox"/>
11	ResponseRecord	Struct	10.0		<input checked="" type="checkbox"/>	<input checked="" type="checkbox"/>	<input type="checkbox"/>
12	ReferenceID	Byte	0.0	16#0	<input checked="" type="checkbox"/>	<input checked="" type="checkbox"/>	<input type="checkbox"/>
13	ResponseID	Byte	1.0	16#0	<input checked="" type="checkbox"/>	<input checked="" type="checkbox"/>	<input type="checkbox"/>
14	Axis	Byte	2.0	16#0	<input checked="" type="checkbox"/>	<input checked="" type="checkbox"/>	<input type="checkbox"/>
15	NoOfParameters	Byte	3.0	16#0	<input checked="" type="checkbox"/>	<input checked="" type="checkbox"/>	<input type="checkbox"/>
16	Format	Byte	4.0	16#0	<input checked="" type="checkbox"/>	<input checked="" type="checkbox"/>	<input type="checkbox"/>
17	NoOfValues	Byte	5.0	16#0	<input checked="" type="checkbox"/>	<input checked="" type="checkbox"/>	<input type="checkbox"/>
18	Value	Int	6.0	0	<input checked="" type="checkbox"/>	<input checked="" type="checkbox"/>	<input type="checkbox"/>
19	ErrorDetails	Int	8.0	0	<input checked="" type="checkbox"/>	<input checked="" type="checkbox"/>	<input type="checkbox"/>

Creating the request

Proceed to create the user program for reading the parameter value. A state machine architecture is used for the process of creating, receiving and processing acyclic communication. The current state of the state machine is held in PLC tag *state*. A description of each state used in this example is provided below:

State	Description
1	Send write request, wait for BUSY = 0
2	Write request sent, read results
3	Write request sent successfully, send read request
4	Wait for BUSY = 0 (Read request)
5	Read request sent, read results
6	Results read
7	Successfully read requested PNU value
10	Write request error
11	Read request error
12	Parameter read error (negative response)

Start by adding a new network that will contain the instructions to issue the actual write and read requests.

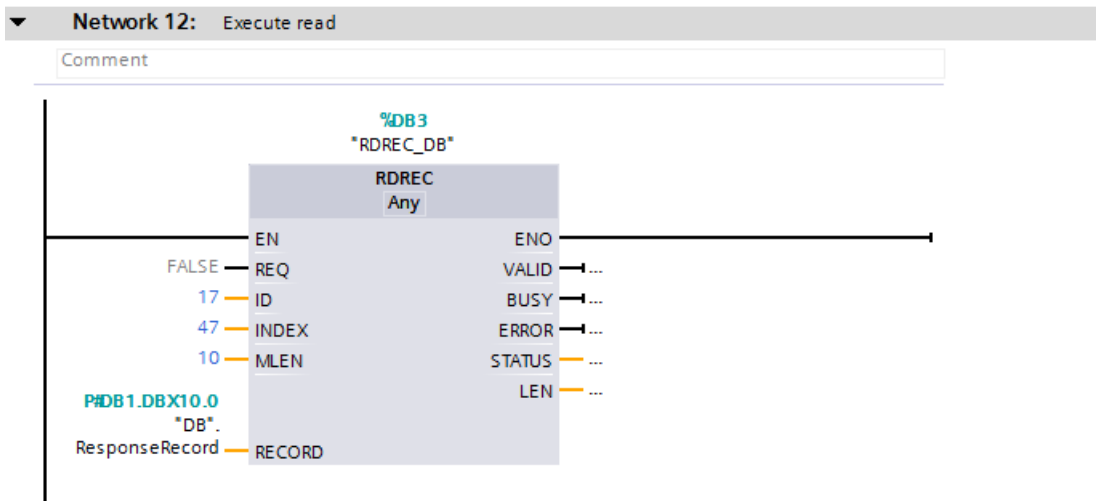
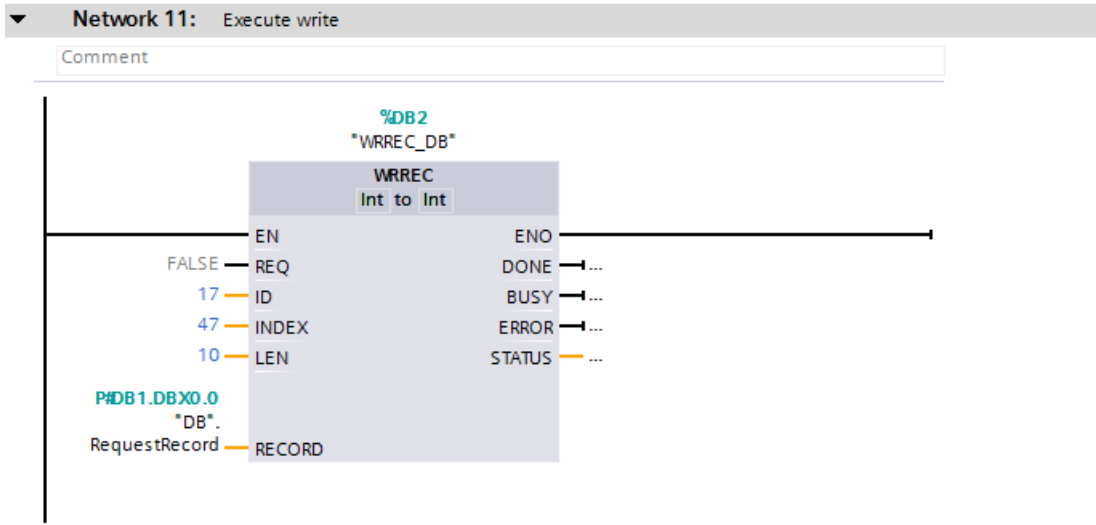

It will now be possible to reference the inputs and outputs of the function block instances, making it easier to create the program. Proceed to prepare the sequence. Add a new network in the user program that will start the state machine sequence. Setting *ParameterRequest* will start the state machine from state 1, initialize all used variables (*readStatus*, *readValue*, *writeStatus*), copy the requested PNU from tag *requestedPNU* to the data structure, and trigger the write request (by setting the *REQ* input of the *WRREC* function block).

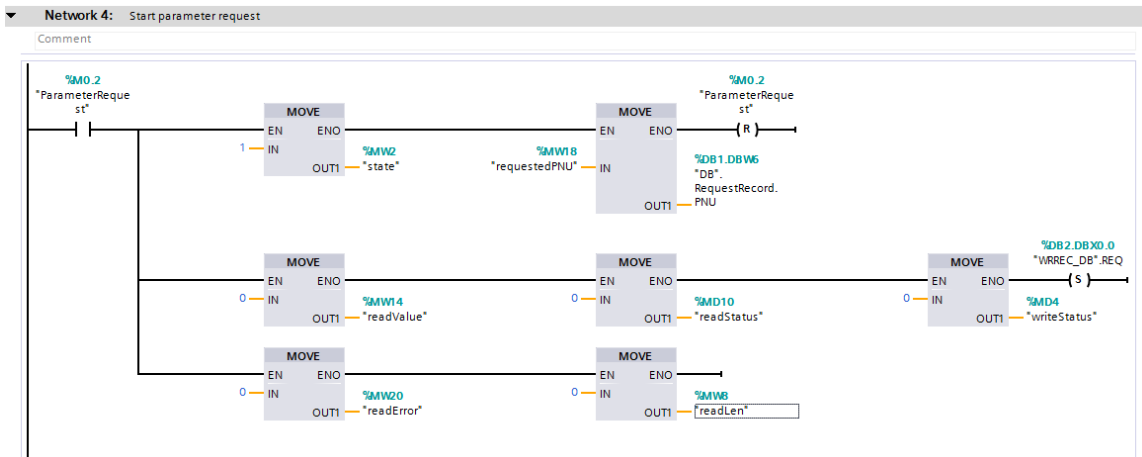

The *BUSY* output of *WRREC* will immediately turn ON. Once it turns OFF, proceed to reading the result of the write request (state 2).

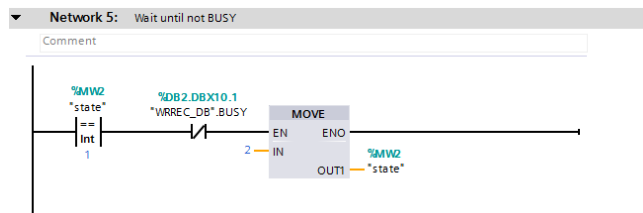

Expect to see either output *DONE* or *ERROR* of *WRREC* in an ON state. If *DONE* is ON, the write request was performed successfully, reset the *REQ* input, and proceed to creating the read request (state 3). If the *ERROR* output is ON, check the *STATUS* output to read the error. If the status is equal to 0xDE80B500, the result is not yet ready. In this case, do nothing and wait for the actual result. In every other case, save the status to tag *writeStatus* and enter state 10, indicating that a write request error occurred.

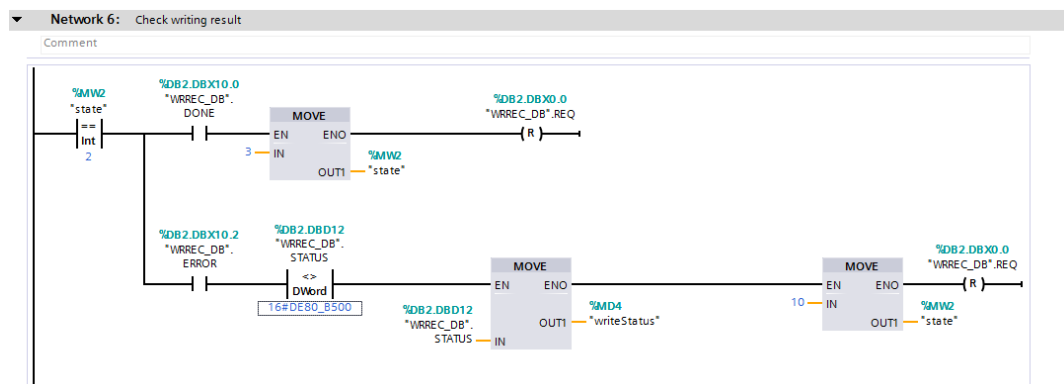

To initiate the read request, set input *REQ* of function block *RDREC*. Enter state 4, and wait for the *BUSY* output to turn off. Once this condition is met, enter state 5 to check the results of the read request.

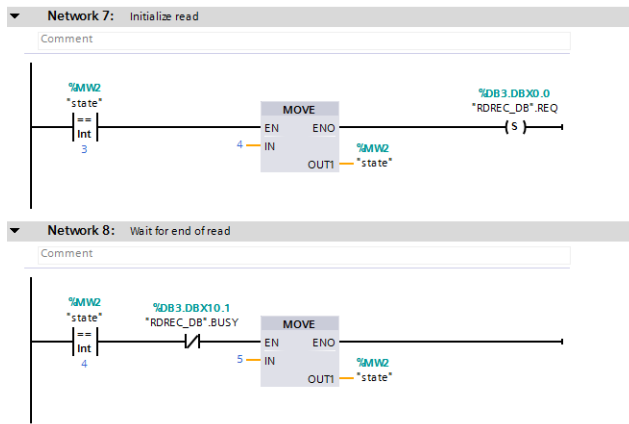

Expect to see either output *DONE* or *ERROR* of *RDREC* in an ON state. If *DONE* is ON, the read request was performed successfully, reset the *REQ* input, enter state 6 to process the response. If the *ERROR* output is ON, check the *STATUS* output to read the error. If the status is equal to 0xDF80B500, the result is not yet ready. In this case, do nothing and wait for the actual result. In every other case, save the status to tag *readStatus* and enter state 11, indicating that a read request error occurred.

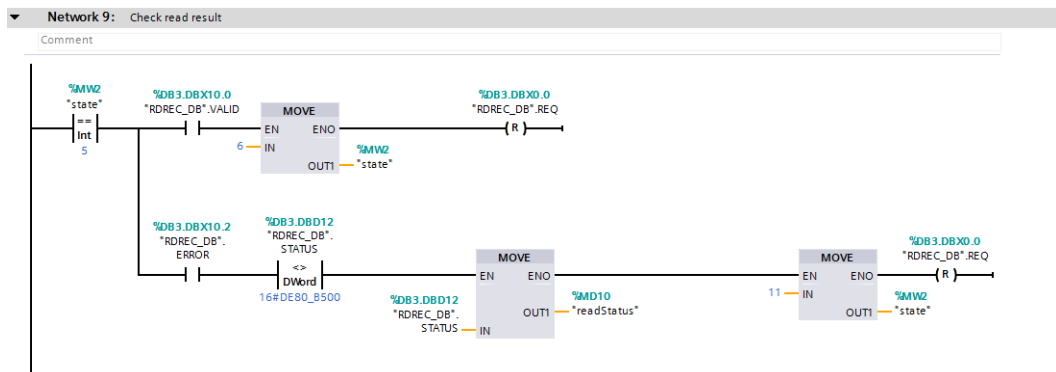

Finally process the received response. Check the *ResponseID* field of the *ResponseRecord*. A value of 1 indicates that the request was performed successfully. In this case move the *Value* field of this structure to the *readValue* tag. Enter state 7 to indicate a successful parameter read. If the *responseID* is equal to 0x81, then a negative response was received. Save the error value (also the *Value* field of the structure) to the *readError* tag. Enter state 12 to signal a negative response.

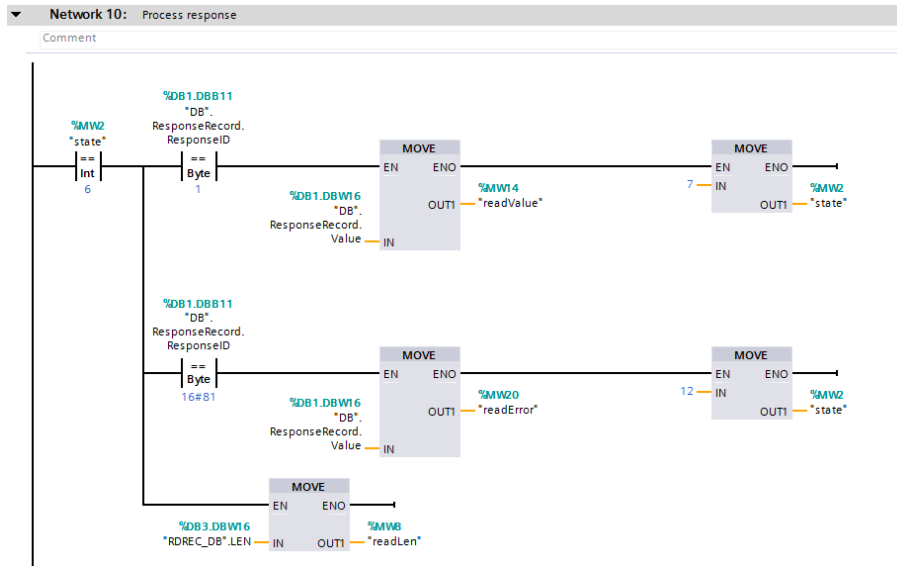

Executing example requests

After compiling the program, and writing it to the PLC, it is possible to execute parameter read requests. First, get the inverter running by setting bits M0 and M1. Now read the actual frequency by writing PNU 9193 to *requestPNU* and setting bit *ParameterRequest*. The result should be a value of 1000 in *readValue*, which corresponds to 10Hz.

Profinet Acyclic Read ▶ PLC_1 [CPU 315-2 PN/DP] ▶ Watch and force tables ▶ Watch table_1

	Name	Address	Display format	Monitor value	Modify value	
1	"Initialize"	%M0.0	Bool	<input checked="" type="checkbox"/> TRUE	TRUE	<input checked="" type="checkbox"/>
2	"RotationComma..."	%M0.1	Bool	<input checked="" type="checkbox"/> TRUE	TRUE	<input checked="" type="checkbox"/>
3	"state"	%MW2	DEC+/-	7	0	<input checked="" type="checkbox"/>
4	"requestedPNU"	%MW18	DEC+/-	9193	9193	<input checked="" type="checkbox"/>
5	"ParameterRequest"	%M0.2	Bool	<input type="checkbox"/> FALSE	TRUE	<input checked="" type="checkbox"/>
6	"writeStatus"	%MD4	Hex	16#0000_0000	16#0000_0000	<input type="checkbox"/>
7	"readStatus"	%MD10	Hex	16#0000_0000	16#0000_0000	<input type="checkbox"/>
8	"readValue"	%MW14	DEC+/-	1000		<input type="checkbox"/>
9	<Add new>					<input type="checkbox"/>

Try testing a negative response by changing the axis number to 0x10. Notice, that after executing the sequence, state 12 is active. An error code of 0x19 (AXIS_DO_NONEXISTENT) is expected.

Profinet Acyclic Read ▶ PLC_1 [CPU 315-2 PN/DP] ▶ Watch and force tables ▶ Watch table_1

	Name	Address	Display format	Monitor value	Modify value	
1	"Initialize"	%MO.0	Bool	<input checked="" type="checkbox"/> TRUE	TRUE	<input checked="" type="checkbox"/> ⚠
2	"RotationComma..."	%MO.1	Bool	<input checked="" type="checkbox"/> TRUE	TRUE	<input checked="" type="checkbox"/> ⚠
3	"state"	%MW2	DEC+/-	12	0	<input checked="" type="checkbox"/> ⚠
4	"requestedPNU"	%MW18	DEC+/-	6401	6401	<input checked="" type="checkbox"/> ⚠
5	"ParameterRequest"	%MO.2	Bool	<input type="checkbox"/> FALSE	TRUE	<input checked="" type="checkbox"/> ⚠
6	"writeStatus"	%MD4	Hex	16#0000_0000	16#0000_0000	<input type="checkbox"/>
7	"readStatus"	%MD10	Hex	16#0000_0000	16#0000_0000	<input type="checkbox"/>
8	"readValue"	%MW14	DEC+/-	0		<input type="checkbox"/>
9	"DB".RequestReco..	%DB1.DBB2	Hex	16#10	16#10	<input checked="" type="checkbox"/> ⚠
10	"readError"	%MW20	Hex	16#0019		<input type="checkbox"/>
11	<Add new>					<input type="checkbox"/>

3.12.2 Changing parameters (Sequence 2)

This example will be based off of the previous example (Reading a parameter – Sequence 1), as the changes needed are minimal.

Preparing structure of write request, and read response

Start by preparing the structure for the write request. The data request has the following format:

Byte no.	Description	Value
0	Request ID	0x02
1	Request reference	0x01-0xFF
2	No. of parameters	0x01
3	DO-ID	0x01
4	No. of elements	0x00
5	Attribute value	0x10 (value attribute)
6-7	Parameter number	PNU to modify
8-9	Subindex (irrelevant)	0x00
10	No. of values	0x01
11	Format	0x06 (UINT16 for all inverter parameters) See data format type table
12-13	Set value	PNU value to write

Once this request is processed successfully, a read request can be issued. The response of this request will determine whether the parameter write was successful. The format of a positive response is as follows:

Byte no.	Description	Value
0	Request ID	0x02
1	Request reference	0x01-0xFF (same as in request)
2	No. of parameters	0x01
3	DO-ID	0x01

In case of a negative response, the format is as follows:

Byte no.	Description	Value
0	Request ID	0x82
1	Request reference	0x01-0xFF (same as in request)
2	No. of parameters	0x01
3	DO-ID	0x01
4	No. of values	0x01
5	Format	0x44 (error)
6-7	Error value	Error value (see error table)

Modify the data structures created in the previous example to account for the changes (note the changes in start value fields):

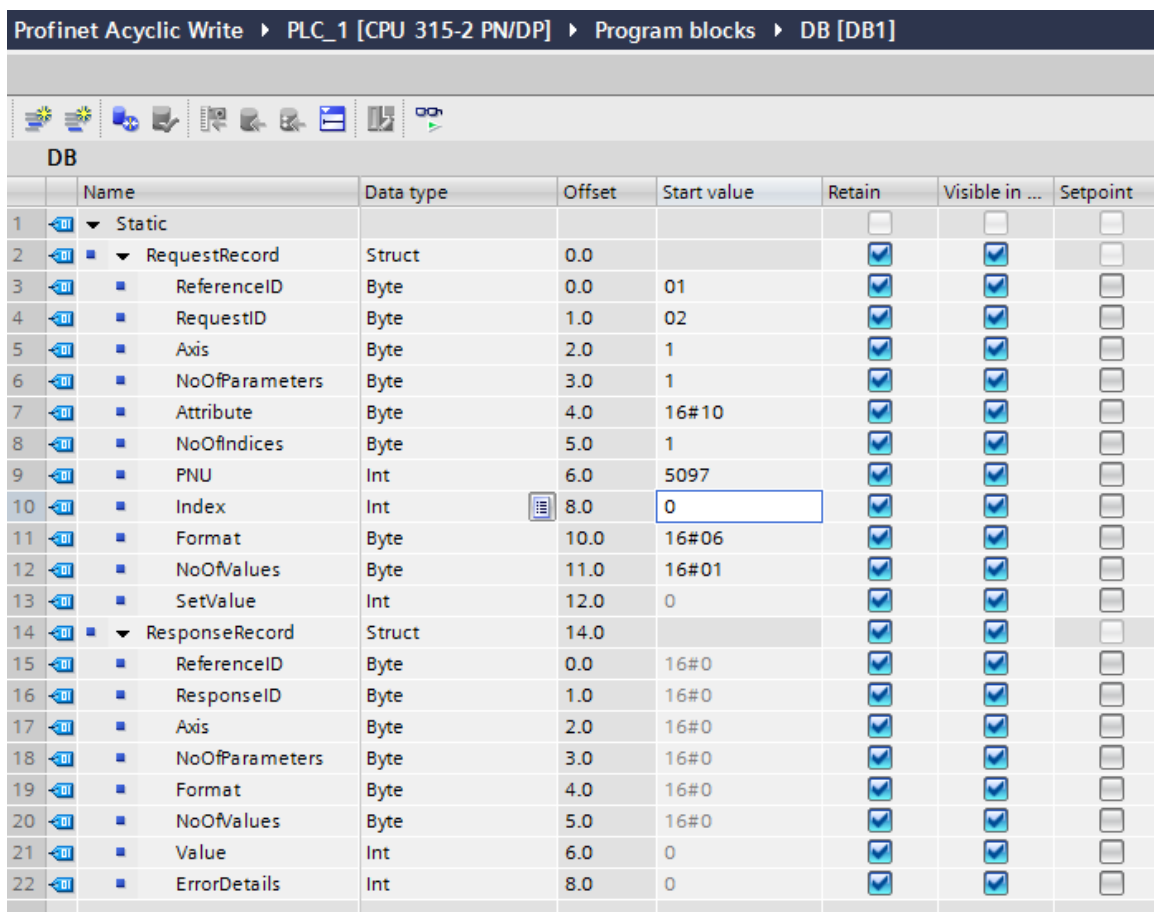

Creating the request

Modify the ladder network initiating the sequence, to set the value of field *SetValue* in the *RequestRecord* structure. This is the value that will be written to the requested PNU.

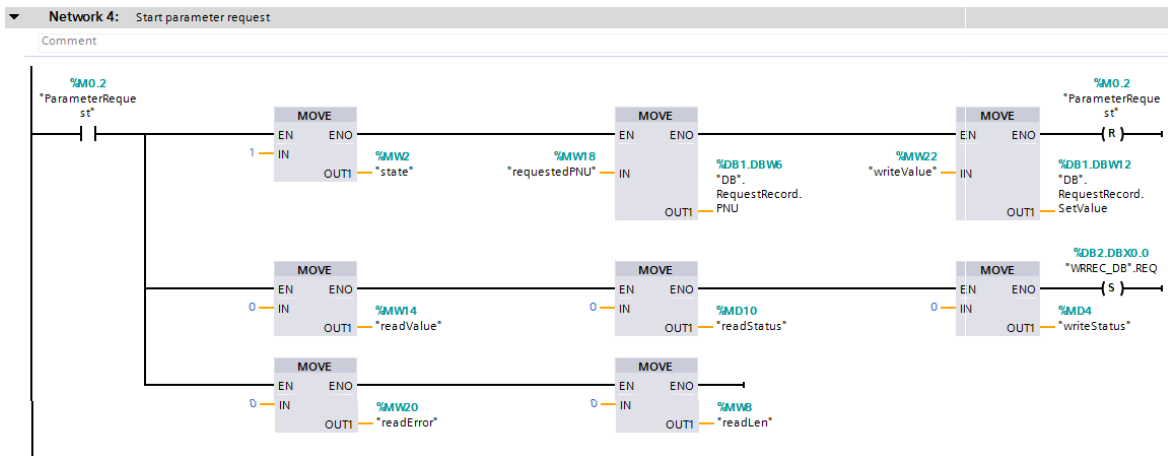

Modify the network responsible for processing of the read request response. A positive response will have ID 0x02, while a negative response ID 0x82.

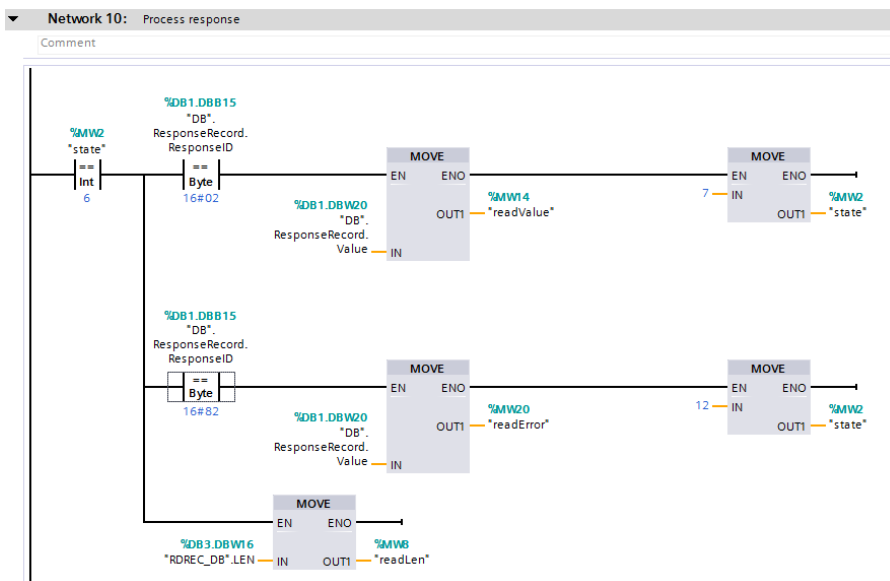

Finally change the length of the write request to 14 bytes.

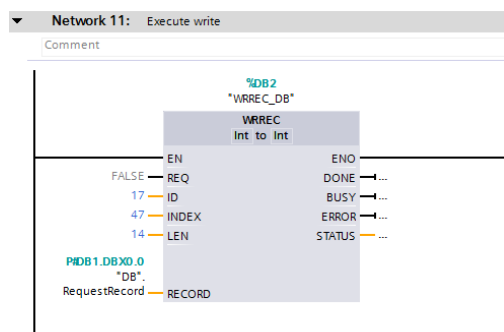

Executing example requests

To perform a parameter write, set the PNU of the parameter to change in *requestedPNU*. As an example, to change parameter 15 (Jog frequency), add the offset 5096 and write the result (5111) to variable *requestedPNU*. The value that will be set, will be the output of multiplication of the set value, and the minimum setting increments, as according to the parameter list in the inverter manual. For parameter 15, the minimum setting increment is 0.01Hz. If a jog frequency of 5Hz is requested, set *writeValue* to 500. Finally execute the request by setting bit *ParameterRequest* to ON. A successful write will result in entering state 7.

Profinet Acyclic Write > PLC_1 [CPU 315-2 PN/DP] > Watch and force tables > Watch table_1

#	Name	Address	Display format	Monitor value	Modify value	
1	"Initialize"	%M0.0	Bool	<input type="checkbox"/> FALSE	FALSE	<input type="checkbox"/>
2	"RotationCommand"	%M0.1	Bool	<input type="checkbox"/> FALSE	FALSE	<input type="checkbox"/>
3	"state"	%MW2	DEC+/-	7	0	<input type="checkbox"/>
4	"requestedPNU"	%MW18	DEC+/-	5111	5111	<input checked="" type="checkbox"/>
5	"ParameterRequest"	%M0.2	Bool	<input type="checkbox"/> FALSE	TRUE	<input checked="" type="checkbox"/>
6	"writeStatus"	%MD4	Hex	16#0000_0000	16#0000_0000	<input type="checkbox"/>
7	"readStatus"	%MD10	Hex	16#0000_0000	16#0000_0000	<input type="checkbox"/>
8	"readError"	%MW20	DEC+/-	0		<input type="checkbox"/>
9	"writeValue"	%MW22	DEC+/-	500	500	<input checked="" type="checkbox"/>
10		<Add new>				<input type="checkbox"/>

Test receiving a negative response, by trying to write an out of range value. After trying to write 0xFFFF as the value of parameter 15, state 12 will be entered indicating a negative response with error code 0x02 (LOW_OR_HIGH_LIMIT_EXCEEDED) stored in *readError* tag, which is the expected behavior.

Profinet Acyclic Write > PLC_1 [CPU 315-2 PN/DP] > Watch and force tables > Watch table_1

#	Name	Address	Display format	Monitor value	Modify value	
1	"Initialize"	%M0.0	Bool	<input type="checkbox"/> FALSE	FALSE	<input type="checkbox"/>
2	"RotationCommand"	%M0.1	Bool	<input type="checkbox"/> FALSE	FALSE	<input type="checkbox"/>
3	"state"	%MW2	DEC+/-	12	0	<input type="checkbox"/>
4	"requestedPNU"	%MW18	DEC+/-	5111	5111	<input checked="" type="checkbox"/>
5	"ParameterRequest"	%M0.2	Bool	<input type="checkbox"/> FALSE	TRUE	<input checked="" type="checkbox"/>
6	"writeStatus"	%MD4	Hex	16#0000_0000	16#0000_0000	<input type="checkbox"/>
7	"readStatus"	%MD10	Hex	16#0000_0000	16#0000_0000	<input type="checkbox"/>
8	"readError"	%MW20	DEC+/-	2		<input type="checkbox"/>
9	"writeValue"	%MW22	Hex	16#FFFF	16#FFFF	<input checked="" type="checkbox"/>
10		<Add new>				<input type="checkbox"/>

3.13 SIMATIC STEP7 example

3.13.1 Creating a Configuration

This section describes a simple example on how to configure a PROFINET network including an A8NPRT_2P PROFINET Option Board using the SIMATIC STEP7 configuration tool. Please consult the SIMATIC STEP7 instruction manual or online help for further information on how to use the tool.

The configuration is created offline and downloaded to the network when it is finished.

- ① Open SIMATIC STEP7.
- ② Select Options - Install GSD.

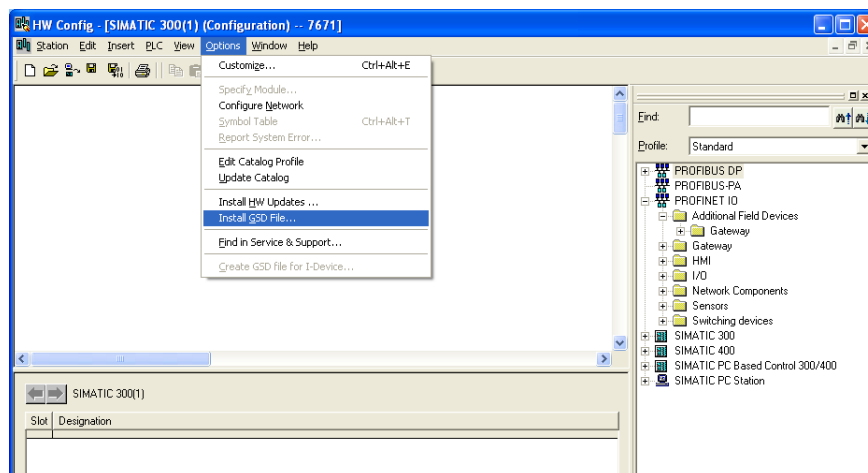

- ③ Browse for the correct GSD-file to use with the option board. Select file and click Install.

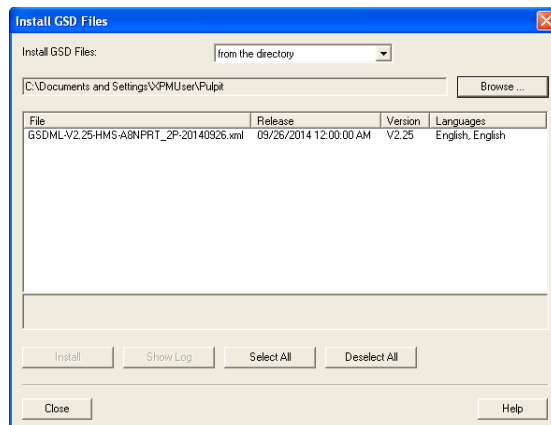

- ④ Select PLC and drag an instance of the selected PLC into the configuration window.

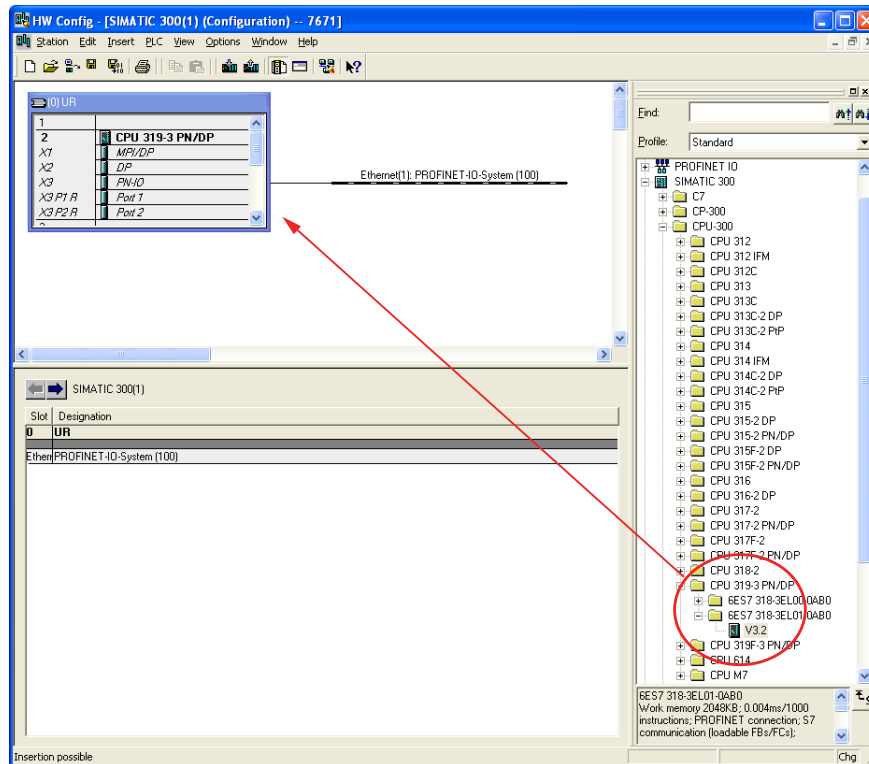

- ⑤ Locate the option board in the HW catalog (PROFINET IO -> Additional Field Devices -> Drives).

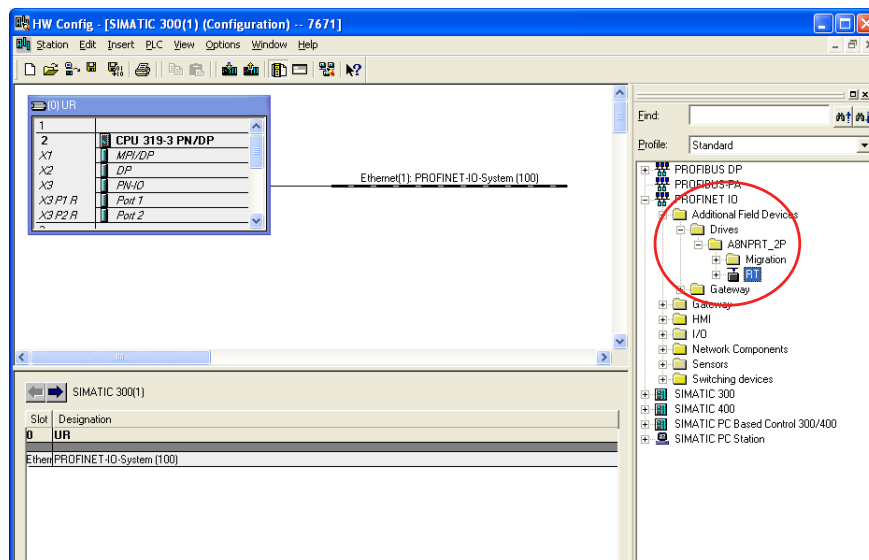

- ⑥ Drag and drop an instance of the option board to the configuration.

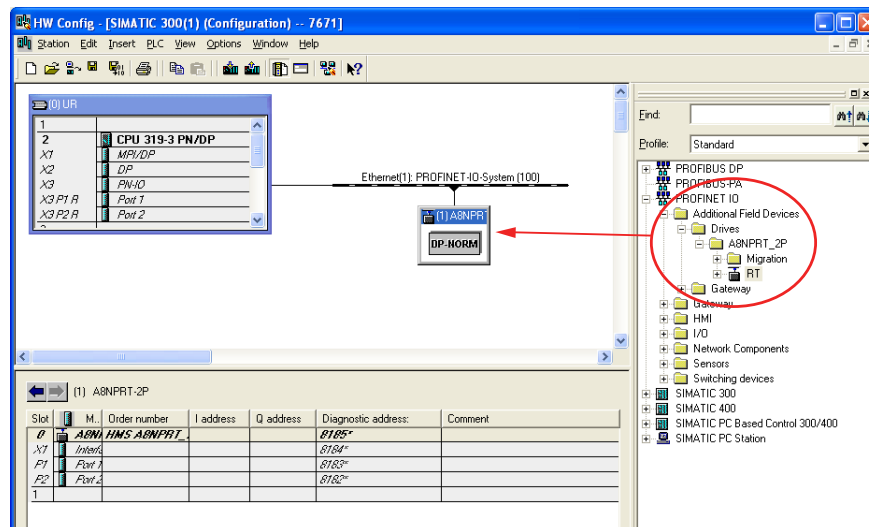

- ⑦ With the option board selected, right click and open Object Properties from the menu in the pop-up window. Select the General tab. Enter Device Name (Station Name) and check "Assign IP address via IO controller".

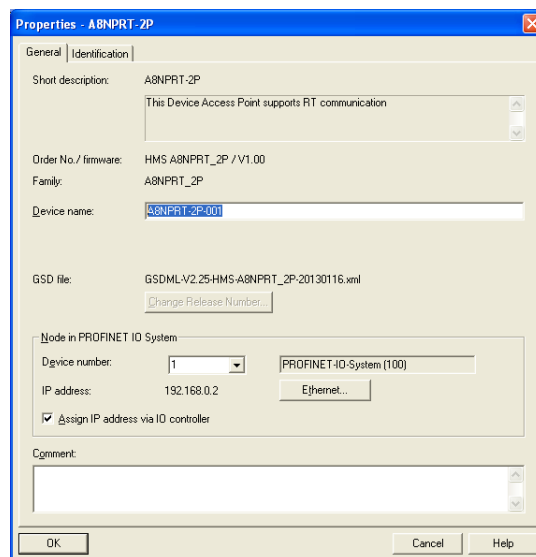

- ⑧ Select Parameters tab. Select subnet and enter the IP address of the option board. This address will be assigned to the option board by the PLC when the configuration is downloaded to the network. Click OK.

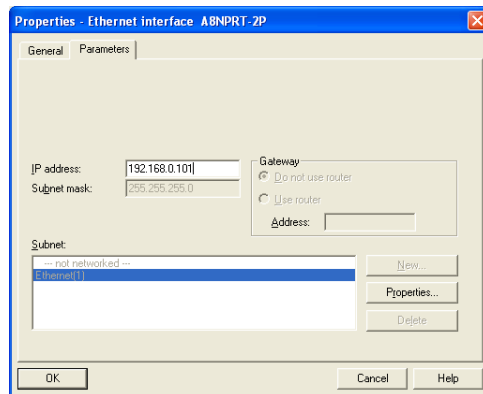

- ⑨ Select and drag and drop telegram to option board. The telegrams are found in the HW catalog with the option board.

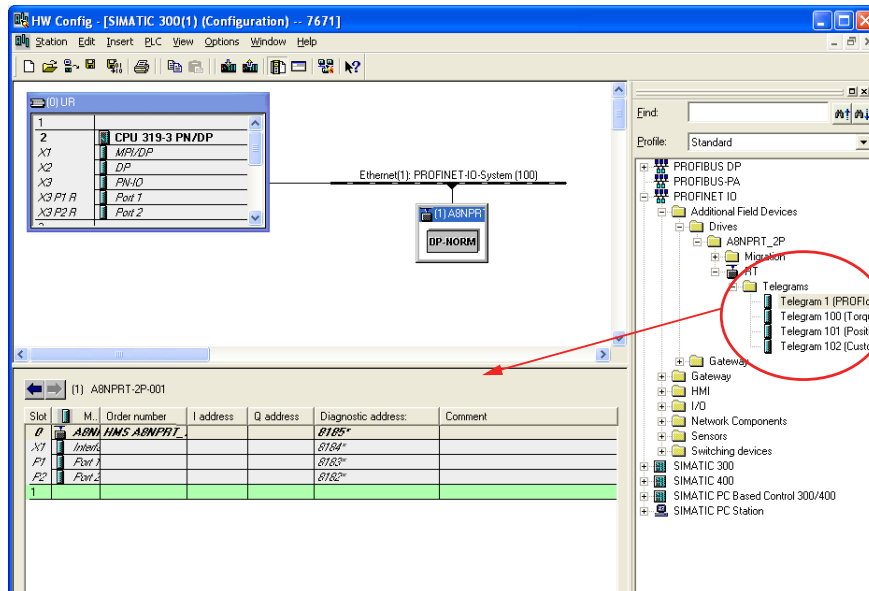

- ⑩ With the new telegram instance selected, right click and open the Telegram Properties window from the pop-up menu. Enter a name for the telegram and map the cyclic data in the telegram.

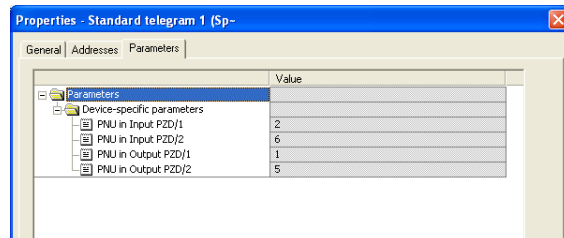
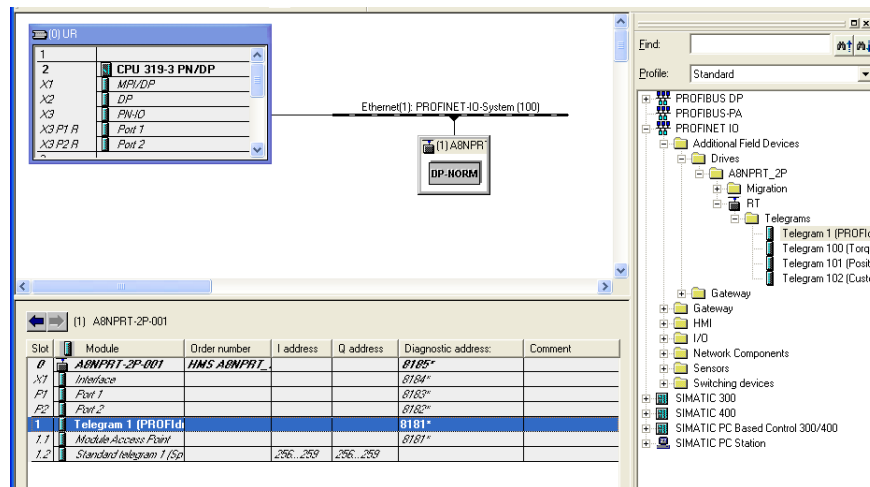

- ⑪ Repeat until all devices are entered into the configuration.

3.13.2 Download Configuration to the PLC

The configuration of the PROFINET network is built offline. To download the configuration to the PLC that acts as master for the network, follow the steps below:

- ① Connect to network.
- ② Select a node and open the Edit Ethernet Node window.

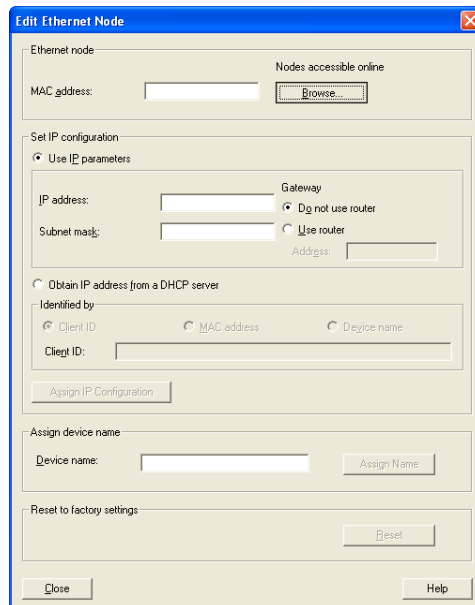
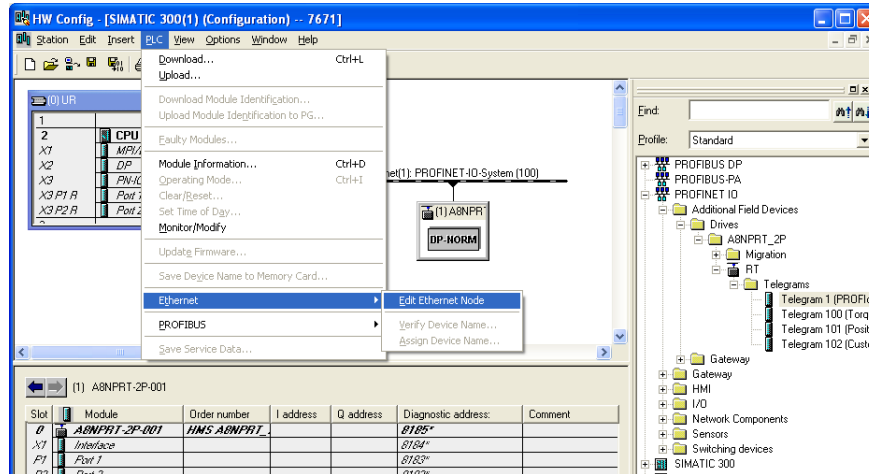

- ③ Click Browse to start scanning for devices on the network. This will produce a list of available units.

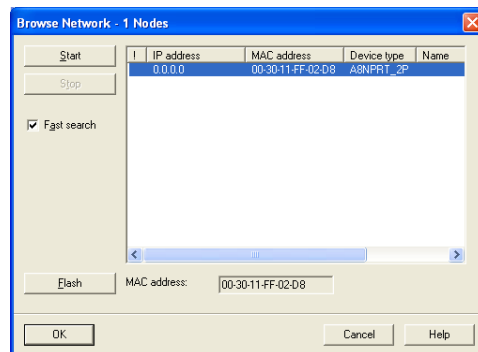
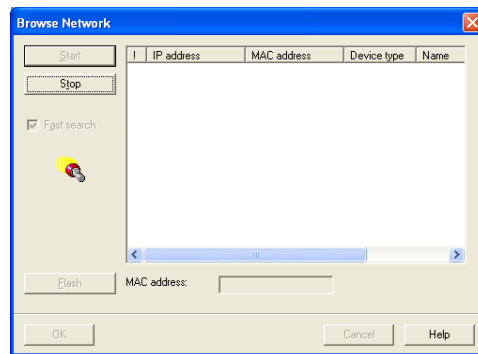

- ④ Find the correct unit by the MAC address. Select and confirm using the button "Flash".

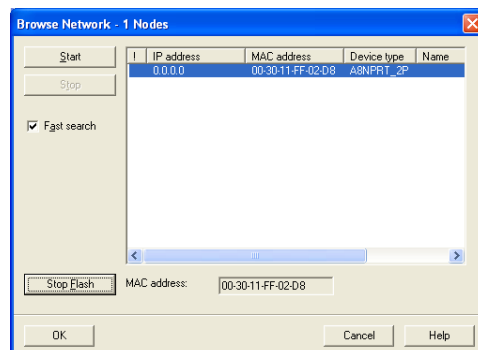

- ⑤ Allocate station name (device name). The PLC will allocate correct IP address at download. Repeat steps 4 and 5 for each unit in the network.

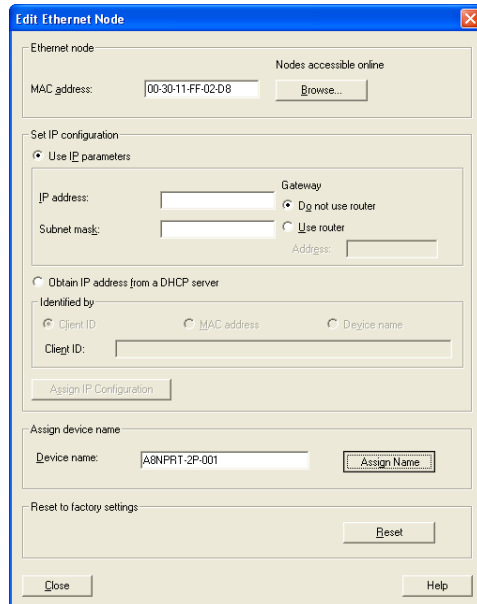

- ⑥ Download configuration to network, either by selecting PLC -> Download... or by clicking on the download symbol.

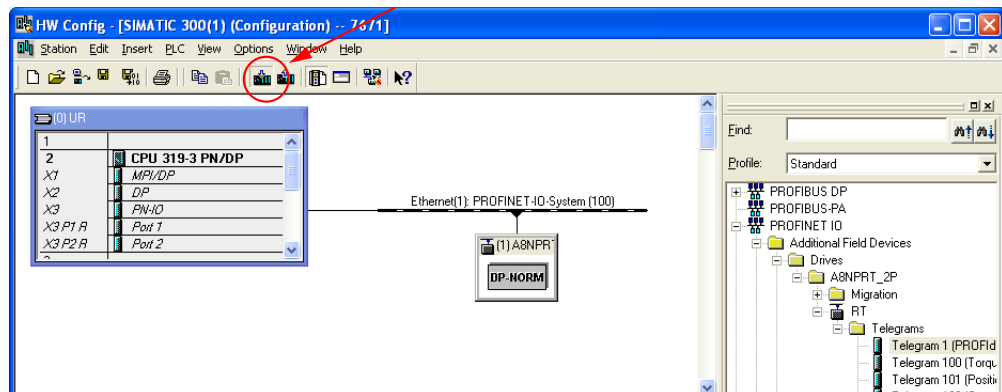

3.13.3 Run

Set the PLC in RUN mode.

3.14 Parameter Settings

Parameters can be set at run time either using the internal web pages of the option board or the hand-held parameter unit. The values of some of the parameters will not be valid until the inverter has been restarted.

The following information can be seen, and in certain cases changed, from the web pages:

- IP settings (requires a restart to take effect)
- Parameter data, including drive profile parameters
- Drive Monitor

For more information on what the webpages look like, what information you can find there and what parameters you can change the value of, see “Embedded Web Server” on page 77.

3.14.1 Parameter Unit

Parameter data can be seen, and in certain cases changed from the parameter unit.

For more information, please consult the manual for the FR-A800 series frequency inverter.

4. Inverter Settings

4.1 Inverter Parameters

The inverter parameters are critical for overall operation of the end-to-end communication system. Some of these parameters must be set to specific values, and some may have multiple allowable settings depending on the desired operation of the overall application. It is important to understand the manner in which the parameters will impact successful communications with, and control of the inverter.

The inverter parameters can be changed either via the handheld parameter unit or via the web pages of the option board. The handheld parameter unit is described in the user manual for the FR-A800 series, and the option board web pages are described in "Web Pages" on page 78.

Note: The scaling of the parameter values are different if you use the parameter unit or the option board web pages, for further information see "Parameter Data" on page 81.

4.2 Option Board Parameters

The option board parameters are stored in the inverter. At startup they are transferred from the inverter to the option board and can be changed using the parameter unit or the option board web pages.

No (dec)	No (hex)	Parameter Name.	Description
1300	514h	Option parameter 1	General settings, see "Parameter 1300 (514h, General Settings)" on page 72
1301	515h	Option parameter 2	Ethernet Host Settings, see "Parameter 1301 (515h, Ethernet Host Settings)" on page 73
1302	516h	Option parameter 3	Network Type ¹
1303	517h	Option parameter 4	Serial number (low word) ²
1304	518h	Option parameter 5	Serial number (high word) ²
1305	519h	Option parameter 6	IP address (first byte), see "Parameters 1305 - 1308 (519h - 51Ch, IP Address)" on page 73
1306	51Ah	Option parameter 7	IP address (second byte)
1307	51Bh	Option parameter 8	IP address (third byte)
1308	51Ch	Option parameter 9	IP address (fourth byte)
1309	51Dh	Option parameter 10	Subnet mask (first byte), see "Parameters 1309 - 1312 (51Dh - 520h, Subnet Mask)" on page 73
1310	51Eh	Option parameter 11	Subnet mask (second byte)
1311	51Fh	Option parameter 12	Subnet mask (third byte)
1312	520h	Option parameter 13	Subnet mask (fourth byte)
1313	521h	Option parameter 14	Gateway address (first byte), see "Parameters 1313 - 1316 (521h - 524h, Gateway Address)" on page 73
1314	522h	Option parameter 15	Gateway address (second byte)
1315	523h	Option parameter 16	Gateway address (third byte)
1316	524h	Option parameter 17	Gateway address (fourth byte)
1317	525h	Option parameter 18	Ethernet Communication Settings, see "Parameter 1317 (525h, Ethernet Communication Settings)" on page 74
1318 - 1343	526h - 53Fh	Option parameter 19 - 44	Network specific 1 - 26

¹ During startup the option board will verify the value of this parameter. If it differs from the network type of the option board, the option board will change the parameter value to the actual network type and clear all other parameters.

² During startup the option board will verify the value of this parameter. If it differs from the serial number of the option board, the option board will change the parameter value to the actual serial number and also set the option board host name to [main-unit-name]-[serial number]

The option board and the inverter start up with default standard settings. Any changes of the parameter values during runtime, will not be available until the inverter has been restarted.

The application can more often than not be run on standard settings.

Parameter 1300 (514h, General Settings)

Only read by the option board during startup.

Bit	Name	Default	Description
0 - 3	(reserved)	0	N/A
4	Clear all Option Parameters	0	Will clear all option parameters and set the default values when set to 1. Resets itself to False (0) after completion.
5 - 15	(reserved)	0	N/A

Parameter 1301 (515h, Ethernet Host Settings)

Only read by the option board during startup.

Note: For these settings to be used, parameter 1317 (525h) has to be set to 1.

Bit	Name	Default	Description
0	HICP	0	0: Enables support for the HICP protocol used by the Anybus IPconfig utility. 1: Disables support for the HICP protocol.
1	Web Server	0	0: Enables the built-in web server. 1: Disables the built-in web server.
2	Web ADI access ¹	0	0: Enables access to inverter parameters from the web server. 1: Disables access to inverter parameters from the web servers.
3	FTP server	0	0: Enables the built-in FTP server. 1: Disables the built-in FTP server.
4	Admin mode	0	0: Disables FTP admin mode. 1: Enables FTP admin mode.
5	(reserved)	0	N/A
6	Format file system	0	0: Default 1: Formats the file system. Will reset itself to False (0) after completion.
7-15	(reserved)	0	N/A

¹ Web server must be enabled.

Parameters 1305 - 1308 (519h - 51Ch, IP Address)

These four parameters store the IP Address of the option board. Byte order is allocated as in the following example:

IP address:	192. 168. 111. 222
Parameter no (hex):	519 51A 51B 51C
Parameter no (dec):	1305 1306 1307 1308

Parameters 1309 - 1312 (51Dh - 520h, Subnet Mask)

These four parameters store the subnet mask. Byte order is allocated as in the following example:

IP address:	255. 255. 255. 0
Parameter no (hex):	51D 51E 51F 520
Parameter no (dec):	1309 1310 1311 1312

Parameters 1313 - 1316 (521h - 524h, Gateway Address)

These four parameters store the gateway address of the option board. Byte order is allocated as in the following example:

IP address:	192. 168. 111. 1
Parameter no (hex):	521 522 523 524
Parameter no (dec):	1313 1314 1315 1316

Parameter 1317 (525h, Ethernet Communication Settings)

Only read by the option board during startup.

Note: If the settings of parameter 1305 are to be used by the option card, this parameter must be set to 1.

Bit	Name	Default	Values	Description
0	Priority of setting	0	0: 1:	Option board settings are used for network settings. Option board parameters (inverter parameter data) are used for network settings.
1	DHCP ¹	0	0: 1:	DHCP is enabled DHCP is disabled
2-15	(reserved)	0	N/A	

¹ The value of this bit is ignored if bit 0 (Priority of setting) of the parameter is set to 0 (default).

4.3 Operation Mode Setting

Please refer to the FR-A800 instruction manual for information.

5. Identifying the Option Board

A device on a PROFINET network is primarily defined by its station name (device name). To be able to take advantage of the internal web pages of the option board, the user needs to identify the option board on the network through its IP address. The PROFINET master may assign an IP address to a device, but an IP address can be assigned separately as well.

The station (device) name is assigned through the Siemens Primary Setup Tool or the “Edit ethernet node” option in STEP7.

5.1 Siemens Primary Setup Tool

The Siemens Primary Setup Tool can be used to find all devices on a PROFINET network. The tool is installed together with STEP7. The same functionality is available when selecting “Edit ethernet node” in STEP7.

Locate your device in the MAC address list¹. This list is presented by the tool. If you select module-flash for that device, the module status LED of the device will start flashing. Set a station name for the device.

Clicking on the device will show the network settings, including the possibility to assign/change an IP address, for the device.

5.2 IP Address

At startup, the master will address the option board using the station name. The option board responds with (among other things) its IP address, if assigned.

An IP address can be assigned to the A8NPRT_2P PROFINET Option Board in different ways:

- An IP address can be assigned to the option board during configuration
- The IP address, subnet mask and gateway address can be assigned using the parameter unit. For more information see “Option Board Parameters” on page 72.
- DHCP is disabled by default for the PROFINET option board, but will, if enabled, automatically assign an IP address to the option board.
- Once an initial IP address has been assigned to the device and the configuration web page can be accessed, the IP address related parameters can also be modified via the web page.

If HICP² is enabled in option board parameter 515h, the Anybus IPconfig tool³ can be used to find the option board on the network.

¹ The MAC address is printed on the option board.

² For more information see “HICP (Host IP Configuration Protocol)” on page 111.

³ Available for download from www.anybus.com.

6. Embedded Web Server

6.1 Overview

The interface contains an embedded web server (also known as an HTTP server), which allows users to access the inverter's internal data with web browsers such as Microsoft Internet Explorer or Mozilla Firefox. In this way, the inverter can be monitored, configured and controlled from across the room or from across the globe.

To access an interface's embedded web server, either use the IPConfig Tool and select the "Open Web Interface" button when the target unit is highlighted, or just directly enter the target unit's IP address into the address (URL) field of your web browser.

The web server supports up to 20 concurrent connections and communicates through port 80.

6.2 Authorization

Directories can be protected from web access by placing a file called 'web_accs.cfg' in the directory to protect.¹ This file shall contain a list of users that are allowed to access the directory and its subdirectories.

File Format:

```
Username1:Password1
Username2:Password2
...
UsernameN:PasswordN
```

— List of approved users.

```
[AuthName]
(message goes here)
```

— Optionally, a login message can be specified by including the key [AuthName]. This message will be displayed by the web browser upon accessing the protected directory.

The list of approved users can optionally be redirected to one or several other files.

Example:

In this example, the list of approved users will be loaded from 'here.cfg' and 'too.cfg'.

```
[File path]
|i\put\some\over\here.cfg
|i\actually\put\some\of\it\here\too.cfg

[AuthName]
Howdy. Password, please.
```

¹ For more information about the file system, see "File System and FTP Server" on page 85.

6.3 Web Pages

Open a web browser (IE or Firefox e.g.). Enter the IP address for the option board. The window pane below will appear:

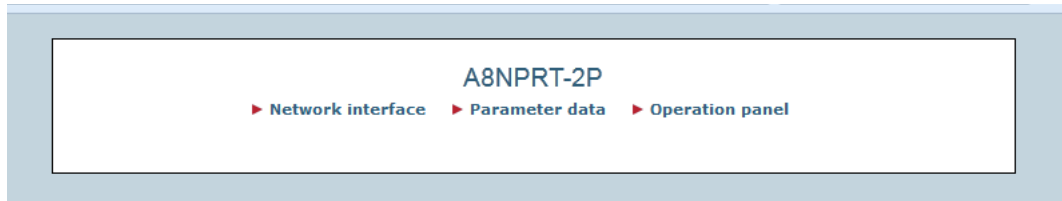

The index page gives access to the following pages:

- Network interface
- Parameter data
- Operation panel

6.3.1 Network Interface

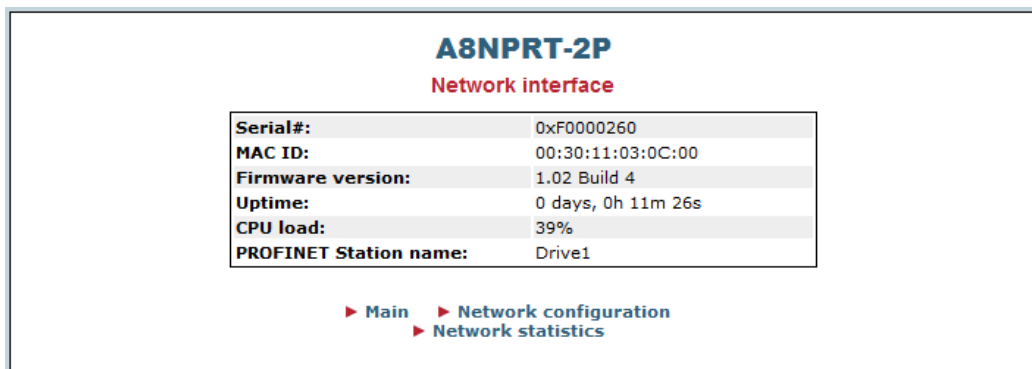

The following information is available on the network interface page:

Name	Description
Serial#	The serial number of the option board.
MAC ID	The MAC ID of the option board.
Firmware version	The firmware version of the option board.
Uptime	The uptime of the option board.
CPU load	Current CPU load of the option board.
PROFINET station name	The currently set station name of the option board.

From this web page you can continue to:

- Network configuration
- Network statistics

Network Configuration Page

The network configuration page provides an interface for configuring the network settings. The module needs a reset for the changes to take effect.

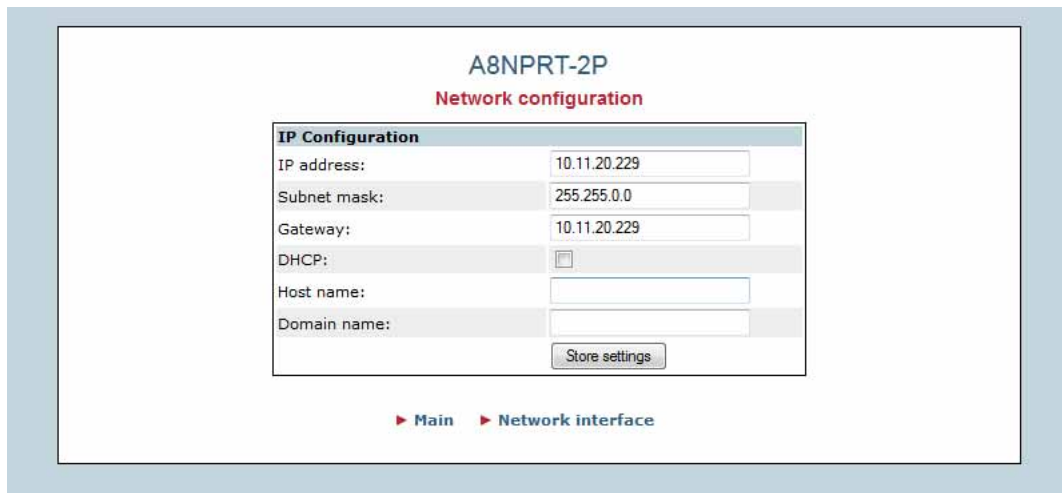

Available editable settings:

Name	Description
IP address	The TCP/IP settings of the module
Subnet mask	Default values: 0.0.0.0
Gateway	Valid values: 0.0.0.0 - 255.255.255.255
DHCP	Enabling or disabling DHCP Default: Disabled
Host name	IP address or name Max 64 characters Default: [inverter name]-[serial number] e.g. FR-A820-1234ABCD
Domain name	IP address or name Max 48 characters

Ethernet Statistics Page

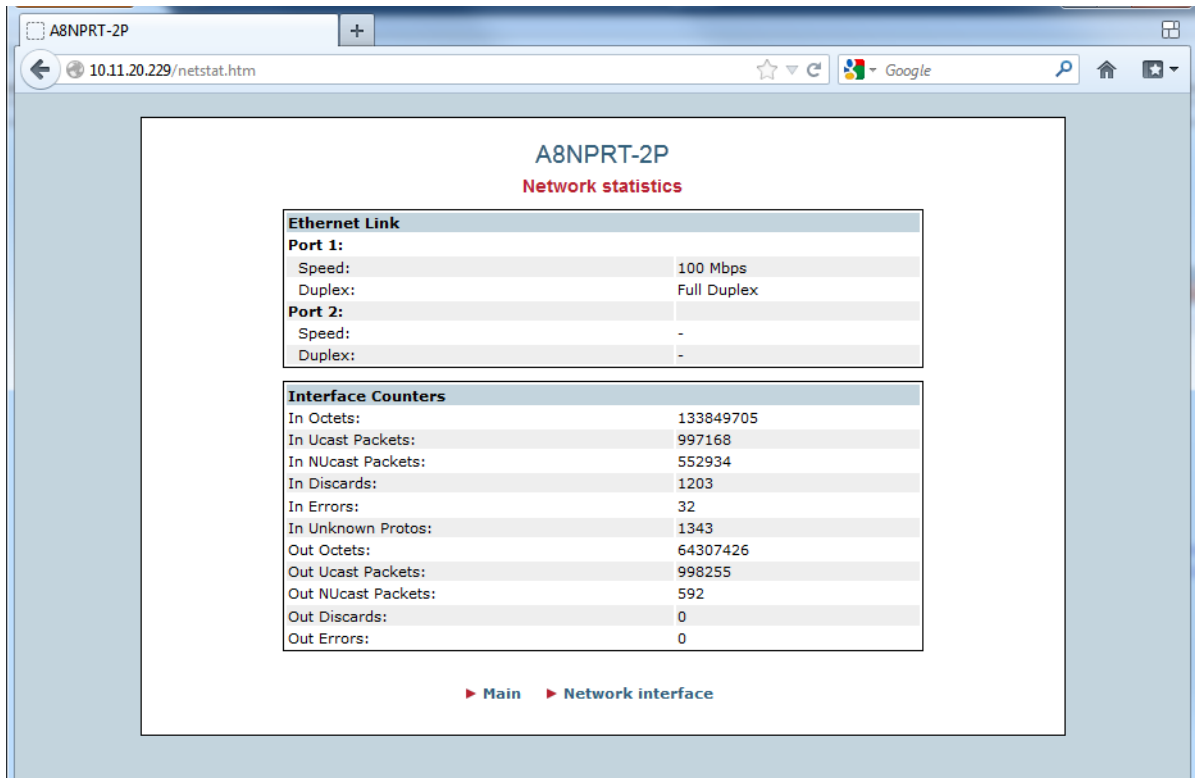

The Ethernet statistics web page contains the following information:

Ethernet Link		Description
Port 1	Speed	The current link speed
	Duplex	The current duplex configuration
Port 2	Speed	The current link speed
	Duplex	The current duplex configuration

Interface Counters	Description
In Octets	Received bytes
In Ucast packets	Received unicast packets
In NUCast packets	Received non-unicast packets (broadcast and multicast)
In Discards	Received packets discarded due to no available memory buffers
In Errors	Received packets discarded due to reception error
In Unknown Protos	Received packets with unsupported protocol type
Out Octets	Sent bytes
Out Ucast packets	Sent unicast packets
Out NUCast packets	Sent non-unicast packets (broadcast and multicast)
Out Discards	Outgoing packets discarded due to no available memory buffers
Out Errors	Transmission errors

6.3.2 Parameter Data

In the Parameter Data web page, all the parameters and cyclic monitor data of the inverter can be accessed. The available parameters correspond to parameters with PNU 5096...16388 using the PROFIdrive parameter protocol.

A8NPRT-2P

Parameter data

Number of parameters per page:

#	Parameter	Value	
1	Parameter# 0	<input type="text" value="60"/>	<input type="button" value="Set"/>
2	Parameter# 1	<input type="text" value="12000"/>	<input type="button" value="Set"/>
3	Parameter# 2	<input type="text" value="0"/>	<input type="button" value="Set"/>
4	Parameter# 3	<input type="text" value="6000"/>	<input type="button" value="Set"/>
5	Parameter# 4	<input type="text" value="6000"/>	<input type="button" value="Set"/>
6	Parameter# 5	<input type="text" value="28"/>	<input type="button" value="Set"/>
7	Parameter# 6	<input type="text" value="1000"/>	<input type="button" value="Set"/>
8	Parameter# 7	<input type="text" value="50"/>	<input type="button" value="Set"/>
9	Parameter# 8	<input type="text" value="50"/>	<input type="button" value="Set"/>
10	Parameter# 9	<input type="text" value="255"/>	<input type="button" value="Set"/>

1-10	11-20	21-30	31-40	Next >>
41-50	51-60	61-70	71-80	
81-90	91-100	101-110	111-120	
121-130	131-140	141-150	151-160	
161-170	171-180	181-190	191-200	
201-210	211-220	221-230	231-240	
241-250	251-260	261-270	271-280	
281-290	291-300	301-310	311-320	
321-330	331-340	341-350	351-360	
361-370	371-380	381-390	391-400	
401-410	411-420	421-430	431-440	
441-450	451-460	461-470	471-480	
481-490	491-500	501-510	511-520	
521-530	531-540	541-550	551-560	
561-570	571-580	581-590	591-600	
601-610	611-620	621-630	631-640	
641-650	651-660	661-670	671-680	
681-690	691-700	701-710	711-720	
721-730	731-740	741-750	751-760	
761-770	771-780	781-790	791-800	
801-810	811-819			

[▶ Main](#)

Please note that all values have to be scaled to conform to the values shown in the hand-held parameter unit. The scaling factor is specific to each parameter and listed in the inverter manual. The value shown on the web page has to be multiplied by this scaling factor. The picture below shows the web pages including the scaling factor for each parameter. See "Download" on page 1 for websites where these web pages are available for download.

A8NPRT-2P

Parameter data

Number of parameters per page:

#	Parameter	Unit	Value	
1	Pr.0 Torque boost	0.1%	<input type="text" value="20"/>	<input type="button" value="Set"/>
2	Pr.1 Maximum frequency	0.01Hz	<input type="text" value="12000"/>	<input type="button" value="Set"/>
3	Pr.2 Minimum frequency	0.01Hz	<input type="text" value="0"/>	<input type="button" value="Set"/>
4	Pr.3 Base frequency	0.01Hz	<input type="text" value="6000"/>	<input type="button" value="Set"/>
5	Pr.4 Multi-speed setting (high speed)	0.01Hz	<input type="text" value="6000"/>	<input type="button" value="Set"/>
6	Pr.5 Multi-speed setting (middle speed)	0.01Hz	<input type="text" value="3000"/>	<input type="button" value="Set"/>
7	Pr.6 Multi-speed setting (low speed)	0.01Hz	<input type="text" value="1000"/>	<input type="button" value="Set"/>
8	Pr.7 Acceleration time	0.1s	<input type="text" value="0"/>	<input type="button" value="Set"/>
9	Pr.8 Deceleration time	0.1s	<input type="text" value="0"/>	<input type="button" value="Set"/>
10	Pr.9 Electronic thermal O/L relay	0.01A	<input type="text" value="4600"/>	<input type="button" value="Set"/>

1-10
11-20
21-30
31-40
Next >>

41-50
51-60
61-70
71-80

81-90
91-100
101-110
111-120

121-130
131-140
141-150
151-160

161-170
171-180
181-190
191-200

201-210
211-220
221-230
231-240

241-250
251-260
261-270
271-280

281-290
291-300
301-310
311-320

321-330
331-340
341-350
351-360

361-370
371-380
381-390
391-400

401-410
411-420
421-430
431-440

441-450
451-460
461-470
471-480

481-490
491-500
501-510
511-520

521-530
531-540
541-550
551-560

561-570
571-580
581-590
591-600

601-610
611-620
621-630
631-640

641-650
651-660
661-670
671-680

681-690
691-700
701-710
711-720

721-730
731-740
741-750
751-760

761-770
771-780
781-790
791-800

801-810
811-820
821-830
831-840

841-850
851-860
861-870
871-880

881-890
891-900
901-906

▶ Main

6.3.3 Drive Monitor

This webpage makes it possible to monitor actual values from the device.

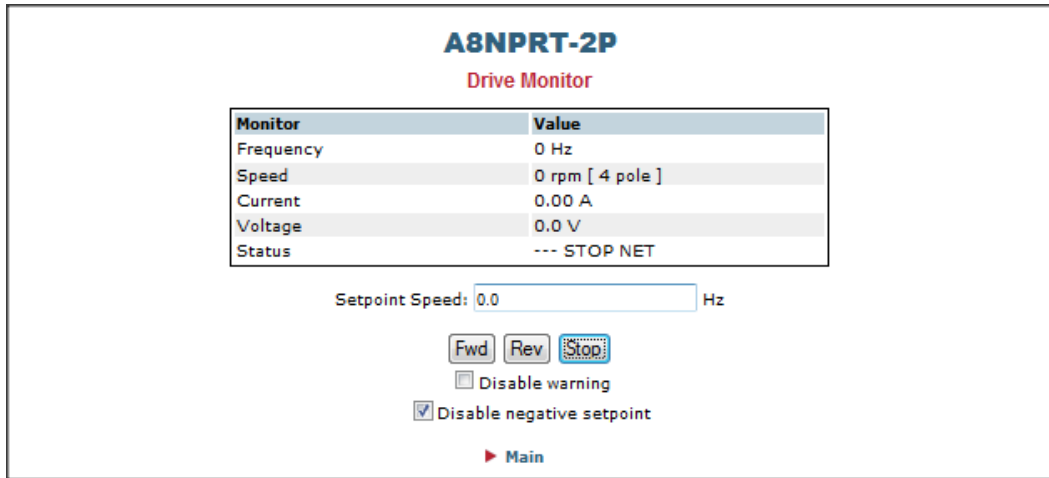

The Forward (Fwd), Reverse (Rev) and Stop buttons allow the user to start forward rotation or reverse rotation of the drive, as well as to stop the drive.

Using the Fwd, Rev or Stop buttons will make a confirmation window appear. Press the OK button to confirm, or the Cancel button to cancel. If the "Disable warning" checkbox is checked, no confirmation window will appear.

7. File System and FTP Server

7.1 General

The file system of the option board is used to store files used by the application firmware, e.g. configuration files.

Whenever the configuration is completed, it is suggested that a backup copy of the configuration file be downloaded from the unit to a PC. One reason for this is if it becomes necessary to restore a previous configuration at a later time. Another reason is that it may be desirable to use the same configuration for multiple units. A downloaded configuration file can be uploaded again to any compatible unit, allowing the user to easily clone multiple units with the same configuration.

Interacting with the file system is performed by use of the File Transfer Protocol (FTP). The built-in FTP server makes it easy to manage the file system using a standard FTP client, interacting with the files in the same manner as though they were traditional files stored on a local or remote PC.

Note that certain routers or firewall applications (such as Windows Firewall) can block FTP traffic. If an FTP connection to the option board cannot be established, be sure to check the computer's firewall settings during troubleshooting, and add an exception to the firewall configuration if necessary.

7.2 FTP Server

7.2.1 Initiation

By default, the following port numbers are used for FTP communication:

- TCP, port 20 (FTP data port)
- TCP, port 21 (FTP command port)

The FTP server supports up to 8 concurrent connections.

7.2.2 User Accounts

User accounts are stored in the configuration file '\ftp.cfg'. This file holds the usernames, passwords, and home directory for all users. Users are not able to access files outside of their home directory.

The FTP password protects removal and replacement of downloaded web-pages in the module even if actual web-access has separate passwords.

File Format:

```
User1:Password1:Homedir1  
User2:Password2:Homedir2  
User3:Password3:Homedir3
```

Optionally, the UserN:PasswordN-section can be replaced by a path to a file containing a list of users as follows:

File Format ('\ftp.cfg'):

```
User1:Password1:Homedir1
User2:Password2:Homedir2
\path\userlistA:HomedirA
\path\userlistB:HomedirB
```

The files containing the user lists shall have the following format:

File Format:

```
User1:Password1
User2:Password2
User3:Password3
```

Notes:

- Usernames must not exceed 15 characters in length.
 - Passwords must not exceed 15 characters in length.
 - User names and passwords must only contain printable characters in the Lower ASCII characters set (value 32 to 127). Delimiter character ':' must not be used as part of the username or password. Character '\' must not be used as the first character of the user name.
 - File must be stored using ANSI encoding.
 - If '\ftp.cfg' is missing or cannot be interpreted, all username/password combinations will be accepted and the home directory will be the FTP root (i.e. '\ftp\').
 - The home directory for a user must also exist in the file system if they should be able to log in, just adding the user information to the 'ftp.cfg' file it is not enough.
 - If 'Admin Mode' has been enabled in the Option Board parameters, all username/password combinations will be accepted and the user will have unrestricted access to the file system (i.e. the home directory will be the system root).
 - It is strongly recommended to have at least one user with root access ('\') permission. If not, 'Admin Mode' must be enabled each time a system file needs to be altered (including '\ftp.cfg').
-

8. PROFINET Implementation

The option board implements PROFINET and PROFIdrive according to standard.

8.1 General

The A8NPRT_2P PROFINET Option Board complies to PROFINET specification v2.2, conformance class B.

Performance:

- 100 Mbps, full duplex with auto-negotiation enabled as default
- Real Time (RT) communication, 2 ms cycle time

Device Model

- One IO Device instance
- Each IO Device instance includes one or more Application Processes represented by identifiers (API)
- API 0 (zero) and API 14848 (PROFIdrive API) are implemented
- Each API implements one or more slots
- Each Slot implements one or more subslots
- Each subslot may implement one or more Channels

Slots & Subslots

One slot available for a selection of telegram types. Each module contains a MAP (Module Access Point) and a PROFIdrive telegram submodule (standard or device specific).

8.2 Electronic Data Sheet (GSD)

A standard GSD file is available for download at the Mitsubishi Electric web site, see section "Download" on page 1.

8.3 Fast Start Up

The Fast Start Up function enables PROFINET IO devices, connected to the network, to power up quickly, this is useful in for example robot applications, where rapid retooling is necessary. This function has to be activated when configuring the option board.

8.4 DAP

A DAP (Device Access Point) is a module that is representative of the unit. The default DAP is compatible with PROFINET version 2 but there is an alternative DAP supplied for compatibility with older PROFINET versions (V1.5).

8.5 I&M

Identification & Maintenance (I&M) provides a standard way of gathering information about an I/O device. The I&M information can be accessed by the IO Controller by means of acyclic Record Data Read/Write services.

The option board provides support for I&M 0-4 data.

9. Data Exchange

9.1 General Information

Inverter parameters can be accessed acyclically by means of the PROFIdrive Parameter Protocol. The master issues a parameter request to the option board. The option board processes the request. Meanwhile the master repeatedly tries to read the parameter response, but an error message will be returned until the request is fully processed by the module, after which the master can read the response.

Translation of signal numbers

Signal numbers used in the inverter do not directly translate to signal numbers (PNUs) used on PROFINET. An offset is added to avoid ambiguous numbering on PROFINET, where parameters and monitor data have different PNU numbers.

The array below presents a summary of the signal number translation. For a complete presentation of how to translate the signal numbers for the option board drive profile parameters, see "Translation of Signal Numbers" on page 107.

Signal Type	Signal No, Inverter		Offset	PNU No, PROFIdrive (Signal No. + Offset)	Acyclic Data Exchange	Cyclic Data Exchange
	Hexadecimal	Decimal				
Parameter	0h...54Fh	0 ... 1359d	5096d	5096d ... 6455d	Yes	No
Monitor Data	000h ... 3FFh	0d ... 1023d	9192d	9192d ... 10215d	Yes	Yes
Option Board Drive Profile Parameters	400h ... 411h	1024d ... 1041d	13288d	14312d ... 14329d	Yes	Yes/no ¹
	412h, 415h ... 41Ch ²	1042d,	13288d ²	14330d,	Yes	No
		1045d ... 1052d		14333d ... 14340d		
			15336d ²	16378d,	Yes	Yes
		413h ... 414h	1043d ... 1044d	13288d	14331d ... 14332d	Yes
	41Dh ... 431h	1053d ... 1073d	13288d	14341d ... 14361d	Yes	Yes/no ¹

¹ Some of these parameters can be mapped for cyclic data exchange, see "Translation of Signal Numbers" on page 107.

² These parameters can either be accessed (as acyclic data) as an array, with offset 13288d, or can each entry in the array be mapped as a separate parameter with offset 15336d (as acyclic and/or cyclic data).

Note: The scaling of the parameter values are different if you use the parameter unit or the option board web pages, for further information, see "Parameter Data" on page 81.

9.2 Inverter parameters (Acyclic Data Exchange)

Inverter parameters are available only via acyclic communication. They **cannot** be used in cyclic data exchange, for example it is **not** possible to map them as parameters for telegram 102. The offset used for inverter parameters is 5096, i.e. inverter parameter no. 1 (maximum frequency) shall be addressed as PNU 5097. An example of reading/writing inverter parameters is shown in "Reading a parameter (Sequence 1)" on page 30.

All of the inverter parameters are unsigned 16bit integers, with the exception of the following:

Parameter	PNU	Description	Data type
7	5103	Acceleration time	Unsigned 32 bit integer
8	5104	Deceleration time	
16	5112	Jog acceleration/deceleration time	
44	5140	Second acceleration/deceleration time	
110	5206	Third acceleration/deceleration time	
111	5207	Third deceleration time	
264	5360	Power-failure deceleration time 1	
265	5361	Power-failure deceleration time 2	
791	5887	Acceleration time in low-speed range	
792	5888	Deceleration time in low-speed range	
All other	-	All inverter parameters NOT listed in this table	Unsigned 16bit integer

9.3 Monitor Data (Acyclic and Cyclic Data Exchange)

This chapter contains a table of monitor data available via both cyclic and acyclic data exchange. The values are available as 16 and 32 bit integers. To calculate the actual monitor data value, the returned integer should be multiplied by the unit specified for that parameter. For example if PNU 9193 (output frequency) is requested and a value of 500 is returned, this means that the output frequency is equal to 5 Hz (500×0.01 Hz).

PNU No	Internal No	Description	Unit	Type	Access type
16 bit					
9193	1	Output frequency	0.01Hz	unsigned	R
9194	2	Output current	0.01A/0.1A	unsigned	R
9195	3	Output voltage	0.1V	unsigned	R
9197	5	Frequency setting value	0.01Hz	unsigned	R
9198	6	Motor speed	1 rpm	unsigned	R
9199	7	Motor torque	0.1%	unsigned	R
9200	8	Converter output voltage	0.1V	unsigned	R
9201	9	Regenerative brake duty	0.1%	unsigned	R
9202	10	Electric thermal relay function	0.1%	unsigned	R
9203	11	Output current peak value	0.01A/0.1A	unsigned	R
9204	12	Converter output voltage peak value	0.1V	unsigned	R
9205	13	Input power	0.01/ 0.1kWh	unsigned	R
9206	14	Output power	0.01/ 0.1kWh	unsigned	R
9207	15	Input terminal status *1	-	-	R
9208	16	Output terminal status *2	-	-	R

PNU No	Internal No	Description	Unit	Type	Access type
16 bit					
9209	17	Load meter	0.1%	unsigned	R
9210	18	Motor excitation current	0.01A/0.1A	unsigned	R
9211	19	Position pulse	1	unsigned	R/W
9212	20	Cumulative energization time	1h	unsigned	R
9214	22	Orientation status	1	unsigned	R
9215	23	Actual operation time	1h	unsigned	R
9216	24	Motor load factor	0.1%	unsigned	R
9217	25	Cumulative power	1kWh	unsigned	R
9224	32	Torque order	0.1%	unsigned	R
9225	33	Torque current order	0.1%	unsigned	R
9226	34	Motor output	0.1kW	unsigned	R
9227	35	Feedback pulse	1	unsigned	R
9238	46	Motor temperature			R
9242	50	Power saving effect	-	unsigned	R
9243	51	Cumulative saving power	-	unsigned	R
9244	52	PID set point	0.1%	unsigned	R/W
9245	53	PID measured value	0.1%	unsigned	R/W
9246	54	PID deviation	0.1%	unsigned	R/W
9250	58	Option input terminal status1 *3	-	-	R
9251	59	Option input terminal status2 *3	-	-	R
9252	60	Option output terminal status *4	-	-	R
9253	61	Motor thermal load factor	0.1%	unsigned	R
9254	62	Transistor thermal load factor	0.1%	unsigned	R
9256	64	PTC thermistor resistance	ohm	unsigned	R
9257	65	Output power			R
9192		(with regenerative display)			
9258	66	Cumulative regenerative power			R
9260	68	2nd PID set point	0.1%	unsigned	R/W
9261	69	2nd PID measured value	0.1%	unsigned	R/W
9262	70	2nd PID deviation	0.1%	unsigned	R/W
9272	80	Integrated power on time			R
9273	81	Running time			R
9274	82	Saving energy monitor			R
9276 - 9283	84 - 91	Fault code (1) - (8)	-	-	R
9441	249	Run command *5	-	-	R/W
32 bit					
9705	513	Output frequency	0.01Hz	signed	R
9707	515	Setting frequency	0.01Hz	signed	R
9709	517	Motor rotation	0.1rpm	signed	R
9711	519	Load meter	0.1%	signed	R
9713	521	Positioning pulse	1	signed	R/W
9715	523	Watt-hour meter(1 kWh step)	1kWh	unsigned	R
9717	525	Watt-hour meter(0.1/0.01kWh step)	0.1/ 0.01kWh	unsigned	R
9719	527	Position error	1	signed	R

***1 Input terminal status details (ex. A800)**

b15														b0	
-	-	-	-	CS	RES	STOP	MRS	JOG	RH	RM	RL	RT	AU	STR	STF

This data indicates status of main unit input terminal.
The number of terminal and names depends on main unit specification.

***2 Output terminal status details (ex. A800)**

b15														b0	
-	-	-	-	-	-	-	-	SO	ABC2	ABC1	FU	OL	IPF	SU	RUN

This data indicates status of main unit output terminal.
The number of terminal and names depends on main unit specification.

***3 Option input terminal status1,2 (ex. A800 and FR-A8AX)**

Option input terminal status1

b15														b0	
X15	X14	X13	X12	X11	X10	X9	X8	X7	X6	X5	X4	X3	X2	X1	X0

Option input terminal status2

b15														b0	
-	-	-	-	-	-	-	-	-	-	-	-	-	-	-	DY

This data indicates status of FR-A8AX terminal.

***4 Option output terminal status (ex. A800 and A8AY/A8AR)**

b15														b0	
-	-	-	-	-	-	RA3	RA2	RA1	Y6	Y5	Y4	Y3	Y2	Y1	DY

This data indicates status of FR-A8AY(Y0-Y6), FR-A8AR(RA1-RA3) terminal.

***5 Run command (ex. A800 and A8AY/A8AR)**

Users can specify the terminal function using this data.

b15														b0	
-	-	-	-	RES	STOP	CS	JOG	MRS	RT	RH	RM	RL	-	-	AU

These bits function is depending on VFD parameter setting.

9.4 Drive Profile Parameters (Acyclic Data Exchange)

Inverter parameters are, when possible, mapped to PROFIdrive parameters. The remaining parameters can be accessed as vendor specific parameters.

It is recommended not to use the standard PROFIdrive parameters as vendor specific parameters.

9.4.1 PROFIdrive Parameters

The following parameters are implemented in the option board:

Parameter	Definition	R/W	Data Type	Value/Description
P915	Selection switch Setpoint telegram	R	Array [n] Unsigned16	Holds the current configuration of the Setpoint telegram.
P916	Selection switch Actual value telegram	R	Array [n] Unsigned16	Holds the current configuration of the Actual value telegram.
P922	Telegram Selection	R	Unsigned 16	Default value: Standard telegram 1. Reflects the latest accepted configuration data from the master.
P923	List of all parameters for signals	R	Array[60000] Unsigned16	All parameters that are possible to map to process data (i.e. is defined as PROFIdrive signals) are listed here; subindex = signal number. If a parameter connected to the specific signal is possible to map, the PNU number is returned. If the parameter is not possible to map, 0 is returned.
P924	Status word bit Pulses Enabled	R	Array[2] Unsigned16	Subindex 0: 2 (Signal number for ZSW1) Subindex 1: 15 (Bit position)
P930	Operating mode	R/W	Unsigned16	0001h: Speed control mode 8000h: Torque control mode 8001h: Vendor specific mode Read from the application during initialization.
P944	Fault message counter	R	Unsigned16	Incremented by one each time the fault buffer (P947) changes.
P947	Fault numbers	R	Array[8] Unsigned16	Subindex 0: Active fault situation (if the drive is in Faulted state). Subindex 1-7: Fault history, where subindex 1 holds the most recent fixed fault situation. Fault number is the corresponding PROFIdrive fault class.
P950	Scaling of fault buffer	R	Array[2] Unsigned16	Subindex 0: 8 Subindex 1: 1 Defines the number of fault situations (subindex 0) and the number of fault messages (subindex 1) for each situation that the fault buffer can hold.
P951	Fault number list	R	Array[255] Unsigned16	Holds descriptive text for each fault that is supported by the option board. Each subindex corresponds to the event code number, which means that the accessible subindices are limited. The fault description is accessed as an additional text array.

Parameter	Definition	R/W	Data Type	Value/Description
P964	Device identification	R	Array[5] Unsigned16	Manufacturer ID: 010Ch (HMS) Drive Unit Type: 0 Version (software) xxyy (decimal) Firmware date, year yyyy (decimal) Firmware date, day/month ddm (decimal)
P965	Profile number	R	OctetString 2	Byte 0: 3 (PROFIdrive profile) Byte 1: 41 (Version 4.1)
P967	STW1	R	V2	Last control word received from the controller.
P968	ZSW	R	V2	Current status word from the drive.
P972	Drive reset	R/W	Unsigned16	1: Power-on reset 2: Prepare power-on reset
P980	List of parameters	R	Array[n] Unsigned16	Parameter numbers of all existing parameters are saved in the subindices (profile parameters and regular drive parameters). The array is assigned in increasing sequence and consecutively. The end of the list of defined parameters is marked by a subindex with the value 0.
P61000	Name of station	R	Octetstring 240	The station name of the device.
P61001	IP address	R	Octetstring 4	Current IP address
P61002	MAC address	R	Octetstring 6	The MAC address
P61003	Gateway	R	Octetstring4	Current gateway address
P61004	Subnet mask	R	Octetstring4	Current subnet mask

9.4.2 Setpoint- and Actual Value (P915/P916)

P915 and P916 reflect the configuration of the PROFINET telegrams that are used for process data. The parameters are read only and consist of arrays, where the number of elements corresponds to the number of words in the IO DATA. Each element holds the PNU (Parameter Number) of the parameter mapped to that particular IO DATA word.

The parameters reflect the latest accepted parameterization data.

9.4.3 Signal List (P923)

The signal list is not saved. It is created at the time of request only for those elements (subindices) that are requested. The possibility to map vendor specific parameters is examined by asking for the Descriptor attribute of the specific parameter. It is not possible to map other PROFIdrive standard parameters than P967 and P968 (Control and Status words).

9.4.4 Drive Reset (P972)

The PROFINET master can send a reset request to the application by writing to this parameter. If the request is rejected an error is returned.

Error Code	Description
0	Illegal parameter number (Drive reset not supported).
1	Request cannot be executed due to operation status.
7	Request cannot be executed due to operation status.

9.5 General State Diagram

This general state diagram shows how the inverter behaves based on Control Word 1 (STW1). For detailed state diagrams for various modes, please consult ProfiDrive technical specification manual.

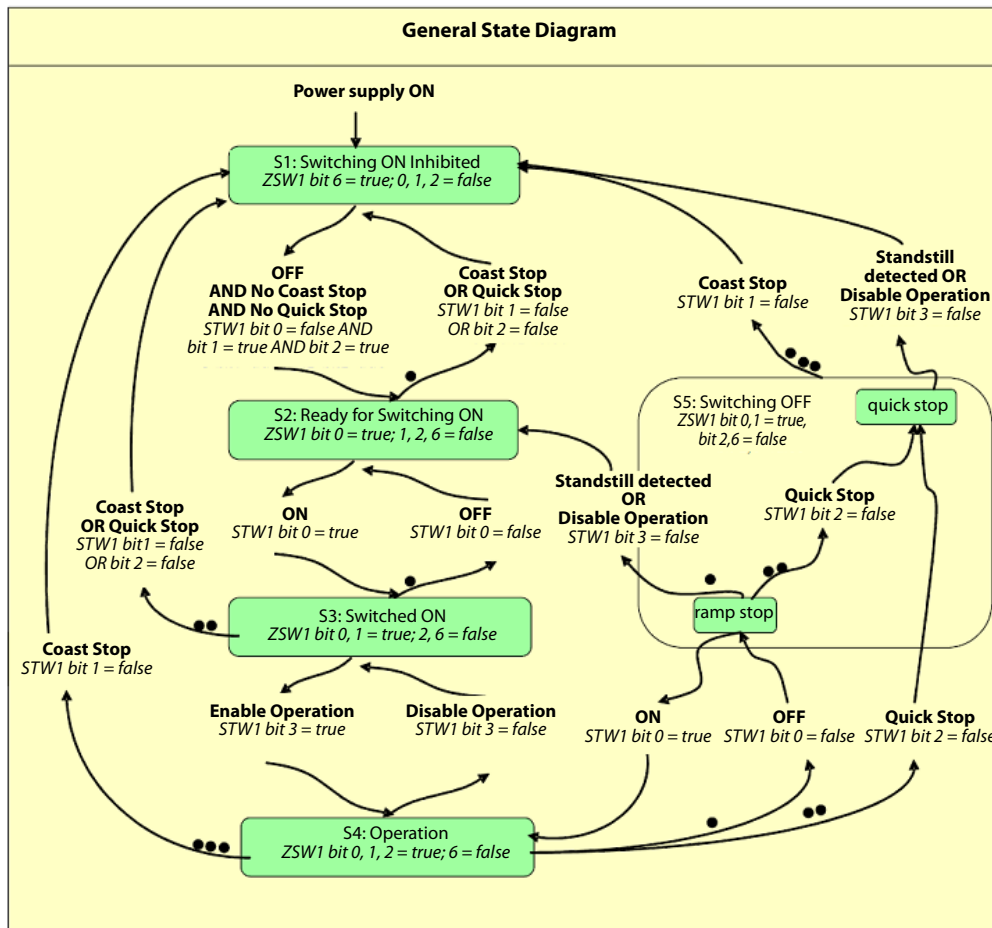

9.6 Process Data (Cyclic Data Exchange)

9.6.1 General

Drive control is per default performed through the cyclic data exchange channel. DriveControl, Drive-Status, Setpoint and Actual Values are sent as IO DATA telegrams on PROFINET. These telegrams are transformed and mapped to the inverter parameters by the option board.

The Process Data map is based entirely on the requirements of PROFIdrive and the end user by means of User Parameterization Data. The active process data is mapped in the configuration tool, where PROFIdrive profile specific signals are specified using signal numbers 1-99 and vendor specific signals are specified using signal numbers 1001... 59999.

Note: The parameter numbers are different in the web pages than in the PROFINET configuration.

9.6.2 IO Device Structure

The only submodule carrying cyclic process data, is the Telegram Data submodule. Each IO DATA channel is assigned a signal, which in turn is mapped to an inverter parameter/monitor data.

9.6.3 Signals

Each IO DATA channel is assigned a signal which is mapped to an inverter parameter. Thus PROFIdrive parameters that are to be exchanged as IO DATA (i.e. Process Data) must be assigned a unique signal number.

Signal numbers 1...99 are reserved for standard PROFIdrive signals, while signals 1001 ... 59999 are used for vendor specific signals.

The table below shows the implementation of the PROFIdrive signal list.

Signal	Abbreviation	PROFIdrive Parameter	Inverter Parameter
1	STW1	Control word 1 (P967)	DriveControl
2	ZSW1	Status word 1 (P968)	DriveStatus
-	-	-	(not assigned)
5	NSOLL_A	Speed setpoint A	SetpointSpeed
6	NIST_A	Speed actual value A	ActualSpeed
-	-	-	(not assigned)
1001...59999	-	Vendor specific	Mapped to Process Data (if possible)

Below is a brief explanation of the format of the used signals. For a detailed explanation, including control and status words specific to various operation modes, please consult ProfiDrive specification manual.

Control Word STW1

Bit	Contents
0	ON
1	No Coast Stop
2	No Quick Stop
3	Enable Operation
4	Enable Ramp Generator
5	Unfreeze Ramp Generator
6	Enable Setpoint
7	Fault Acknowledge
8	Jog 1 ON (not used)
9	Jog 2 ON (not used)
10	Control By PLC
11-15	-

Status Word ZSW1

Bit	Contents
0	Ready To Switch ON
1	Ready To Operate
2	Operation Enabled
3	Fault Present
4	Coast Stop Not Activated
5	Quick Stop Not Activated
6	Switching On Inhibited
7	Warning Present
8	Speed Error Within Tolerance
9	Control Requested
10-14	-
15	Pulses Enabled

Speed setpoint A (NSOLL_A)

The output frequency set by NSOLL_A is calculated relative to the rated frequency parameter (inverter parameter no. 3).

$$f = \frac{NSOLL_A}{0x4000} \times f_r$$

f : output frequency [Hz]

f_r : motor rated frequency [Hz]

Speed actual value A (NIST_A)

Speed actual value A is calculated in the same way as NSOLL_A.

9.6.4 Telegram Types

The Option Board supports PROFIdrive Standard Telegram 1. If additional parameters are to be mapped to process data, one of the additional product-specific telegrams (100-103) must be used, depending on the size of the data in question.

Telegram	Description	Size (words)
1	Standard Telegram 1	2
100	Telegram 100 (Torque control)	2
101	Telegram 101 (Position control)	10
102	Telegram 102 (Custom)	18
103	Telegram 103 (Custom)	32

The user specifies which telegram to use when configuring the option board. Which telegram type is used, can be read using PROFIdrive parameter P922

Note: Only one telegram module can be used at a time.

Setpoint Telegram

Setpoint telegrams are used for data from the master to the inverter. Depending on control mode, the contents of the telegram may differ, see table below for configuration.

Telegram	IO DATA (PROFIdrive)		Read Process Data (Inverter)	
	Word	Signal	Octet	Process data Parameter
Speed Control (SC) Torque Control (TC) Position Control (PC)	IO DATA 1	1 (STW1)	0...1	DriveControl (0402h)
Speed Control (SC) Torque Control (TC) Position Control (PC)	IO DATA 2	5 (NSOLL_A)	2...3	SetPoint Speed (0405h)
		14349		TargetTorque (0425h)
		9441		Run command (00F9h)
Position Control (PC)	IO DATA 3	9713	4...7	PositionReference (0209h...020Ah)
Position Control (PC)	IO DATA 4			
Position Control (PC)	IO DATA 5	5 (NSOLL_A)	8...9	SetPointSpeed (0405h)
Position Control (PC)	IO DATA 6	16383	10...13	AccelerationDeltaTime (0417h...0418h)
Position Control (PC)	IO DATA 7			
Position Control (PC)	IO DATA 8	16387	14...17	DecelerationDelta Time (014Bh...041Ch)
Position Control (PC)	IO DATA 9			

Actual Value Telegram

Actual value telegrams are used for data from the inverter to the master. Depending on control mode, the contents of the telegram may differ, see table below for configuration.

Telegram	IO DATA (PROFIdrive)		Write Process Data (Inverter)	
	Word	Signal	Octet	Process data Parameter
Speed Control (SC) Torque Control (TC) Position Control (PC)	IO DATA 1	2 (ZSW1)	0...1	DriveStatus (0403h...0404h)
Speed Control (SC) Torque Control (TC) Position Control (PC)	IO DATA 2	6 (NIST_A)	2...3	ActualSpeed (0407h)
		14350		ActualTorque (0426h)
		9208		Output terminal (0010h)
Position Control (PC)	IO DATA 3	9713	4...7	ActualPosition (0209h...020Ah)
Position Control (PC)	IO DATA 4			
Position Control (PC)	IO DATA 5	6 (NIST_A)	8...9	ActualSpeed (0407h)
Position Control (PC)	IO DATA 6	14250	10...11	ActualTorque (0426h)
Position Control (PC)	IO DATA 7			
Position Control (PC)	IO DATA 8	(9719)	12...15	PositionError (020Fh...0210h)
Position Control (PC)	IO DATA 9			

9.7 Acyclic Data Exchange

This subchapter describes some of the basic sequences used in acyclic communication. All available sequences are described in the ProfiDrive Specification manual (chapter 6.2.3.6 Telegram sequences for Parameter Access).

Acyclic communication is available via the ProfiDRIVE API (0x3a00), slot no. 1, sub-slot no. 1, index 47.

The data flow for acyclic communication always consists of writing of the parameter request, and reading the parameter response. The parameter response read may fail, if the data requested is not yet ready. The option card should be asked for a response again, until it is ready. This is presented on the figure below:

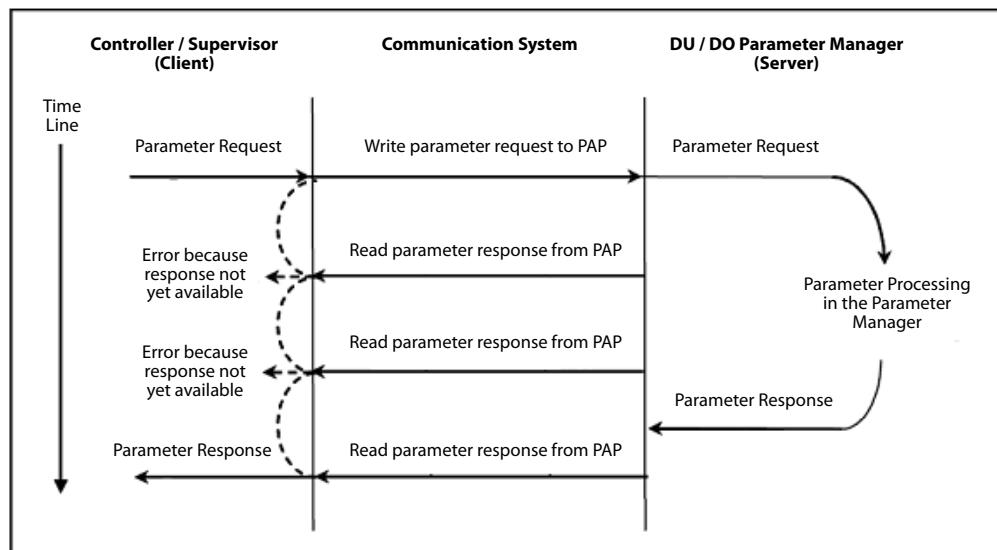

9.7.1 Explanation of fields used in requests

This table explains the fields used in various sequences. Words sent in requests should have their most significant byte transmitted first (Big endian encoding). This is also the format in which incoming words will be transmitted.

Field	Data Type	Values	Comment
Request reference	Unsigned8	0x01 – 0xFF	
Request ID	Unsigned8	0x01 Request parameter 0x02 Change parameter	
Response ID	Unsigned8	0x01 Request parameter (+) 0x02 Change parameter (+) 0x81 Request parameter (-) 0x82 Change parameter (-)	
Axis / DO-ID	Unsigned8	0x01	
No. of Parameters	Unsigned8	0x01 – 0x27 Quantity	
Attribute	Unsigned8	0x10 Value 0x20 Description 0x30 Text	
No. of elements	Unsigned8	0x01 – 0xEA Quantity	
Parameter number	Unsigned16	0x0001 – 0xFFFF	
Subindex	Unsigned16	0x0001 – 0xFFFF	
Format	Unsigned8	0x01 – 0x36 Data types 0x40 – 0x44 Data types	See data format type table
No. of values	Unsigned8	0x00 – 0xEA Quantity	
Error number	Unsigned16	0x0000 – 0x00FF Error numbers	See error table

9.7.2 Data format type table

Data type	Value
BOOLEAN	0x01
INTEGER8	0x02
INTEGER16	0x03
INTEGER32	0x04
UINTEGER8	0x05
UINTEGER16	0x06
UINTEGER32	0x07
VISIBLESTRING	0x09
OCTETSTRING	0x0a
ZERO	0x40
ERROR	0x44
N2	0x71
N4	0x72
V2	0x73

9.7.3 Error table

Error description	Value
IMPERMISSIBLE_PARAMETER_NUMBER	0x00
PARAMETER_VALUE_CANNOT_BE_CHANGED	0x01
LOW_OR_HIGH_LIMIT_EXCEEDED	0x02
FAULTY_SUBINDEX	0x03
NO_ARRAY	0x04
INCORRECT_DATA_TYPE	0x05
SETTING_NOT_PERMITTED	0x06
DESCRIPTION_ELEMENT_CANNOT_BE_CHANGED	0x07
NO_DESCRIPTION_DATA_AVAILABLE	0x09
NO_OPERATION_PRIORITY	0x0b
NO_TEXT_ARRAY_AVAILABLE	0x0f
REQUEST_CANNOT_BE_EXECUTED_BECAUSE_OF_OPERATING_STATE	0x11
VALUE_IMPERMISSIBLE	0x14
RESPONSE_TOO_LONG	0x15
PARAMETER_ADDRESS_IMPERMISSIBLE	0x16
ILLEGAL_FORMAT	0x17
NUMBER_OF_VALUES_ARE_NOT_CONSISTENT	0x18
AXIS_DO_NONEXISTENT	0x19
PARAMETER_TEXT_ELEMENT_CANNOT_BE_CHANGED	0x20

9.7.4 Sequence 1: Request parameter value, single

Byte no.	Field
0	Request ID
1	Request reference
2	No. of parameters
3	DO-ID
4	No. of elements
5	Attribute value
6-7	Parameter number
8-9	Subindex (irrelevant for non-arrays)

9.7.5 Sequence 1: Parameter response positive

Byte no.	Field
0	Request ID
1	Request reference
2	No. of parameters
3	DO-ID
4	No. of values
5	Format
6-7	Parameter value
8-9	Parameter value (only for 32 bit data)

9.7.6 Sequence 1: Parameter response negative

Byte no.	Field
0	Request ID
1	Request reference
2	No. of parameters
3	DO-ID
4	No. of values
5	Format
6-7	Error value

9.7.7 Sequence 2: Change parameter value

Byte no.	Field
0	Request ID
1	Request reference
2	No. of parameters
3	DO-ID
4	No. of elements
5	Attribute value
6-7	Parameter number
8-9	Subindex (irrelevant for non-arrays)
10	No. of values
11	Format
12-13	Set value

9.7.8 Sequence 2: Parameter response positive

Byte no.	Field
0	Request ID
1	Request reference
2	No. of parameters
3	DO-ID

9.7.9 Sequence 2: Parameter response negative

Byte no.	Field
0	Request ID
1	Request reference
2	No. of parameters
3	DO-ID
4	No. of values
5	Format
6-7	Error value

9.7.10 Sequence 3: Request parameter value, several array elements

Byte no.	Field
0	Request ID
1	Request reference
2	No. of parameters
3	DO-ID
4	No. of elements (n)
5	Attribute value
6-7	Parameter number
8-9	Subindex

9.7.11 Sequence 3: Parameter response positive

Byte no.	Field
0	Request ID
1	Request reference
2	No. of parameters
3	DO-ID
4	No. of values
5	Format
6-7	Parameter value 1
8-9	Parameter value 2
...	...
(4+2n) – (5+2n)	Parameter value n

9.7.12 Sequence 3: Parameter response negative

Byte no.	Field
0	Request ID
1	Request reference
2	No. of parameters
3	DO-ID
4	No. of values
5	Format
6-7	Error value

10. Diagnostics

Conversion of diagnostic fault codes

Inverter Fault Code	Inverter Fault Name	Inverter Description	PROFIdrive Fault	PROFIdrive Fault Code
10h	E.OC1	OC During Acc	Motor Overload	08
11h	E.OC2	Steady spd OC	Motor Overload	08
12h	E.OC3	OC During Dec	Motor Overload	08
20h	E.OV1	OV During Acc	DC Link Overvoltage	04
21h	E.OV2	Steady spd OV	DC Link Overvoltage	04
22h	E.OV3	OV During Dec	DC Link Overvoltage	04
30h	E.THT	Inv. Ovrload	Overtemperature Electronic Device	06
31h	E.THM	Motor Ovrload	Motor Overload	08
40h	E.FIN	H/Sink O/Temp	Overtemperature Electronic Device	06
50h	E.IPF	Inst. Pwr. Loss	Mains Supply	02
52h	E.ILF	Input phase loss	Mains Supply	02
60h	E.OLT	Stall Prev STP	Motor Overload	08
70h	E.BE	Br. Cct. Fault	Brake Resistor	14
80h	E.GF	Ground Fault	Earth/Ground Fault	07
81h	E.LF	Output phase loss	Power Electronics	05
90h	E.OHT	OH Fault	Motor Overload	08
91h	E.PTC	PTC Activated	External	16
A0h	E.OPT	Option fault	Engineering	18
A1h	E.OP1	Option1 fault	Internal Communication	12
A2h	E.OP2	Option2 fault	Internal Communication	12
A3h	E.OP3	Option3 fault	Internal Communication	12
B0h	E.PE	Corrupt memory	Microcontroller Hardware or Software	01
B1h	E.PUE	PU Leave out	Internal Communication	12
B2h	E.RET	Retry No Over	Technology	17
B3h	E.PE2	PR Storage Alarm	Microcontroller Hardware or Software	01
C0h	E.CPU	CPU Fault	Microcontroller Hardware or Software	01
C1h	E.CTE	PU Short cct	Other	19
C2h	E.P24	24VDC short cct	Other	19
C4h	E.CDO	OC Detect level	Technology	17
C5h	E.IOH	Inrush overheat	Mains Supply	02
C6h	E.SER	VFD Comm error	Internal Communication	12
C7h	E.AIE	Analog in error	External	16
C8h	E.USB	USB Comm error	Internal Communication	12
C9h	E.SAF	Safety cct fault	Technology	17
D0h	E.OS	Overspeed	Technology	17
D1h	E.OSD	Excess spd deviation	Technology	17
D2h	E.ECT	Enc. Signal loss	Feedback	11
D3h	E.OD	Excess pos fault	Technology	17
D5h	E.MB1	Brake seq fault	Other	19
D6h	E.MB2	Brake seq fault	Other	19
D7h	E.MB3	Brake seq fault	Other	19
D8h	E.MB4	Brake seq fault	Other	19

Inverter Fault Code	Inverter Fault Name	Inverter Description	PROFIdrive Fault	PROFIdrive Fault Code
D9h	E.MB5	Brake seq fault	Other	19
DAh	E.MB6	Brake seq fault	Other	19
DBh	E.MB7	Brake seq fault	Other	19
DCh	E.EP	Enc. Phase Fault	Feedback	11
F1h	E.1	Fault 1 (opt slot 1)	Internal Communication	12
F2h	E.2	Fault 2 (opt slot 2)	Internal Communication	12
F3h	E.3	Fault 3 (opt slot 3)	Internal Communication	12
F5h	E.5	Fault 5	Microcontroller Hardware or Software	01
F6h	E.6	Fault 6	Microcontroller Hardware or Software	01
F7h	E.7	Fault 7	Microcontroller Hardware or Software	01
FBh	E.11	Fault 11	Technology	17
FDh	E.13	Fault 13	Power Electronics	05
51h	E.UVT	Under Voltage	Mains Supply	02

A. Translation of Signal Numbers

Signal numbers used in the inverter do not directly translate to signal numbers (PNUs) used on PROFINET. An offset is added to avoid ambiguous numbering on PROFINET, where parameters and monitor data have different PNU numbers. Every signal number corresponds to 16 bits. A 32-bit parameter e.g., occupies two numbers, but is addressed by the lower number only.

Name	Signal No, Inverter		Offset (decimal)	PNU No, PROFIdrive (Signal No. + Offset)	Acyclic Data Exchange	Cyclic Data Exchange
	Hexadecimal	Decimal				
DriveControlMaskWrite	400	1024	13288	14312	Yes	Yes
DriveControl	402	1026	13288	14314	Yes	Yes
DriveStatus	403	1027	13288	14315	Yes	Yes
SetpointSpeed	405	1029	13288	14317	Yes	Yes
CommandSpeed	406	1030	13288	14318	Yes	Yes
ActualSpeed	407	1031	13288	14319	Yes	Yes
SpeedScaleNumerator	408	1032	13288	14320	Yes	No
SpeedScaleDenominator	40A	1034	13288	1	Yes	No
RatedSpeed	40C	1036	13288	14324	Yes	No
PoleCount	40D	1037	13288	14325	Yes	No
RatedCurrent	40E	1038	13288	14326	Yes	No
RatedVoltage	410	1040	13288	14328	Yes	No
MotorType	411	1041	13288	14329	Yes	No
DriveMode ²			13288	14330	Yes	No
			15336	16378	Yes	Yes
SupportedModes	413	1043	13288	14331	Yes	No
AccelerationDeltaSpeed ²			13288	14333	Yes	No
			15336	16381	Yes	Yes
AccelerationDeltaTime ²			13288	1	Yes	No
			15336	16383	Yes	Yes
DecelerationDeltaSpeed ²			13288	14337	Yes	No
			15336	16385	Yes	Yes
DecelerationDeltaTime ²	41B	1051	13288	1	Yes	No
			15336	16387	Yes	Yes
QuickDecelerationDeltaSpeed	41D	1053	13288	14341	Yes	No
QuickDecelerationDeltaTime	41F	1055	13288	1	Yes	No
MaxSpeed	421	1057	13288	14345	Yes	No
MinSpeed	423	1059	13288	14347	Yes	No
TargetTorque	425	1061	13288	14349	Yes	Yes
ActualTorque	426	1062	13288	14350	Yes	Yes
TorqueSlope	427	1063	13288	14351	Yes	No
TorqueProfileType	429	1065	13288	14353	Yes	No
RatedTorque	42A	1066	13288	14354	Yes	No
TorqueScaleNumerator	42C	1068	13288	14356	Yes	No
TorqueScaleDenominator	42E	1070	13288	1	Yes	No
DisableOptionCode	430	1072	13288	14360	Yes	No
ShutdownOptionCode	431	1073	13288	14361	Yes	No

¹ On the network, this inverter parameter is presented as subindex 1 of the preceding parameter.

² These parameters can either be accessed (as acyclic data) as an array, with offset 13288d, or can each entry in the array be mapped as a separate parameter with offset 15336d (as acyclic and/or cyclic data).

B. Troubleshooting

When a fault occurs where the inverter trips itself and the A8NPRT_2P PROFINET Option Board, check the inverter's operation panel and the LED indications on the A8NPRT_2P unit. Consult the checkpoints in the table below to identify the cause, and take appropriate countermeasures.

Operation Panel Display on the Drive	LED indications on A8NPRT_2P Option board	Possible Cause		Checkpoint/Troubleshooting
0.00E	No LED lit	The option board is not working.	The option board is not mounted properly	Check if the option board is mounted properly and in the correct option slot
			A firmware upgrade procedure was interrupted	Contact your local Mitsubishi Electric representative for further assistance
		-	Reset the inverter Perform all parameter clear to initialize all parameter settings, then powercycle the inverter	
	The option board is busy	A firmware upgrade procedure is currently running	All LEDs are off during the last 10-15 seconds of a firmware upgrade. Follow the instructions appended to the firmware upgrade package	
	LEDs lit	Please refer to "LED Indicators" on page 13.		
E.OP1	MS and NS LEDs flashing green	PROFINET master transitioned to STOP mode while "Control by PLC" (STW1 bit 10) was set, causing an inverter stop		In your application, clear bit 10 before transitioning to STOP mode or remove the cause that disconnects the data transmission between the master and the option board
	MS LED green, NS LED off	Connection was closed while "Control by PLC" (STW1 bit 10) was set, causing an inverter stop	PROFINET master or network component was powered off	Verify that the PROFINET master and all network components between master and option board are powered and fully functioning
			The network cables are not connected properly	Check if the network cables are connected properly between all nodes of the network

C. HICP (Host IP Configuration Protocol)

C.1 General

The option board supports the HICP protocol used by the Anybus IPconfig utility for changing settings, e.g. IP address, Subnet mask, and enable/disable DHCP. Anybus IPconfig can be downloaded free of charge from the HMS website, www.anybus.com. This utility may be used to access the network settings of any Anybus product connected to the network via UDP port 3250.

C.2 Operation

Upon starting the program, the network is scanned for Anybus products. The network can be re-scanned at any time by clicking 'Scan'.

To alter the network settings of the option board, double-click on its entry in the list. A window will appear, containing the settings for the option board.

Validate the new settings by clicking 'Set', or click 'Cancel' to cancel all changes.

The screenshot shows a configuration window titled "Configure: 00-00-BC-20-50-02". It is divided into two main sections: "Ethernet configuration" and "DHCP".

Ethernet configuration:

- IP address: 10 . 10 . 12 . 246
- Subnet mask: 255 . 255 . 255 . 0
- Default gateway: 0 . 0 . 0 . 0
- Primary DNS: 0 . 0 . 0 . 0
- Secondary DNS: 0 . 0 . 0 . 0
- Hostname: homer
- Password: (empty field)
- New password: (empty field)

DHCP:

- Radio buttons for "On" and "Off". "Off" is selected.
- Checkbox for "Change password" (unchecked).

At the bottom of the window are two buttons: "Set" and "Cancel".

Optionally, the configuration can be protected from unauthorized access by a password. To enter a password, click on the 'Change password' checkbox, and enter the password under 'New password'.

D. Copyright Notices

This product includes software developed by Carnegie Mellon, the Massachusetts Institute of Technology, the University of California, and RSA Data Security:

Copyright 1986 by Carnegie Mellon.

Copyright 1983,1984,1985 by the Massachusetts Institute of Technology

Copyright (c) 1988 Stephen Deering.

Copyright (c) 1982, 1985, 1986, 1992, 1993

The Regents of the University of California. All rights reserved.

This code is derived from software contributed to Berkeley by Stephen Deering of Stanford University.

Redistribution and use in source and binary forms, with or without modification, are permitted provided that the following conditions are met:

- Redistributions of source code must retain the above copyright notice, this list of conditions and the following disclaimer.
- Redistributions in binary form must reproduce the above copyright notice, this list of conditions and the following disclaimer in the documentation and/or other materials provided with the distribution.
- Neither the name of the University nor the names of its contributors may be used to endorse or promote products derived from this software without specific prior written permission.

THIS SOFTWARE IS PROVIDED BY THE REGENTS AND CONTRIBUTORS ``AS IS'' AND ANY EXPRESS OR IMPLIED WARRANTIES, INCLUDING, BUT NOT LIMITED TO, THE IMPLIED WARRANTIES OF MERCHANTABILITY AND FITNESS FOR A PARTICULAR PURPOSE ARE DISCLAIMED. IN NO EVENT SHALL THE REGENTS OR CONTRIBUTORS BE LIABLE FOR ANY DIRECT, INDIRECT, INCIDENTAL, SPECIAL, EXEMPLARY, OR CONSEQUENTIAL DAMAGES (INCLUDING, BUT NOT LIMITED TO, PROCUREMENT OF SUBSTITUTE GOODS OR SERVICES; LOSS OF USE, DATA, OR PROFITS; OR BUSINESS INTERRUPTION) HOWEVER CAUSED AND ON ANY THEORY OF LIABILITY, WHETHER IN CONTRACT, STRICT LIABILITY, OR TORT (INCLUDING NEGLIGENCE OR OTHERWISE) ARISING IN ANY WAY OUT OF THE USE OF THIS SOFTWARE, EVEN IF ADVISED OF THE POSSIBILITY OF SUCH DAMAGE.

Copyright (C) 1990-2, RSA Data Security, Inc. All rights reserved.

License to copy and use this software is granted provided that it is identified as the "RSA Data Security, Inc. MD4 Message-Digest Algorithm" in all material mentioning or referencing this software or this function.

License is also granted to make and use derivative works provided that such works are identified as "derived from the RSA Data Security, Inc. MD4 Message-Digest Algorithm" in all material mentioning or referencing the derived work.

RSA Data Security, Inc. makes no representations concerning either the merchantability of this software or the suitability of this software for any particular purpose. It is provided "as is" without express or implied warranty of any kind.

These notices must be retained in any copies of any part of this documentation and/or software.

Copyright (C) 1991-2, RSA Data Security, Inc. Created 1991. All rights reserved.

License to copy and use this software is granted provided that it is identified as the "RSA Data Security, Inc. MD5 Message-Digest Algorithm" in all material mentioning or referencing this software or this function.

License is also granted to make and use derivative works provided that such works are identified as "derived from the RSA Data Security, Inc. MD5 Message-Digest Algorithm" in all material mentioning or referencing the derived work.

RSA Data Security, Inc. makes no representations concerning either the merchantability of this software or the suitability of this software for any particular purpose. It is provided "as is" without express or implied warranty of any kind.

These notices must be retained in any copies of any part of this documentation and/or software.

Index

A	M
Acyclic Data Exchange 100	Monitor Data 90
C	N
Control Word STW1 97	Network Connector 12
D	O
Data Exchange 89	Option Board Parameters 72
Drive Profile Parameters 89	
Monitor Data 89	
Parameter 89	
Drive Profile Parameters 93	
Drive Reset 94	
E	P
Environment	Parameters
Specifications 8	1300 (General settings) 72
Ethernet	1301 (Ethernet Host Settings) 73
Communication Settings (Parameter 1317) ... 74	1305 - 1308 (IP Address) 73
Host Settings (Parameter 1301) 73	1309 - 1312 (Subnet Mask) 73
	1313 - 1316 (Gateway Address) 73
	1317 (Ethernet Communication Settings) 74
	Process Data 96
	PROFIdrive Parameters 93
	Profinet Controller setup 16
F	S
FTP Server 85	SIMATIC STEP7 62
G	Specifications
Gateway Address (Parameters 1313 - 1316) 73	Environment 8
General settings (Parameter 1300) 72	Speed actual value A (NIST_A) 97
General State Diagram 95	Speed setpoint A (NSOLL_A) 97
GX Works	Status Word ZSW1 97
Network Detect 39	Subnet Mask (Parameters 1309 - 1312) 73
Telegram 1 25	
Telegram 102 27	
I	T
Inverter parameters 90	Telegram Types 98
IP Address (Parameters 1305 - 1308) 73	TIA Portal
	Acyclic communication 51
	Telegram 1 40
	Telegram 102 49
L	W
LED Indicators 13	Web Server 77
Error 13	
Link (1, 2) 13	
Module status 13	
Network status 13	

