



Main

Range of product	Modicon M251
Product or component type	Logic controller
[Us] rated supply voltage	24 V DC

Complementary

Number of I/O expansion module	14 with remote I/O architecture 7 with local I/O architecture
Supply voltage limits	20.4...28.8 V
Inrush current	<= 50 A
Power consumption in W	32.6...40.4 W with max number of I/O expansion module
Memory capacity	64 MB system memory RAM 8 MB program
Data backed up	128 MB built-in flash memory for backup of user programs
Data storage equipment	<= 32 GB SD card optional
Battery type	BR2032 lithium non-rechargeable, battery life: 4 yr
Backup time	2 years at 25 °C
Execution time for 1 KInstruction	0.7 ms other instruction 0.3 ms event and periodic task
Execution time per instruction	0.022 µs
Application structure	8 event tasks 4 cyclic master tasks 3 cyclic master tasks + 1 freewheeling task 8 external event tasks
Realtime clock	With
Clock drift	<= 60 s/month at 25 °C
Integrated connection type	Ethernet port "Ethernet 2" with RJ45 connector Dual-port "Ethernet 1" with RJ45 connector Non isolated serial link "serial" with RJ45 connector; physical interface: RS232/RS485 USB port with mini B USB 2.0 connector
Supply	5 V at 200 mA serial link supply with "serial" marking
Transmission rate	480 Mbit/s for bus length of 3 m - communication protocol: USB 1.2...115.2 kbit/s (115.2 kbit/s by default) for bus length of 3 m - communication protocol: RS232 1.2...115.2 kbit/s (115.2 kbit/s by default) for bus length of 15 m - communication protocol: RS485
Communication port protocol	Non isolated serial link - Modbus protocol ; transmission frame: RTU/ASCII or So-Machine-Network with master/slave method USB port - USB protocol ; transmission frame: SoMachine-Network
Port Ethernet	"Ethernet 2" marking 10BASE-T/100BASE-TX - 1 port copper cable "Ethernet 1" marking 10BASE-T/100BASE-TX - 2 port copper cable
Web services	Web server

The information provided in this documentation contains general descriptions and/or technical characteristics of the performance of the products contained herein. This documentation is not intended as a substitute for and is not to be used for determining suitability or reliability of these products for specific user applications. It is the duty of any such user or integrator to perform the appropriate and complete risk analysis, evaluation and testing of the products with respect to the relevant specific application or use thereof. Neither Schneider Electric Industries SAS nor any of its affiliates or subsidiaries shall be responsible or liable for misuse of the information contained herein.

Communication service	<p>FDR Modbus TCP I/O Scanner and Messaging (Eth2) Ethernet/IP scanner (Eth2) Ethernet/IP target (Eth1, Eth2) Ethernet/IP originator (Eth2) DHCP server (Eth2) DHCP client (Eth1) SMS notifications Updating firmware SNMP Programming NGVL Monitoring Modbus TCP slave device Modbus TCP server Modbus TCP client IEC VAR ACCESS FTP Downloading</p>
Maximum number of connections	<p>8 SoMachine protocol 10 web server 4 FTP server 16 Ethernet/IP target 8 Modbus client 8 Modbus server</p>
Number of slave	<p>64 Modbus TCP 16 Ethernet/IP</p>
Cycle time	<p>64 ms with 64 slave(s) on Modbus TCP 10 ms with 16 slave(s) on Ethernet/IP</p>
Local signalling	<p>1 LED green for Ethernet activity (ETH2) 1 LED green for Ethernet activity (ETH1) 1 LED red for bus fault on TM4 (TM4) 1 LED green for SL 1 LED red for BAT 1 LED green for SD card access (SD) 1 LED red for I/O error (I/O) 1 LED red for module error (ERR) 1 LED green for RUN 1 LED green for PWR</p>
Electrical connection	Removable screw terminal block for power supply with pitch 5.08 mm adjustment
Insulation	<p>Between supply and ground at 500 V AC Non-insulated between supply and internal logic</p>
Marking	CE
Surge withstand	<p>0.5 kV (power lines) with differential mode protection conforming to EN/IEC 61000-4-5 1 kV (power lines) with common mode protection conforming to EN/IEC 61000-4-5 1 kV (shielded cable) with common mode protection conforming to EN/IEC 61000-4-5</p>
Mounting support	<p>Plate or panel with fixing kit Top hat type TH35-7.5 rail conforming to IEC 60715 Top hat type TH35-15 rail conforming to IEC 60715</p>
Height	90 mm
Depth	95 mm
Width	54 mm
Product weight	0.22 kg

Environment

Standards	UL 508 UL 1604 Marine specification (LR, ABS, DNV, GL) EN/IEC 61131-2 : 2007 CSA C22.2 No 213 CSA C22.2 No 142 ANSI/ISA 12-12-01
Product certifications	CSA CULus
Resistance to electrostatic discharge	4 kV (on contact) conforming to EN/IEC 61000-4-2 8 kV (in air) conforming to EN/IEC 61000-4-2
Resistance to electromagnetic fields	1 V/m (2 GHz...3 GHz) conforming to EN/IEC 61000-4-3 3 V/m (1.4 GHz...2 GHz) conforming to EN/IEC 61000-4-3 10 V/m (80 MHz...1 GHz) conforming to EN/IEC 61000-4-3
Resistance to fast transients	1 kV (serial link) conforming to EN/IEC 61000-4-4 1 kV (Ethernet line) conforming to EN/IEC 61000-4-4 2 kV (power lines) conforming to EN/IEC 61000-4-4
Resistance to conducted disturbances, induced by radio frequency fields	10 V (spot frequency (2, 3, 4, 6.2, 8.2, 12.6, 16.5, 18.8, 22, 25 MHz)) conforming to Marine specification (LR, ABS, DNV, GL) 3 V (0.1...80 MHz) conforming to Marine specification (LR, ABS, DNV, GL) 10 V (0.15...80 MHz) conforming to EN/IEC 61000-4-6
Electromagnetic emission	Radiated emissions - test level: 47 dB μ V/m QP class A (10 m) at 230 MHz...1 GHz conforming to EN/IEC 55011 Radiated emissions - test level: 40 dB μ V/m QP class A (10 m) at 30...230 MHz conforming to EN/IEC 55011 Conducted emissions - test level: 63 dB μ V/m QP (power lines) at 1.5...30 MHz conforming to EN/IEC 55011 Conducted emissions - test level: 79...63 dB μ V/m QP (power lines) at 150 kHz...1.5 MHz conforming to EN/IEC 55011 Conducted emissions - test level: 120...69 dB μ V/m QP (power lines) at 10...150 kHz conforming to EN/IEC 55011
Immunity to microbreaks	10 ms
Ambient air temperature for operation	-10...55 °C horizontal installation -10...35 °C vertical installation
Ambient air temperature for storage	-25...70 °C
Relative humidity	10...95 % without condensation in storage 10...95 % without condensation in operation
IP degree of protection	IP20 with protective cover in place
Pollution degree	2
Operating altitude	0...2000 m
Storage altitude	0...3000 m
Vibration resistance	3 gn at 8.4...150 Hz on panel mounting 3.5 mm at 5...8.4 Hz on panel mounting 3 gn at 8.4...150 Hz on symmetrical rail 3.5 mm at 5...8.4 Hz on symmetrical rail
Shock resistance	15 gn during 11 ms

Offer Sustainability

Sustainable offer status	Green Premium product
RoHS (date code: YYWW)	Compliant - since 1350 - Schneider Electric declaration of conformity
REACH	Reference not containing SVHC above the threshold
Product environmental profile	Available Download Product Environmental
Product end of life instructions	Available Download End Of Life Manual

Dimensions

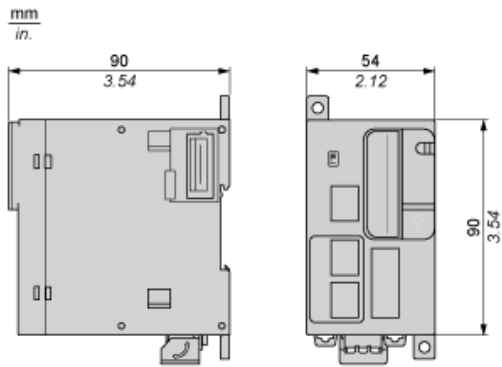

Clearance

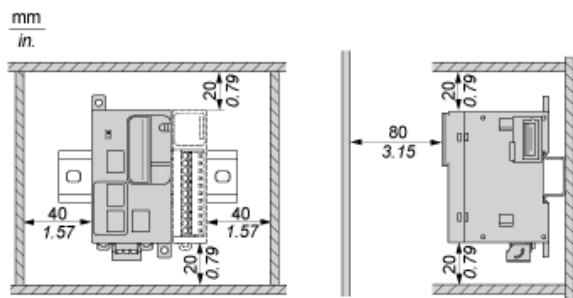

Mounting Position

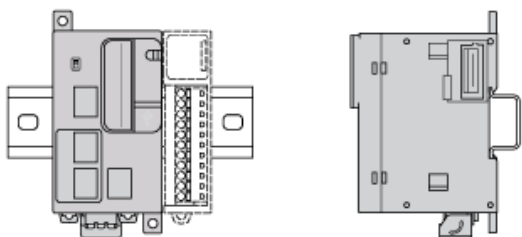

NOTE: Keep adequate spacing for proper ventilation and to maintain an ambient temperature between -10°C (14°F) and 55°C (131°F).

Acceptable Mounting

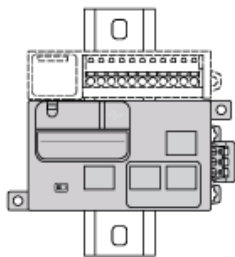

NOTE: Expansion modules must be mounted above the controller.

Incorrect Mounting

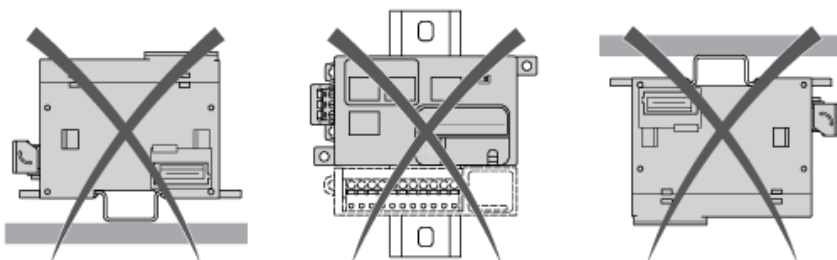

Direct Mounting on a Panel Surface

M4 x 6/8 mm
0.24/0.31 in.

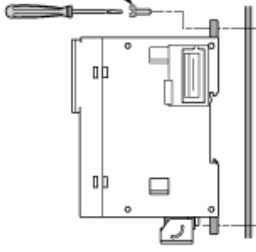

mm
in.

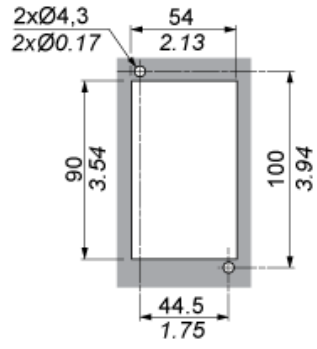

USB Connection to a PC



Ethernet Connection to a PC

