

TD-36

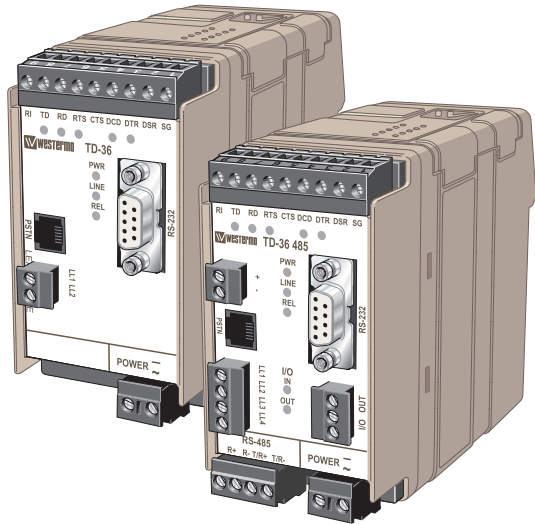

TD-36

DIN-rail Tele and Leased Line modem

TD-36 485

***DIN-rail Tele and Leased Line modem
with I/O and RS-485***



Legal information

The contents of this document are provided "as is". Except as required by applicable law, no warranties of any kind, either express or implied, including, but not limited to, the implied warranties of merchantability and fitness for a particular purpose, are made in relation to the accuracy and reliability or contents of this document. Westermo reserves the right to revise this document or withdraw it at any time without prior notice.

Under no circumstances shall Westermo be responsible for any loss of data or income or any special, incidental, and consequential or indirect damages howsoever caused.

More information about Westermo can be found at the following Internet address:

<http://www.westermo.com>

Safety



Before installation:

This modem is for restricted access area use only.

Read this manual completely and gather all information on the unit. Make sure that you understand it fully. Check that your application does not exceed the safe operating specifications for this unit.

This unit should only be installed by qualified personnel.

This unit should be built-in to an apparatus cabinet, or similar, where access is restricted to service personnel only.

The power supply wiring must be sufficiently fused, and if necessary it must be possible to disconnect manually from the power supply. Ensure compliance to national installation regulations.

Maximum 20 A branch circuit protection required.

The product is intended to work with IT power system.

This unit uses convection cooling. To avoid obstructing the airflow around the unit, follow the spacing recommendations (see Cooling section).



Before mounting, using or removing this unit:

Prevent access to hazardous voltage by disconnecting the unit from power supply.

Warning! Do not open connected unit. Hazardous voltage may occur within this unit when connected to power supply or TNV circuits.

Care recommendations

Follow the care recommendations below to maintain full operation of unit and to fulfil the warranty obligations.

This unit must not be operating with removed covers or lids.

Do not attempt to disassemble the unit. There are no user serviceable parts inside.

Do not drop, knock or shake the unit, rough handling above the specification may cause damage to internal circuit boards.

Do not use harsh chemicals, cleaning solvents or strong detergents to clean the unit.

Do not paint the unit. Paint can clog the unit and prevent proper operation.

Do not expose the unit to any kind of liquids (rain, beverages, etc). The unit is not water-proof. Keep the unit within the specified humidity levels.

Do not use or store the unit in dusty, dirty areas, connectors as well as other mechanical part may be damaged.

If the unit is not working properly, contact the place of purchase, nearest Westermo distributor office or Westermo Tech support.

Maintenance

No maintenance is required, as long as the unit is used as intended within the specified conditions.

Agency approvals and standards compliance

Type	Approval / Compliance
	EN 55024, Immunity IT equipment
	EN 55022, Emission IT equipment
	EN 61000-6-1, Immunity residential environments
	EN 61000-6-2, Immunity industrial environments
	EN 61000-6-4, Emission industrial environments
	FCC part 15 Class A
	EN 50121-4, Railway signalling and telecommunications apparatus
	IEC 62236-4, Railway signalling and telecommunications apparatus
Safety	UL/IEC/EN 60950-1, IT equipment
PSTN	CS 03 Part 1, issue 9 FCC part 68, TIA-968-A ETSI TS103 021-1, ETSI TS103 021-2, ETSI TS103 021-3 AS/ACIF S002, AS/ACIF S006

According to: **TIA-968-A and CS-03 Part 1, issue 9**

This equipment complies with Part 68 of the FCC rules and the requirements adopted by the ACTA. On the left side of this equipment is a label that contains, among other information, a product identifier in the format US:AAAEQ##TXXXX. If requested, this number must be provided to the telephone company.

A plug and jack used to connect this equipment to the premises wiring and telephone network must comply with the applicable FCC Part 68 rules and requirements adopted by the ACTA. A compliant telephone cord and modular plug is provided with this product. It is designed to be connected to a compatible modular jack that is also compliant. See installation instructions for details.

Caution-to reduce the risk of fire, use only No.26 AWG or larger telecommunication cable.

The USOC jack required RJ11-C, and the REN is used to determine the number of devices that may be connected to a telephone line. Excessive RENs on a telephone line may result in the devices not ringing in response to an incoming call. In most but not all areas, the sum of RENs should not exceed five (5.0). To be certain of the number of devices that may be connected to a line, as determined by the total RENs, contact the local telephone company. For products approved after July 23, 2001, the REN for this product is part of the product identifier that has the format US:AAAEQ##TXXXX. The digits represented by ## are the REN without a decimal point (e.g., 03 is a REN of 0.3). For earlier products, the REN is separately shown on the label.

If this equipment TD-36/485 causes harm to the telephone network, the telephone company will notify you in advance that temporary discontinuance of service may be required. But if advance notice isn't practical, the telephone company will notify the customer as soon as possible. Also, you will be advised of your right to file a complaint with the FCC if you believe it is necessary.

The telephone company may make changes in its facilities, equipment, operations or procedures that could affect the operation of the equipment. If this happens the telephone company will provide advance notice in order for you to make necessary modifications to maintain uninterrupted service.

If trouble is experienced with this equipment TD-36/485, for repair or warranty information, please contact Westermo Data Communication, Inc. 11200 Westheimer, Suite 900. Houston, TX, 77042. Phone number: 713-240-0367. If the equipment is causing harm to the telephone network, the telephone company may request that you disconnect the equipment until the problem is resolved. There are no repairs the customer/user can perform inside the modem.

In the event of equipment malfunction, all repairs should be performed by our Company or an authorized agent. It is the responsibility of users requiring service to report the need for service to our Company or to one of our authorized agents. Service can be facilitated through our office at:

Westermo Data Communication Inc

11200 Westheimer Suite 900
Houston, TX, 77042
TEL: 713-240-0367

Connection to party line service is subject to state tariffs. Contact the state public utility commission, public service commission or corporation commission for information.

If your home has specially wired alarm equipment connected to the telephone line, ensure the installation of this TD-36/485 does not disable your alarm equipment. If you have questions about what will disable alarm equipment, consult your telephone company or a qualified installer.

Electrical Safety Advisory:

Parties responsible for equipment requiring AC power should consider including an advisory notice in their customer information suggesting the customer use a surge arrester. Telephone companies report that electrical surges, typically lightning transients, are very destructive to customer terminal equipment connected to AC power sources. This has been identified as a major nationwide problem.

Declaration of Conformity



Westermo Teleindustri AB

Declaration of conformity

The manufacturer Westermo Teleindustri AB
SE-640 40 Stora Sundby, Sweden

Herewith declares that the product(s)

Type of product	Model	Art no
Tele and leased line modem	TD-36 LV	3618-0110
	TD-36 AV	3618-0101
	TD-36 485 LV	3618-0010
	TD-36 485 AV	3618-0001

is in conformity with the following EC directive(s).

No	Short name
1999/5/EC	Radio and Telecommunication Terminal Equipment (R&TTE)
2011/65/EU	Restriction of the use of certain hazardous substances in electrical and electronic equipment (RoHS)

References of standards applied for this EC declaration of conformity.

No	Title	Issue
EN 61000-6-1	Electromagnetic compatibility – Immunity for residential environments	2007
EN 61000-6-2	Electromagnetic compatibility – Immunity for industrial environments	2005
EN 61000-6-4	Electromagnetic compatibility – Emission for industrial environments	2007
EN 55022	Information technology equipment - Emission	2006 +A1:2007
EN 55024	Information technology equipment - Immunity	1998 +A1:2001 +A2:2003
EN 50121-4	Railway applications - Electromagnetic compatibility Emission and immunity of the signalling and telecommunications apparatus	2006
EN 60950-1	Information technology equipment – Safety – General requirements	2006 + A11:2009 + A1:2010 + A12:2011

The last two digits of the year in which the CE marking was affixed: 13

Signature

Pierre Öberg
Technical Manager
1st Mars 2013

Postadress/Postal address
S-640 40 Stora Sundby
Sweden

Tel.
016-428000
Int+46 16428000

Telefax
016-428001
Int+46 16428001

Postgiro
52 72 79-4

Bankgiro
5671-5550

Org.nr/
Corp. identity number
556361-2604

Registered office
Eskilstuna

Type tests and environmental conditions

Electromagnetic Compatibility			
Phenomena	Test	Description	Test levels
ESD	EN 61000-4-2	Enclosure contact	± 6 kV
		Enclosure air	± 8 kV
RF field AM modulated	IEC 61000-4-3	Enclosure	20 V/m @ (80 – 2700) MHz 1 kHz sine, 80% AM
RF field 900 MHz	ENV 50204	Enclosure	20 V/m pulse modulated 200 Hz, 900 ± 5 MHz
Fast transient	EN 61000-4-4	Signal ports	± 2 kV
		Power ports	± 2 kV
Surge	EN 61000-4-5	Signal ports unbalanced	± 2 kV line to earth, ± 2 kV line to line
		Signal ports balanced	± 2 kV line to earth, ± 1 kV line to line
		Power ports	± 2 kV line to earth, ± 2 kV line to line
RF conducted	EN 61000-4-6	Signal ports	10 V 80% AM (1 kHz), 0.15 – 80 MHz
		Power ports	10 V 80% AM (1 kHz), 0.15 – 80 MHz
Voltage dips and interruption	EN 61000-4-11	AC power ports	10 & 5 000 ms, interruption 10 & 500 ms, 30% reduction 100 & 1 000 ms, 60% reduction
Mains freq. 50 Hz	EN 61000-4-16	Signal ports	100 V 50 Hz line to earth
Voltage dips and interruption	EN 61000-4-29	DC power ports	10 & 100 ms, interruption 10 ms, 30% reduction 10 ms, 60% reduction +20% above & -20% below rated voltage
Radiated emission	EN 55022	Enclosure	Class A
	FCC part 15		Class A
Conducted emission	EN 55022	AC power ports	Class B
		PSTN	Class B
	FCC part 15	AC power ports	Class B
	EN 55022	DC power ports	Class B
Dielectric strength	EN 60950	Signal port to other isolated ports	2 kVrms 50 Hz 1 min
		Power port to other isolated ports	3 kVrms 50 Hz 1 min 2 kVrms 50 Hz 1 min (@ rated power <60 V)
Environmental			
Temperature		Operating	-25 to +70°C
		Storage & Transport	-40 to +70°C
Humidity		Operating	5 to 95% relative humidity non condensing
		Storage & Transport	5 to 95% relative humidity non condensing
Altitude		Operating	2 000 m / 70 kPa
Reliability prediction (MTBF)	MIL-HDBK-217F	Operating	
Service life		Operating	10 year
Vibration	IEC 60068-2-6	Operating	7,5 mm, 5 – 8 Hz 2 g, 8 – 500 Hz
Shock	IEC 60068-2-27	Operating	15 g, 11 ms
Packaging			
Enclosure	UL 94	PC / ABS	Flammability class V-1
Dimension W x H x D			55 x 100 x 132 mm
Weight			0.36 kg
Degree of protection	IEC 529	Enclosure	IP 20
Cooling			Convection
Mounting			Horizontal on 35 mm DIN-rail

Description

The TD-36 (485) is designed to function reliably within industrial environments and in areas of high level interference.

The TD-36 (485) is a V.34 modem meaning that it can support bidirectional data rates of up to 33.6 kbit/s on the PSTN or leased line side. Fast connect ensures that leased lines can re-establish connections in the range of 5 seconds.

The modem is equipped with transient protection on the line side and a “watchdog” that monitors and automatically resets the modem in the event of a fault. These functions together with remote configuration make the modem perfect for installation at unmanned sites and prevent the need of costly service trips.

The modem also has password protection, dial-back security and caller ID answering to ensure that only authorised users can communicate with the modem and any connected equipment.

The TD-36 (485) also has a single digital input and output relay. The input and output can be used to trigger, or be triggered by a number of different user defined events. Both the digital input and output are galvanically isolated from the rest of the modem.

For ease of setup the modem is supported by the Westermo TD-tool configuration software but also has DIP switches to assist configuration. Drivers for Windows setup are also supplied.

- ⌘ Extended temperature range -25°C to $+70^{\circ}\text{C}$
- ⌘ Data rate up to 33.6 kbit/s with Fast Connect
- ⌘ Terminal rate up to 115.2 kbit/s
- ⌘ 2-wire Leased Line (also 4-wire Leased Line on TD-36 485)
- ⌘ V23 HDX with multidrop (also FDX on TD-36 485)
- ⌘ DTR and incoming data dialling
- ⌘ DIP-switch configuration
- ⌘ Watchdog
- ⌘ Secure call back and access
- ⌘ Industrial environment transient protection on all interfaces
- ⌘ Up to 11 bits
- ⌘ Tri-Galvanic isolation (interface/line/supply)
- ⌘ Caller ID presentation and answering
- ⌘ Remote configuration
- ⌘ RS-422 / RS-485 interface (only in TD-36 485)
- ⌘ Digital I/O (only in TD-36 485)
- ⌘ Dial backup for PSTN and Leased Line (only in TD-36 485)

Generic I/O

The generic I/O gives the following functionality:

1. Establishing a data connection to a predefined target number

When the input is pulsed, the modem establishes a data connection to the stored predefined number. After a time (specified in the modem) without data exchange, the connection is released by an inactivity timer.

2. Sending an SMS Message to a predefined targetnumber

When the input is pulsed, the modem will send an SMS to a predefined number. The SMS Messages can handle at least 160 characters. TAP and UCP protocols are supported.

3. Sending a Text Message to a predefined targetnumber

When the input is triggered, the modem will establish a connection to the stored modem number and transfer a predefined text message. This is not an SMS message.

4. Using the remote digital output

When the input is triggered, the modem will establish a connection to the stored number of a remote TD-36 and send out a command, that pulses the remote output according to a predefined sequence.

5. Executing an AT-Command string

Pre-programmed AT command strings stored in the modem can be executed. These can (for example) be used for switching DTE communication parameters for online and offline modes by using two entries.

6. Transparent I/O

When the input is triggered, the modem will establish a connection to the stored number of a remote TD-36 and send out a command, and after a connection is established, the I/O is bi-directional.

Digital Output

The digital output gives the following functionality:

1. Output Contact

The modem has a change over relay output (SPDT-contact). This output can be controlled by a remote modem through Transparent I/O and Output service in the Generic I/O function. The output can also be programmed to follow the local DCD or DTR signals.

2. Remotely controlled

The output can be programmed to follow a remote modem data input. A remote unit can also set/reset the output as well as transferring a sequence of “set- and resets” of the output.

3. Follow DCD/Network

The output can be programmable to follow the local DCD or DTR signal.

Digital Input

The digital input gives the following functionality:

1. Static input

A static digital level triggered input high or low triggers the Generic I/O. With a level triggered input only the first entry in the Generic I/O list can be triggered by the I/O input.

The input is triggered when the selected level has been stable for t_a ms. A new trig will not occur until the input has return to the opposite state an back again.

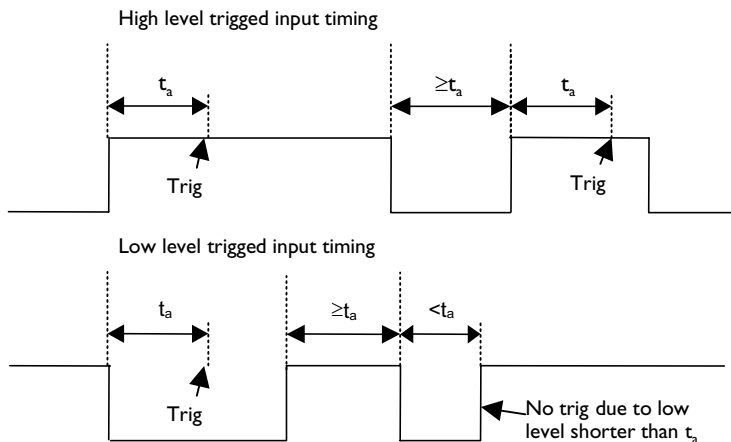

2. Pulsed Input

When input is set to edge triggered pulsed the number of pulses counted selects the entry to be triggered.

For the pulsing of an input, some timings must be kept.

The input is filtered and pulses shorter than t_a is discriminated. The time between pulses must also be kept shorter than T_p . One other restriction on T_p is that $T_p \geq 2t_a$.

When time between pulses exceeds T_p the number of pulses are accumulated and an entry selected by number of pulses counted.

The parameter t_a is also used when output pulsing is selected.

The parameters t_a and T_p are programmable from 10 ms to 2550 ms.

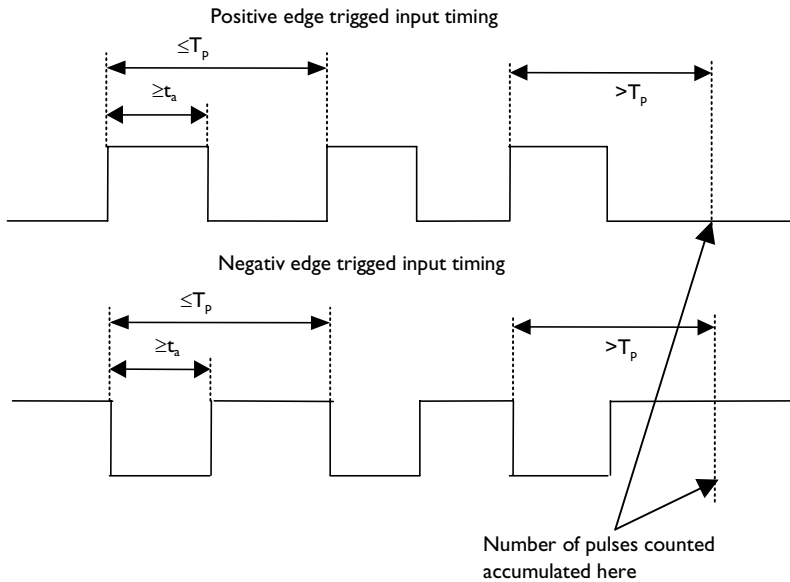

Interface specifications

Power AV	
Rated voltage	20 to 250 VDC 24 to 240 VAC
Operating voltage	18 to 300 VDC 22 to 264 VAC
Rated current	125 mA @ 18 VDC 15 mA @ 110 VDC 8 mA @ 250 VDC 120 mA @ 22 VAC 35 mA @ 95 VAC 28 mA @ 240 VAC
Rated frequency	DC: – AC: 48 – 62 Hz
Inrush current I^2t	0.45 A ² s
Startup current*	0.25 A _{peak}
Polarity	Polarity independent
Isolation to	All other ports 3 kV _{rms} 50 Hz 1 min
Connection	Detachable screw terminal
Connector size	0.2 – 2.5 mm ² (AWG 24-12)
Shielded cable	Not required

Power LV	
Rated voltage	12 to 48 VDC 12 to 27 VAC
Operating voltage	10 to 60 VDC 10 to 30 VAC 48 – 62 Hz
Rated current	150 mA @ 12 VDC 70 mA @ 24 VDC 40 mA @ 48 VDC 150 mA @ 12 VAC 70 mA @ 24 VAC
Rated frequency	DC: – AC: 48 – 62 Hz
Inrush current I^2t	0.25 A ² s
Startup current*	0.30 A _{peak}
Polarity	Polarity independent
Isolation to	All other ports 3 kV _{rms} 50 Hz 1 min
Connection	Detachable screw terminal
Connector size	0.2 – 2.5 mm ² (AWG 24-12)
Shielded cable	Not required

* External supply current capability for proper startup

Public Switched Telephone Network (PSTN)	
Electrical specification	Public Switched Telephone Network
Data rate	300 bit/s – 33.6 kbit/s
Protocol	B103, B212, V21, V22, V22B, V23C, V23 HDX, V32, V32B, V34
Protection	Installation Fault Tolerant (up to ± 60 V)
Isolation to	Power port 3 kV _{rms} 50 Hz 1 min Leased Line 2 kV _{rms} 50 Hz 1 min RS-232 2 kV _{rms} 50 Hz 1 min RS-485 2 kV _{rms} 50 Hz 1 min I/O 2 kV _{rms} 50 Hz 1 min
Connection	RJ-11C and Detachable screw terminal
Connector size	Detachable screw terminal 0.2 – 2.5 mm ² (AWG 24 – 12)
Shielded cable	Not required

Leased Line (LL)	
Electrical specification	2- or 4-wire Leased Line
Data rate	300 bit/s – 33.6 kbit/s
Protocol	B103, B212, V21, V22, V22B, V23C, V23 HDX, V32, V32B, V34
Transmission range	PSTN 30 dB
Budget	Leased Line max 40 dB
Protection	Installation Fault Tolerant (up to ± 60 V)
Isolation to	Power port 3 kV _{rms} 50 Hz 1 min Leased Line 2 kV _{rms} 50 Hz 1 min RS-232 2 kV _{rms} 50 Hz 1 min RS-485 2 kV _{rms} 50 Hz 1 min I/O 2 kV _{rms} 50 Hz 1 min
Connection	Detachable screw terminal
Connector size	0.2 – 2.5 mm ² (AWG 24 – 12)
Shielded cable	Not required

RS-422/485	
Electrical specification	EIA/TIA-485 ITU V.11 2-wire or 4-wire twisted pair
Data rate	300 bit/s – 115.2 kbit/s
Data format	7 or 8 data bits, Odd, even or none parity, 1 or 2 stop bits. 9-12 bit words
Protocol	Transparent
Retiming	Yes
Turn around time	<10 μ s (half duplex)
Transmission range	\leq 1200 m, depending on data rate and cable type (EIA RS-485)
Settings	120 Ω termination and failsafe biasing 680 Ω
Protection	Installation Fault Tolerant (up to \pm 60 V)
Isolation to	Power port 3 kV _{rms} 50 Hz 1 min PSTN Line 2 kV _{rms} 50 Hz 1 min Leased Line 2 kV _{rms} 50 Hz 1 min I/O 1.5 kV _{rms} 50 Hz 1 min
Galvanic connection to	RS-232
Connection	Detachable screw terminal
Connector size	0.2 – 2.5 mm ² (AWG 24 – 12)
Shielded cable	Not required*
Miscellaneous	Do not connect RS-232 and RS-422/485 simultaneously

RS-232	
Electrical specification	EIA/TIA-232
Data rate	300 bit/s – 115.2 kbit/s
Data format	7 or 8 data bits, Odd, even or none parity, 1 or 2 stop bits. 9-12 bit words
Protocol	Transparent
Retiming	Yes
Transmission range	Cable length \leq 15 m
Isolation to	Power port 3 kV _{rms} 50 Hz 1 min PSTN Line 2 kV _{rms} 50 Hz 1 min Leased Line 2 kV _{rms} 50 Hz 1 min I/O 1.5 kV _{rms} 50 Hz 1 min
Galvanic connection to	RS-485
Connection	9-pin D-sub female (DCE) and Detachable screw terminal (DCE)
Connector size	Detachable screw terminal 0.2 – 2.5 mm ² (AWG 24 – 12)
Shielded cable	Not required*
Miscellaneous	Do not connect RS-232 and RS-422/485 simultaneously

* Railway installation close to the rails.

For a cable located within 3 m and connected to this port, the use of shielded cable is recommended, this is to minimise the risk of interference. The cable shield should be properly connected (360°) to an earthing point within 1 m of this port. This earthing point should have a low impedance connection to the conductive enclosure of the apparatus cabinet, or similar, where the unit is built-in. This conductive enclosure should be connected to the earthing system of an installation and may be directly connected to the protective earth.

Generic I/O interface Input	
Electrical specification	Opto isolated input
Input voltage range	0 – 60 VDC
Input current	5 mA @ 60 VDC
Input inactive	U _{in} < 2.5 V
Input active	U _{in} > 5.0 V
Transmission range	Cable length ≤ 15 m
Connection	Detachable screw terminal (DCE)
Connector size	0.2 – 2.5 mm ² (AWG 24 – 12)
Isolation to	Power port 3 kV _{rms} 50 Hz 1 min PSTN line 2 kV _{rms} 50 Hz 1 min Leased Line 2 kV _{rms} 50 Hz 1 min RS-232 2 kV _{rms} 50 Hz 1 min RS-485 2 kV _{rms} 50 Hz 1 min I/O output 2 kV _{rms} 50 Hz 1 min
Shielded cable	Not required*

Generic I/O interface Relay Output	
Electrical specification	One change over contact
Switching voltage	Max 40 V AC/DC
Switching current	Max 500 mA AC/DC
Electrical endurance	5 x 10 ⁵ operations at 20 W / 20 VA Resistive load
Transmission range	Cable length ≤ 15 m
Connection	Detachable screw terminal (DCE)
Connector size	0.2 – 2.5 mm ² (AWG 24 – 12)
Isolation to	Power port 3 kV _{rms} 50 Hz 1 min PSTN line 2 kV _{rms} 50 Hz 1 min Leased Line 2 kV _{rms} 50 Hz 1 min RS-232 1.5 kV _{rms} 50 Hz 1 min RS-485 1.5 kV _{rms} 50 Hz 1 min I/O input 2 kV _{rms} 50 Hz 1 min
Shielded cable	Not required*

* Railway installation close to the rails.



For a cable located within 3 m and connected to this port, the use of shielded cable is recommended, this is to minimise the risk of interference. The cable shield should be properly connected (360°) to an earthing point within 1 m of this port. This earthing point should have a low impedance connection to the conductive enclosure of the apparatus cabinet, or similar, where the unit is built-in. This conductive enclosure should be connected to the earthing system of an installation and may be directly connected to the protective earth.

RS-232 (DCE)



Position		Direction*	Description	D-sub description
D-sub	Screw terminal			
No. 1	No. 4	Out	Data Carrier Direct (DCD)	
No. 2	No. 7	Out	Received Data (RD)	
No. 3	No. 8	In	Transmitted Data (TD)	
No. 4	No. 3	In	Data Terminal Ready (DTR)	
No. 5	No. 1	Not Connected	Signal Ground (SG)	
No. 6	No. 2	Out	Data Set Ready (DSR)	
No. 7	No. 6	In	Request To Send (RTS)	
No. 8	No. 5	Out	Clear To Send (CTS)	
No. 9	No. 9	Out	Ring Indicator (RI)	

* Direction relative to this unit.

Leased Line

Position	Direction	Description	Product marking
No. 1	In/Out	2-wire Receive/ Transmit	LL1 
No. 2	In/Out	2-wire Receive/ Transmit	LL2 

PSTN

Position				Product marking		
RJ-11C	Screw terminal**	Direction*	Description	RJ-11C	Screw terminal	
a		–	Not Connected			
b		In/Out	PSTN Transmit/ Receive Disconnects from “pin c” when the modem goes Off-Hook			
c	No. 2	In/Out	PSTN Transmit/ Receive		LL2	
d	No. 1	In/Out	PSTN Transmit/ Receive		LL1	
e		In/Out	PSTN Transmit/ Receive Disconnects from “pin c” when the modem goes Off-Hook			
f		–	Not Connected			

* Direction relative to this unit. ** The PSTN screw terminals are shared with 2-wire Leased Line.

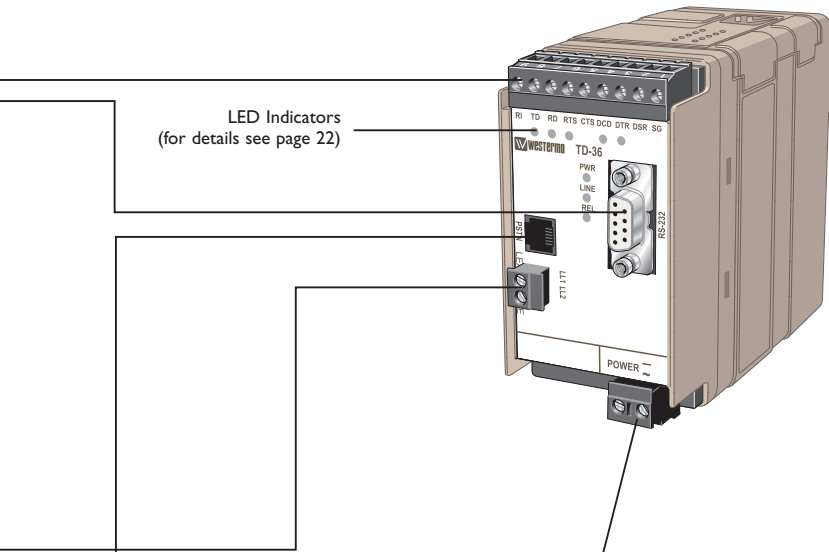

Power

Position	Direction*	Description	Product marking
No. 1	In	AC: Neutral DC: -Voltage	~
No. 2	In	AC: Line DC: +Voltage	

* Direction relative to this unit.

RS-232 (DCE)



Position		Direction*	Description	D-sub description
D-sub	Screw terminal			
No. 1	No. 4	Out	Data Carrier Direct (DCD)	
No. 2	No. 7	Out	Received Data (RD)	
No. 3	No. 8	In	Transmitted Data (TD)	
No. 4	No. 3	In	Data Terminal Ready (DTR)	
No. 5	No. 1	Not Connected	Signal Ground (SG)	
No. 6	No. 2	Out	Data Set Ready (DSR)	
No. 7	No. 6	In	Request To Send (RTS)	
No. 8	No. 5	Out	Clear To Send (CTS)	
No. 9	No. 9	Out	Ring Indicator (RI)	

* Direction relative to this unit.

Leased Line

Position	Direction*	Description	Product marking
No. 1	Out	4-wire Transmit	LL1
	In/Out	2-wire Receive/ Transmit	
No. 2	Out	4-wire Transmit	LL2
	In/Out	2-wire Receive/ Transmit	
No. 3	In	4-wire Receive	LL3
	In/Out	2-wire Receive/ Transmit at Leased Line PSTN backup	
No. 4	In	4-wire Receive	LL4
	In/Out	2-wire Receive/ Transmit at Leased Line PSTN backup	

PSTN

Position				Product marking			
RJ-11C	Screw terminal**	Direction*	Description	RJ-11C	Screw terminal		
a		–	Not Connected				
b		In/Out	PSTN Transmit/ Receive Disconnects from “pin c” when the modem goes Off-Hook				
c	No. 2	In/Out	PSTN Transmit/ Receive				LL2
d	No. 1	In/Out	PSTN Transmit/ Receive				LL1
e		In/Out	PSTN Transmit/ Receive Disconnects from “pin c” when the modem goes Off-Hook				
f		–	Not Connected				

* Direction relative to this unit. **The PSTN screw terminals are shared with 2-wire Leased Line.

LED Indicators
(for details see page 22)

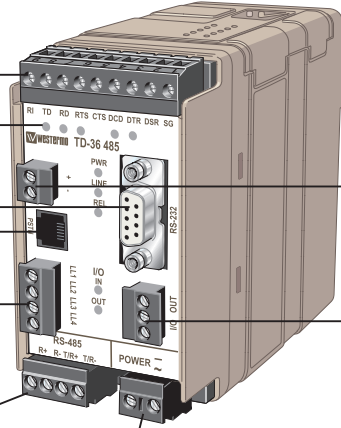

Power

Position	Direction*	Description	Product marking
No. 1	In	AC: Neutral DC: -Voltage	~
No. 2	In	AC: Line DC: +Voltage	

* Direction relative to this unit.

RS-422/485

Position	Direction*	Description	Product marking
No. 1	In	R+ (A') Receive	RS-422/485 4-wire R+
No. 2	In	R- (B') Receive	RS-422/485 4-wire R-
No. 3	Out	T+ (A) Transmit	RS-422/485 4-wire T/R+
	In/Out	T+ (A/A') Transmit/Receive	RS-485 2-wire
No. 4	Out	T- (B) Transmit	RS-422/485 4-wire T/R-
	In/Out	T+ (A/A') Transmit/Receive	RS-485 2-wire

* Direction relative to this unit

I/O Input/Relay Output

Position	Direction*	Description	Product marking	
No. 1	In	Input +	+	
No. 2	In	Input -		-
No. 1	In/Out	Normal closed contact	NC	
No. 2	In/Out	Common contact		C
No. 3	In/Out	Normal open contact		

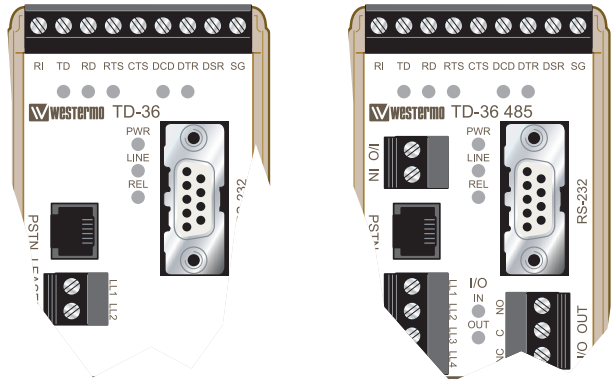

LED Indicators

LED	Status	Description
TD Transmit data	OFF	No data
	ON / FLASH	The modem receiving data on the DTE interface
RD Receive data	OFF	No data
	ON / FLASH	The modem transmitting data on the DTE interface
RTS Request to send	OFF	RTS signal is inactive
	ON	RTS signal is active
DCD Data carrier detect	OFF	DCD signal is inactive
	ON	DCD signal is active, modem has detected a carrier or the signal is set to always ON
DTR Data terminal ready	OFF	DTR signal is inactive
	ON	DTR signal is active
REL Reliable mode	OFF	Reliable mode is OFF, direct or normal mode
	ON	Reliable mode is ON
	FLASH	Reliable mode with error correction and compression
LINE	OFF	The modem is on-hook
	ON	The modem is off-hook with an established connection
	FLASH	Line backup interface in use
PWR Power	OFF	The modem has no power
	ON	The modem is up and running
Only for TD-36 485		
I/O IN	OFF	The I/O input is inactive
	ON	The I/O input is active
I/O OUT	OFF	The I/O output is inactive, C and NC connected
	ON	The I/O output is active, C and NO connected

DIP-switch settings



Before DIP-switch settings:

Prevent damage to internal electronics from electrostatic discharges (ESD) by discharging your body to a grounding point (e.g. use of wrist strap).

NOTE DIP-switch alterations are only effective after a power on.

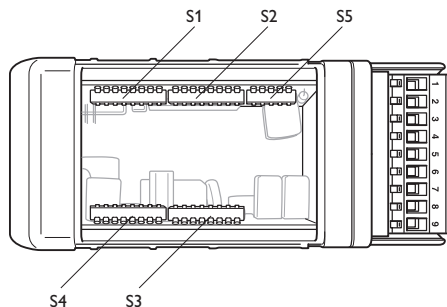

S1 DIP-switch Stored values / Auto detect



Use stored values



Auto detect*

* 300 and 600 baud not supported

S1 DIP-switch Selection of DTE speed



300 bit/s



9600 bit/s



600 bit/s



19.2 kbit/s



1200 bit/s



38.4 kbit/s



2400 bit/s



57.6 kbit/s



4800 bit/s



115.2 kbit/s

S1 DIP-switch

Selection of DTE format



7E 1S

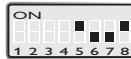

7E 2S



7O 1S

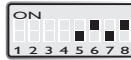

7O 2S

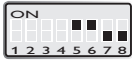

8N 1S

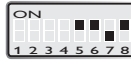

8N 2S



8E 1S

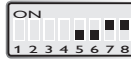

8E 2S

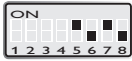

8O 1S

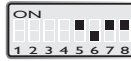

8O 2S



Direct mode 8E1 or 8O1. 8O1
in command mode



Direct mode 8E2 or 8O2. 8N2
in command mode

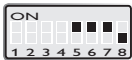

Direct mode 7E1 or 7O1. 8N1
in command mode

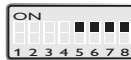

Direct mode 7E2 or 7O2. 8N2
in command mode



7N 2S

S2 DIP-switch

Leased Line Mode selection

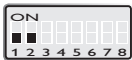

Leased Line disable, PSTN enable

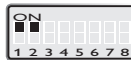

Leased Line calling



Leased Line answering

S2 DIP-switch

DTE interface selection



RS-422/485 disabled,
RS-232 enabled



RS-422/485 enabled,
RS-232 disabled

S2 DIP-switch

RS-422/485



RS-422/485, 2-wire



RS-422/485, 4-wire

S2 DIP-switch
Leased Line 2/4 wire selection



Leased Line 2-wire



Leased Line 4-wire

S2 DIP-switch
Selection PSTN backup of Leased Line



Backup of Leased Line disabled

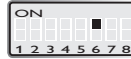

Backup of Leased Line enabled

S2 DIP-switch
Selection of answering/calling mode for PSTN backed up Leased Line



Answering

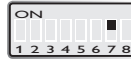

Calling

S2 DIP-switch
Remote configuration control

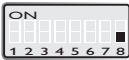

Use stored values

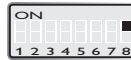

Remote configuration disabled

S3 DIP-switch
Dial abort

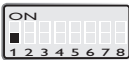

Use stored values

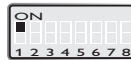

Dial abort disabled (AT&A1)

S3 DIP-switch
Blind dialing



Use stored values



Enable blind dialing (ATX3)

S3 DIP-switch
Line mode setting



Use stored values



Reliable mode enabled (AT\N2)



Buffer mode enabled (AT\N0)



Direct Mode enabled (AT\N1)

S3 DIP-switch PLC parameter setting



Use stored values



PLC settings
(ATQ1E0&C1&K0&A1)

S3 DIP-switch Flow control DTE interface

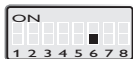

Use stored value for AT&Kn



RTS/CTS flow control enable
(AT&K3)

S3 DIP-switch Leased Line termination



Termination disabled



Termination of Receiver
in 4-wire mode



Termination of Transmitter / Receiver
in 2-wire mode and Transmitter in
4-wire mode



Termination of both Transmitter
and Receiver in 4-wire mode

S4 DIP-switch Set modem to factory default



Use stored values

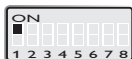

Restore factory default setting*

* Don't leave S4:1 in ON position if not intending to restore factory setting at every power on.

S4 DIP-switch DCD, DTR and DSR control



Use stored values



DCD and DSR always on, DTR
ignored (AT&C0&D0&S0)

S4 DIP-switch Data compression control



Use stored values



Data compression disabled
(AT%C0)

S4 DIP-switch Auto retrain control



Use stored values



Auto retrain disabled (AT%E0)

S4 DIP-switch

Selection of line speed and modulation



Use saved parameters defined by AT+MS



V.34, 9600



V.21 300



V.32bis 14400



V.23 1200 hdx



V.34 19200



V.22 1200



V.34 24000



V.22bis 2400



V.34 28 800

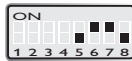

V.32bis 4800

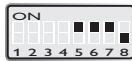

V.34 33600



V.32bis auto



Automatic line speed

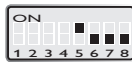

V.32bis 9600

S5 DIP-switch

RS-422/485 termination



No termination



Termination of R in 4-wire connection



Termination of both T and R in 2-wire connection



Termination of both T and R in 4-wire connection

Factory default



S1

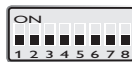

S2

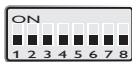

S3

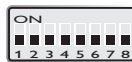

S4



S5

V.23 2- / 4-wire HDX- / FDX-leased line settings for TD-36 485

S1 DIP-switch

Selection of DTE speed



1200 bit/s

S1 DIP-switch

Selection of DTE-format



8E1, 8O1, 8O1
in command mode



8E2, 8O2, 8N2
in command mode



7E1, 7O1, 8N1, 8N1
in command mode



7E2, 7O2, 8N2, 8N2
in command mode

S2 DIP-switch

Leased line mode selection



1200 bit/s leased line /mulidrop

S2 DIP-switch

Leased line 2/4-wire selection



2-wire leased line

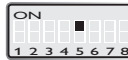

4-wire leased line

S3 DIP-switch

Carrier active using RTS or incoming data



Incoming data

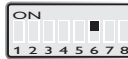

RTS controlled

S4 DIP-switch

V.23 line modulation



V.23 1200 HDX/FDX

S4 DIP-switch

Permanent carrier control



Disabled



Enabled

S3 DIP-switch

V.23 leased line termination*

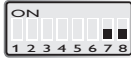

Termination disabled

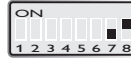

Termination of transmitter / receiver in 2-wire mode and Transmitter in 4-wire mode

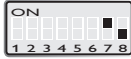

Termination of receiver in 4-wire mode

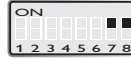

Termination of both transmitter / receiver in 4-wire mode

* The leased line should be terminated at the end points.

Termination recommendations of Leased lines and Dial-up connections

In some connections the communication line (Leased Line or PSTN) must be terminated. The table below shows the right way to activate the termination for different usages. As a standard, the receiver in multidrop systems at the end points shall be terminated.

S3 DIP-switch

Termination recommendations for TD-36 485

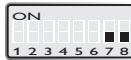

PSTN

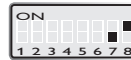

Multidrop

V23 2-wire – endunit



PSTN

Backup



Multidrop

V23 2-wire – dropunit



2-wire

Leased Line



Multidrop

V23 4-wire – endunit

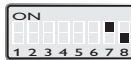

4-wire

Leased Line

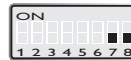

Multidrop

V23 4-wire – dropunit

RS-422/485 general advice

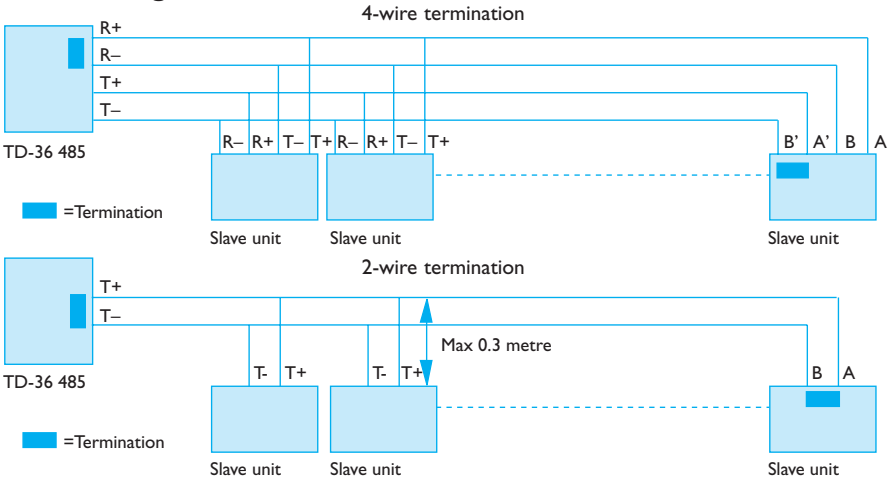

Termination recommendations

The RS-422/485 line must be terminated. In the TD-36 485, the termination is combined with fail-safe functionality. The termination is used to prevent undefined states when the bus is in tri-state condition.

- ⌘ Using 2-wire RS-485 both ends should be terminated.
- ⌘ Using 4-wire RS-485 both pairs shall be terminated at both ends.
- ⌘ Using 4-wire RS-422 it's only necessary to terminate the receivers.

RS-422/485 connection pins can be differently named. For some equipment brands the T+ corresponds to A, but other brands might use some other naming convention. If a unit does not work it can help to swap A and B.

Mounting

This unit should be mounted on 35 mm DIN-rail, which is horizontally mounted inside an apparatus cabinet, or similar. Snap on mounting, see figure.

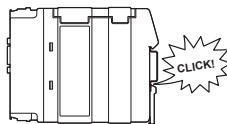
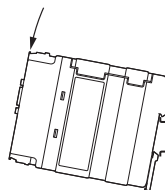

Cooling

This unit uses convection cooling. To avoid obstructing the airflow around the unit, use the following spacing rules. Minimum spacing 25 mm (1.0 inch) above /below and 10 mm (0.4 inches) left /right the unit. Spacing is recommended for the use of unit in full operating temperature range and service life.

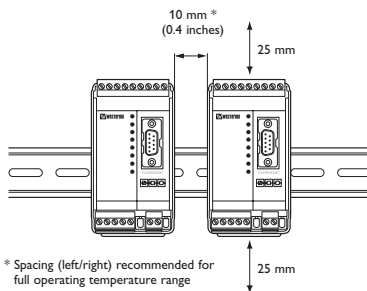

Removal

Press down the black support at the back of the unit using a screwdriver, see figure.

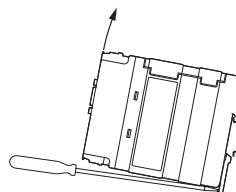
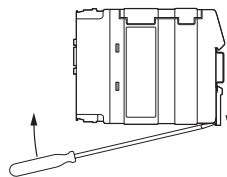

Windows configuration tool TD-Tool

The TD-Tool is a PC – application program with a graphical interface for easy configuration of the complex functions found on the enclosed CD or at the Westermo website. Please refer to TD-Tool for a complete description of the functionality of the Windows program.

AT-Commands

Please refer to the AT Commands Interface Guide found on the enclosed CD or at the Westermo website for a complete list of all available AT-commands and a detailed description of the serial AT-command interface.

Configuration

The TD-36 (485) can be configured both from the local DTE interface and remotely over the PSTN network. Whether the local or remote interface is used the configuration can be made with AT-commands or with a PC-based application configuration tool. Basic configurations can also be made with DIP switches locally. Remote configuration

The TD-36 (485) can be configured from a remote modem. To configure a TD-36 (485) any GSM, ISDN or PSTN modem can be used.

The modem used to configure is referred as the “local modem”.

Please make sure that the remote TD-36 (485) is connected to the PSTN network and is powered up.

- ⌘ Connect the local modem to it's media (ISDN, PSTN or GSM)
- ⌘ Connect the PC's com-port to the DTE interface of the local modem.
- ⌘ Connect the power supply.
- ⌘ Start a terminal emulation program (i.e. Windows Hyper-Terminal).
- ⌘ Configure the local modem data rate and word format.
- ⌘ Set up a connection to the remote TD-36 (485) to be configured by using the normal dial command: ATD<No><CR>. When connected send the remote escape sequence <++++>. The called remote TD-36 (485) will acknowledge by requesting the remote password. Enter the correct password (default: no password, just return). Next; configure the remote TD-36 (485) using AT-commands. The password for remote configuration is defined with AT*WRCP – Remote configuration password.
- ⌘ Configure the parameter on the remote TD-36 (485) from your terminal program and save the settings with AT&W.
- ⌘ Hang up the connection using the ATH command.

Application examples

☛ TD-36 connected to TD-36 with DTR signal call



Configure the units

AT&F	Set the unit to factory default
AT&W	Store default settings

Set up the connection – The dialling modem

AT&Z0=nnn	Store the number of the remote modem in the dialling TD-36
AT&S0	Set DSR signal always high (if this signal is used to trig the DTR)
AT&B1	Activates automatic DTR dialling if DTR switches from low (OFF) to high (ON)
AT&W	Save settings
Switch DTR from OFF to ON	The modem will now dial the phone number stored in the first location of the telephone number table (AT&Z0=<nnn>)

Set up the connection – The answering modem

ATA	Enter the answer command when RING comes from the network or set up AT&S0=1 to auto answer on 1 RING signal (or more than 1)
-----	--

NOTE: If no valid DTR signal can be provided by external application, the modems DSR signal can be used to trig the transmission. Connect the DSR signal via a relay, or other potential free contact, to the DTR signal. A 10 kohm pull down resistor should also be connected between the DTR and a signal that is always low e.g. the DCD.

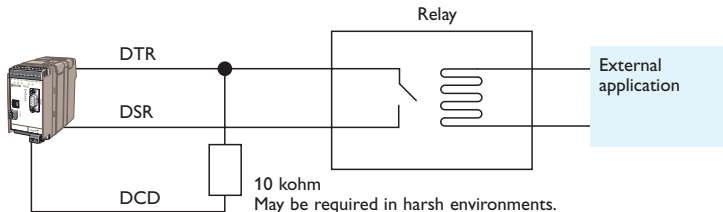

⚙️ Frequently used settings for PLC-systems



Most PLC-systems and other industrial applications where modems are used require the same changes to the standard settings.

The most commonly encountered problems concern speed, parity and control signals from the connected equipment.

Speed and parity are changed with the switches under the cover in block S1. If this action does not solve the problem the modem's answering codes and possible echoing of commands might be the source of the difficulty.

Below follows a list of commands that might resolve the problems. The commands may of course be placed on one single command line if desired.

Configure the TD-36 connected to the PLC

AT&F	Set the unit to factory default.
ATV0	Gives the answering codes in short format. (digits)
ATQ1	No result codes are sent on the RS-232/V.24 connection.
ATE0	Commands that are sent from the terminal/computer etc. are not echoed back to the RS-232/V.24 connection.
AT&C1	DCD will follow the carrier on the line.
AT&K0	No handshaking.
AT&A1	Character abort option OFF.
AT&W	Store default settings.

Note: S3:5 may be used for this purpose.

⌘ Leased Line connection using 2- or 4-wire



Leased Line connections can be set up using 2-wire (or 4-wire in TD-36 485).

When renting a 4-wire line from a telephone company one pair of cables for transmission and one pair for reception are usually provided.

The maximum transmission distance depends on the attenuation of the line.

The maximum value is theoretically 30 dBm. To have a good error rate it is recommended to keep the attenuation under 25 dB. When renting lines from a telephone company a longer transmission distance is normally possible as the signals are probably transmitted over PCM-lines, i.e.

fibres optic or other media with low attenuation.

To set the modem for leased line applications use the dip switches.

Configure the units

S2:1, 2 ON	Leased line calling
S2:2 ON	Leased line answering
S2:5 OFF	Leased line 2-wire
S1	Sets speed and parity for the RS-232 port.
S4	Decides line-speed. Must be set in direct mode applications.

To make switch setting active the power must be cycled OFF ≥ ON.

Resistance, attunation and distance for different wires

Tele Cable	Area	Resistance for double cable	Attunation	Recommended Max distance (25 dB)	Max Distance (30 dB)
∅ 0,5 mm*	≈ 0,2 mm ²	175 Ω/km	1,1 dB/km	23 km	27 km
∅ 0,6 mm*	≈ 0,3 mm ²	123 Ω/km	0,9 dB/km	28 km	33 km
∅ 0,7 mm*	≈ 0,4 mm ²	93 Ω/km	0,8 dB/km	31 km	38 km
∅ 0,8 mm	≈ 0,5 mm ²	73 Ω/km	0,7 dB/km	36 km	43 km
∅ 0,9 mm	≈ 0,64 mm ²	59 Ω/km	0,6 dB/km	42 km	50 km

* Frequently used in the local network

☺ TD-36 – Secure Call-back

The TD-36 is connected to a PLC which one want to restrict access to. The TD-36 can support access control through the Secure Callback function. In this example password and callback to a predefined number is chosen. The modem in the calling end is here chosen to be a PSTN modem, but can be any of the PSTN, ISDN or GSM modem from the Westermo product range.

The DTE serial speed between the PLC – TD-36 and TDW-33 – PC is assumed to be 9600 8N1 but can be chosen to fit the actual system requirement.

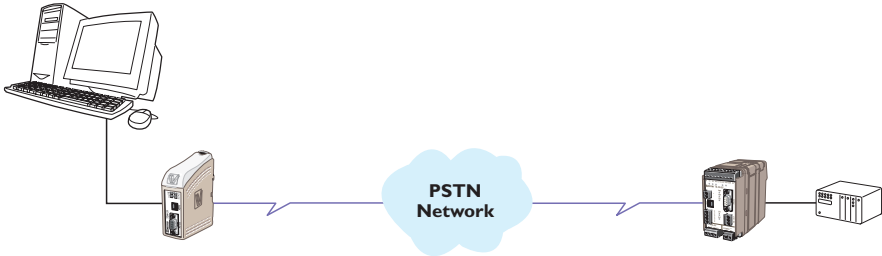

Configure the TD-36

AT&F	Set the unit to factory default
AT+IPR=9600	DTE baudrate 9600
AT+ICF=3,4	Character framing 8 data, 1 stop, parity none
ATS0=1	Auto answer after first ring
ATQ1E0&C1&K0&A1	Suitable for PLC communication
AT&W	Store default settings
AT*WCB=4	Callback enabled, Password and callback number stored in one or more positions of wcstab
AT*WCBTAB=1,"+4670428000", "n3Y9kA6otYZu8"	Define callback number 1 When password 1 is entered number +4670428000 will be called
AT*WCBTIME=10	Define delay time between hangup an callback The TD-36 will wait 10s after hangup to callback to allow the analogue modem to hangup

Configure the TDW-33

AT&F	Set the unit to factory default
AT+IPR=9600	DTE baudrate 9600
AT+ICF=3,4	Character framing 8 data, 1 stop, parity none
ATS0=1	Auto answer after first ring
AT&W	Store default settings

Set up the connection

The dialling modem TDW-33	The answering modem TD-36	Comment
ATD0705123456	TD-36 answers the call and requests to TDW-33	Dial the number to TD-36
CONNECT 9600	TD-36 verifies the password to the passwords stored and if true compare disconnects.	Operator/system at TDW-33 enters Password: n3Y9kA6otYZu8
NO CARRIER	Wait 10 s	The connection is broken and TD-36 waits the programmed 10s for TDW-33 to disconnect
	TD-36 dials +4670428000	The number programmed corresponding to the password is dialled, preferable it's the number to the TDW-33
CONNECT 9600	CONNECT 9600	Connection is established between the PC at TDW-33 and the PLC at TD-36

⌘ TD-36 – Silent answering on predefined number

The TD-36 is connected to a power meter which is remotely monitored. The TD-36 shares the PSTN line with normal telephones which is preferred not to give a ring signal when the meter is read.

The TD-36 is configured to answer calls on the Caller ID received, the valid numbers to answer is programmed into the TD-36. There exists a number of standards for sending Caller ID check which standard is used by your operator. The TD-36 supports the major implementations of Caller ID. In this example the DTMF Caller ID version is used. Note that some implementations doesn't give the possibility to make a silent answer since the Caller ID is sent between first and second ring signal.

The modem in the calling end is here chosen to be a PSTN modem, but can be any of the PSTN, ISDN or GSM modem from Westermo product range.

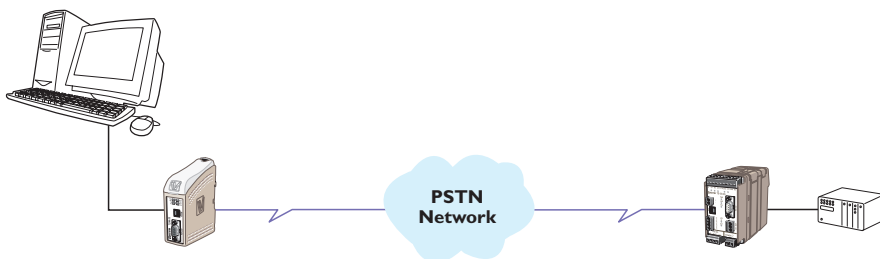

Configure the TD-36 connected to the power meter

AT&F	Set the unit to factory default
AT+IPR=9600	DTE baudrate 9600
AT+ICF=3,4	Character framing 8 data, 1 stop, parity none
ATS0=0	No auto answer on Ring signals
ATQ1E0&C1&K0&A1	Suitable for PLC communication
AT&V	Save settings
AT*WACCTAB=1,"016428000" AT*WACCTAB=2,"016480250"	Set the valid A-numbers for automatic answering
AT*WCID=3,3	Set Caller ID to A-number answer with DTMF coded numbers

☰ TD-36 485 2-wire half duplex

In this application the TD-36 485 is set to communicate with a number of units with RS-485 interface.

The communication is 2 wire half duplex at 38.4 kbit/s, 8 data, parity even and 1 stop bit.

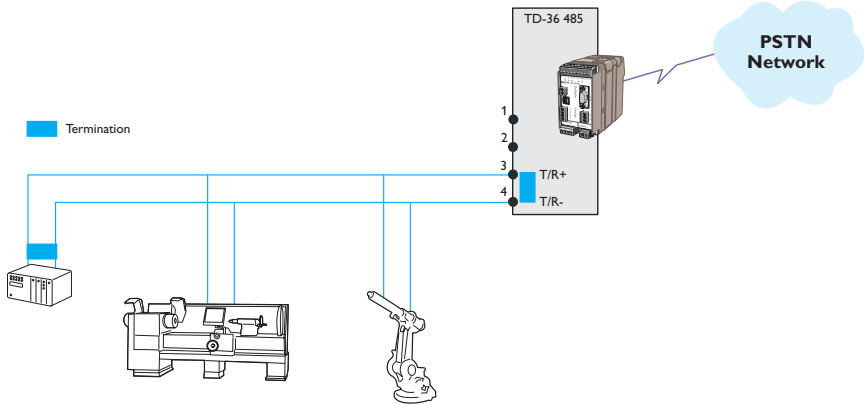

Configure the TD-36 485

AT&F	Set the unit to factory default
AT&W	Store default settings
S2:3 ON	RS-422/485 enable RS-232 disable
S2:4 OFF	Select 2-wire RS-485
S1:4 ON	38.4 kbit/s
S1:7 ON	8 data bits even parity 1 stop bit
S3:8 ON	Termination / Failsafe active

To make switch setting active the power must be cycled OFF -> ON.

⌘ Remote output and transparent mode

In this application the TD-36 485 I/O is used to send a SMS and then make an transparent I/O connection. The transparent I/O is in this example set up to an IDW-90 ISDN modem, but can be any of the Westermo remote product supporting Generic I/O (IDW-90, TD-36 485 and GDW-12).

The TD-36 485 has a alarm signal connected to it's I/O input, when this input is activated by the external alarm contact an SMS defined by Entry 1 in the entry list is sent. When the SMS is transferred Entry 2 is programmed to be triggered. Entry 2 is programmed to set up an Transparent I/O connection to an ISDN-modem IDW-90. The status of the alarm signal will be transferred to the remote IDW-90 and activate an Alarm bell. At this time the SMS should be available on the operators mobile showing the reason for the alarm. The operator can acknowledge the alarm, the acknowledge signal will now be transferred back to the originating TD-36 485 and alarm system. The alarm system will deactivate the alarm output causing the remote alarm bell to stop sounding. The Transparent I/O connection will be terminated by a programmed timeout.

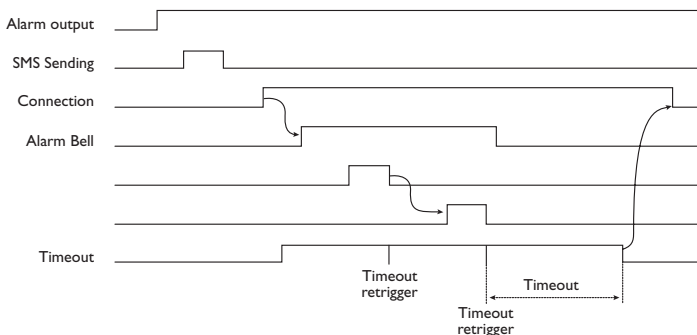
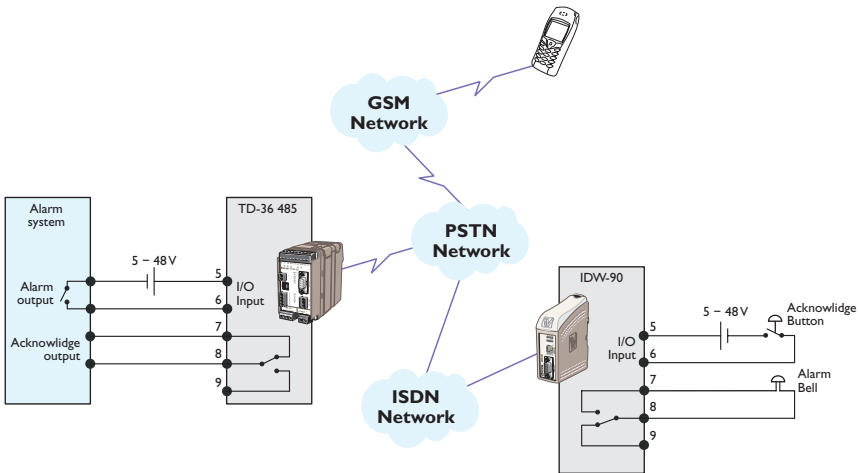

Configure the TD-36 485

AT&F	Set the unit to factory default
AT&W	Store default settings
AT*WIOF=10,50,2,3,0	Set I/O params Min pulse time = 100 ms (10) Pulse repetition = 500 ms (150) Trig type = Pulsed triggered (2) Pulse trig type = POS, pos edge (3) Output type = No output (0)
AT*WIOI=1,2,5,0,0,070428000, Temp. high server room, +4670500899,1	Define SMS message on entry 1 Entry = 1 (1) Service = SMS (2) Retry = NEXT_ALWAYS (5) Timeout = 0 Priority = 0 Data 1 = SMS receiver number (070428000) Data 2 = SMS text (Temp. high server room) Data 3 = Service center Adress (+4670500899) Data 4 = SMS protocol UDP (1)
AT*WIOI=2,7,2,60,0,+4616480250	Define Transparent I/O on entry 2 Entry = 2 (2) Service = TRANS (7) Retry = RETRY_3 (2) Timeout = 600s (60) Priority = 0 Data 1 = Phone number of the remote IDW-90 (+4616480250)

Configure the IDW-90

S3:1,3,4 OFF S3:2 ON	V.110 configured for GSM
----------------------	--------------------------

To make switch setting active the power must be cycled OFF -> ON.

Activate events – The sending modem

I/O input pulsed with one puls	SMS message transferred and transparent I/O established 
--------------------------------	---

Testing by simulating the event

AT*WIOT=1	Force sending of SMS-message at entry 1
AT*WIOT=2	Force the transparent I/O connection to be established

⌘ TD-36 485 sending text message with SMS by usage of Generic I/O

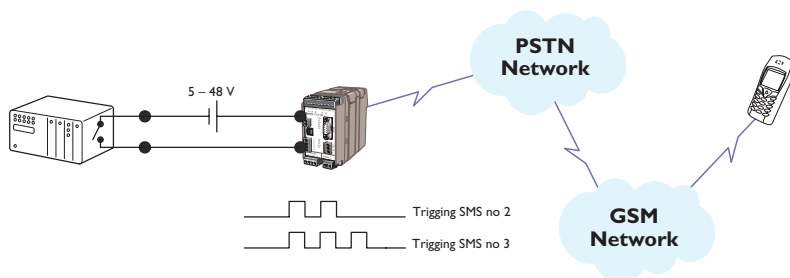

Configure a TD-36 485 to send different SMS depending on the I/O input pulse train.



Configure the TD-36 485

AT&F	Set the unit to factory default
AT&W	Store default settings
AT*WIOP=5,10,2,3,0	Set I/O params Min pulse time = 50 ms (5) Max pulse time = 100 ms (10) Trig type = Pulsed triggered (2) Pulse trig type = POS, pos edge (3) Output type = No output (0)
AT*WIOL=2,2,0,0,0,"num1","text1"," providernum1",1,"password1"	Entry = 2 (2) Service = SMS (2) Retry = NO (0) Timeout = 0 Priority = 0 Data 1 = SMS receiver number (num1) Data 2 = SMS text (text1) Data 3 = SMS provider number (providernum1) Data 4 = SMS protocol type UDP (1) Data 5 = Password if required by provider (password1)
AT*WIOL=3,2,0,0,0,"num2","text2"," providernum2",1,"password2"	Entry = 3 (3) Service = SMS (2) Retry = NO (0) Timeout = 0 Priority = 0 Data 1 = SMS receiver number (num2) Data 2 = SMS text (text2) Data 3 = SMS provider number (providernum2) Data 4 = SMS protocol UDP (1) Data 5 = Password if required by provider (password2)

Send message

I/O input pulsed with two pulses 	SMS message text1 transferred to receiver num1
I/O input pulsed with three pulses 	SMS message text2 transferred to receiver num2

Testing by simulating the event

AT*WIoT=2	Force sending of SMS-message at entry 2
AT*WIoT=3	Force sending of SMS-message at entry 3

⚡ Remote output and transparent mode

In this application the TD-36 485 I/O is used to send a SMS and then make a transparent I/O connection. The transparent I/O is in this example set up to an IDW-90 ISDN modem, but can be any of the Westermo remote products supporting Generic I/O (IDW-90 or TD-36 485).

The TD-36 485 has a alarm signal connected to it's I/O-input, when this input is activated by the external alarm contact an SMS defined by Entry 1 in the entry list is sent. When the SMS is transferred Entry 2 is programmed to be triggered. Entry 2 is programmed to set up a Transparent I/O connection to an ISDN-modem IDW-90. The status of the alarm signal will be transferred to the remote IDW-90 and activate an Alarm bell. At this time the SMS should be available on the operators mobile showing the reason for the alarm. The operator can acknowledge the alarm, the acknowledge signal will now be transferred back to the originating TD-36 485 and alarm system. The alarm system will deactivate the alarm output causing the remote alarm bell to stop sounding. The Transparent I/O connection will be terminated by a programmed timeout.

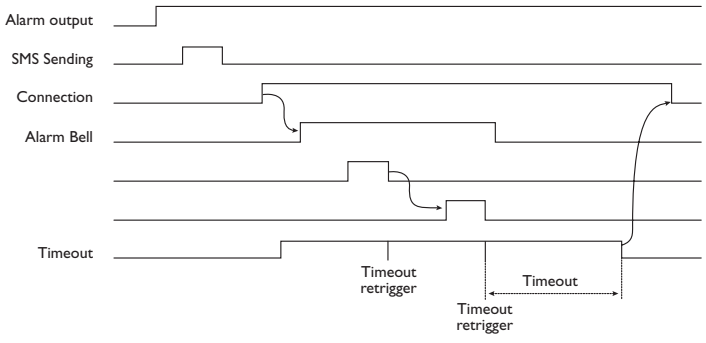
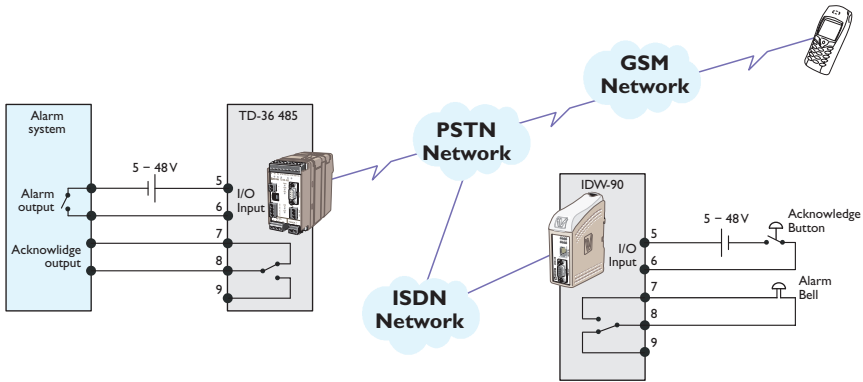

Configure the TD-36 485

AT&F	Set the unit to factory default
AT&W	Store default settings
AT*WIOP=10,50,2,3,1	Set I/O params Min pulse time = 100 ms (10) Pulse repetition = 500 ms (150) Trig type = Pulsed triggered (2) Pulse trig type = POS, pos edge (3) Output type = output enabled (1)
AT*WIOL=1,2,5,0,0,"0704 28000", "Temp. high server room", "+4670500899",1, "password"	Define SMS message on entry 1 Entry = 1 (1) Service = SMS (2)Retry = NEXT_ALWAYS(5) Timeout = 0 Priority = 0 Data 1 = SMS receiver number (070428000) Data 2 = SMS text (Temp. high server room) Data 3 = Service center Adress (+4670500899) Data 4 = SMS protocol UDP (1)
AT*WIOL=2,7,2,60,0,+4616480250	Define Transparent I/O on entry 2 Entry = 2 (2) Service = TRANS (7) Retry =RETRY_3 (2) ;Do 3 connection attempts Timeout = 600s (60) Priority = 0 Data 1 = Phone number of the remote IDW-90 (+4616480250)

Configure the IDW-90

S3:1,3,4 OFF S3:2 ON	V.110 configured for GSM
To make switch setting active the power must be cycled OFF -> ON.	

Activate events – The sending modem

IO input pulsed with one puls	SMS message transferred and transparent IO established
-------------------------------	--

Testing by simulating the event

AT*WIOT=1	Force sending of SMS-message at entry 1
AT*WIOT=2	Force the transparent I/O connection to be established.



Westermo • SE-640 40 Stora Sundby, Sweden
Tel +46 16 42 80 00 Fax +46 16 42 80 01
E-mail: info@westermo.com
www.westermo.com

Sales Units

Sweden

Westermo Data Communications
Svalgängen 1, Vallbyinstitutet, 724 81 Västerås
Tel: +46 (0) 21 548 08 00 • Fax: (0) 21 35 18 50
info.sverige@westermo.se • www.westermo.se

United Kingdom

Westermo Data Communications
Talisman Business Centre
Duncan Road, Park Gate, Southampton. SO31 7GA
Tel: +44 (0) 1489 580 585 • Fax: +44 (0) 1489 580 586
sales@westermo.co.uk • www.westermo.co.uk

Germany

Westermo Data Communications
Goethe Strasse 67
DE-68753 Waghäusel
Tel: +49 (0) 7254 95400-0 • Fax: +49 (0) 7254-95400-9
info@westermo.de • www.westermo.de

Austria

Westermo Data Communications
Tel: +43 (0) 72030 3920 • Fax: +43 (0) 2235 86131
info@westermo.at • www.westermo.at

France

Westermo Data Communications
Bat. A, 9 Chemin de Chilly
FR-91160 Champlan
Tel: +33 1 69 10 21 00 • Fax: +33 1 69 10 21 01
infos@westermo.fr • www.westermo.fr

North America

Westermo Data Communications
939 N. Plum Grove Road, Suite F,
IL 60173 Schaumburg, USA
Tel: +1 847 619 6068 • Fax: +1 847 619 66 74
info@westermo.com • www.westermo.com

Singapore

Westermo Data Communications
84 Genting Lane #07-03
Cityneon Design Centre
Singapore 349584
Tel: +65 6743 9801 • Fax: +65 6745 0670
sales@westermo.com.sg • www.westermo.com

Malaysia

Westermo Data Communications
84 Genting Lane #07-03,
Cityneon Design Centre,
Singapore 349584
Tel : +6 012 2781156 • Fax : +603 8062 7467
chinleong.teh@westermo.com.sg • www.westermo.com.sg

China

Westermo Data Communications
2F Building B
No.1618 Yishan Road
Shanghai 201103
Tel: +86 21 6145 0400 • Fax: +86 21 6145 0499
sales.cn@westermo.com • www.cn.westermo.com

Westermo Teleindustri AB have distributors in several countries, contact us for further information.