

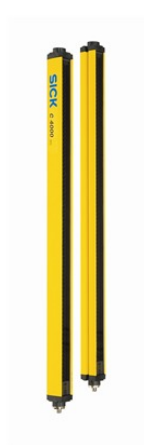

Safety light curtains C4000 Eco

C40E-0703AN310, C40S-0703AA310



receiver

Model Name > [C40E-0703AN310](#)
Part No. > [1027471](#)



sender

Model Name > [C40S-0703AA310](#)
Part No. > [1027470](#)

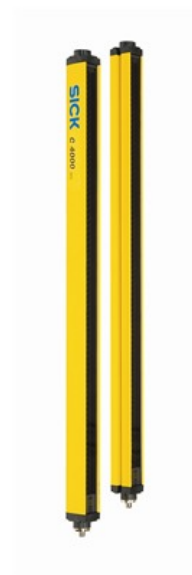

At a glance

- Type 4 (IEC 61496), PL e (EN ISO 13849)
- 7-segment display
- Impact and scratch-resistant front screen
- Extremely high electromagnetic immunity
- Standardized M12 connectivity
- Extensive range of accessories for mounting

Your benefits

- 7-segment display saves time during alignment and diagnostics
- Cost-effective: pre-assembled M12x5 cables
- Optimized cabling through innovative accessories, e.g. T-distributor with just one cable to the control cabinet
- Robust design and immunity to interference ensure maximum availability - even under tough industrial conditions
- A multitude of intelligent mounting adapters enables flexible installation

This product will be discontinued soon. Please follow the "replacement product" link for information about the successor.



Technical Data-Sender

Protective field height:	750 mm
Resolution:	30 mm
Housing length:	869 mm
Housing cross-section:	48 mm x 40 mm
Type:	Type 4 (IEC 61496)
Safety integrity level:	SIL3 (IEC 61508), SILCL3 (IEC 62061)
Category:	category 4 (EN ISO 13849)

Performance level:	PL e (EN ISO 13849)
PFHd:	1.5 * 1E-08
TM (mission time):	20 a
Supply voltage typical, from, to:	24 V DC, 19.2 V DC, 28.8 V DC
Response time without beam coding:	≤ 11 ms
Connection type:	M12 x 5, straight
Maximum connection cable cross-section:	0.25 mm ²
Wave length:	950 nm
Protection class:	III
Enclosure rating:	IP 65 (IEC 60529)
Ambient operating temperature from ... to:	0 °C ... 55 °C
Vibration resistance (checked to):	5 g (IEC 60068-2-6)
Oscillation frequency from ... to:	10 Hz ... 55 Hz
Shock resistance:	10 g, 16 ms (IEC 60068-2-29)
Weight:	1,670 g

Technical Data-Receiver

Protective field height:	750 mm
Resolution:	30 mm
Scanning range from ... to:	0 m ... 6 m
Housing length:	869 mm
Housing cross-section:	48 mm x 40 mm
Type:	Type 4 (IEC 61496)
Safety integrity level:	SIL3 (IEC 61508), SILCL3 (IEC 62061)
Category:	category 4 (EN ISO 13849)
Performance level:	PL e (EN ISO 13849)
PFHd:	1.5 * 1E-08
TM (mission time):	20 a
Supply voltage typical, from, to:	24 V DC, 19.2 V DC, 28.8 V DC
Response time without beam coding:	≤ 11 ms
Maximum switching current:	500 mA
Wave length:	950 nm
Connection type:	M12 x 5, straight
Maximum connection cable cross-section:	0.25 mm ²
Protection class:	III
Enclosure rating:	IP 65 (IEC 60529)
Ambient operating temperature from ... to:	0 °C ... 55 °C
Vibration resistance (checked to):	5 g (IEC 60068-2-6)
Oscillation frequency from ... to:	10 Hz ... 55 Hz
Shock resistance:	10 g, 16 ms (IEC 60068-2-29)
Weight:	1,700 g

Dimensional drawing

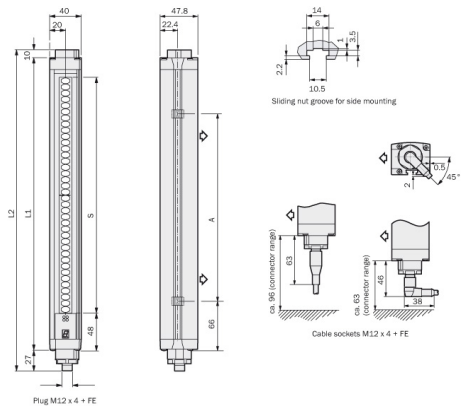

Australia

Phone +61 3 9457 0600
1800 334 802 – tollfree
E-Mail sales@sick.com.au

Belgium/Luxembourg

Phone +32 (0)2 466 55 66
E-Mail info@sick.be

Brasil

Phone +55 11 3215-4900
E-Mail sac@sick.com.br

Canada

Phone +1 905 771 14 44
E-Mail information@sick.com

Ceská Republika

Phone +420 2 57 91 18 50
E-Mail sick@sick.cz

China

Phone +86 4000 121 000
E-Mail info.china@sick.net.cn
Phone +852-2153 6300
E-Mail ghk@sick.com.hk

Danmark

Phone +45 45 82 64 00
E-Mail sick@sick.dk

Deutschland

Phone +49 211 5301-301
E-Mail kundenservice@sick.de

España

Phone +34 93 480 31 00
E-Mail info@sick.es

France

Phone +33 1 64 62 35 00
E-Mail info@sick.fr

Great Britain

Phone +44 (0)1727 831121
E-Mail info@sick.co.uk

India

Phone +91-22-4033 8333
E-Mail info@sick-india.com

Israel

Phone +972-4-6801000
E-Mail info@sick-sensors.com

Italia

Phone +39 02 27 43 41
E-Mail info@sick.it

Japan

Phone +81 (0)3 3358 1341
E-Mail support@sick.jp

Magyarország

Phone +36 1 371 2680
E-Mail office@sick.hu

Nederlands

Phone +31 (0)30 229 25 44
E-Mail info@sick.nl

Norge

Phone +47 67 81 50 00
E-Mail austefjord@sick.no

Österreich

Phone +43 (0)22 36 62 28 8-0
E-Mail office@sick.at

Polska

Phone +48 22 837 40 50
E-Mail info@sick.pl

România

Phone +40 356 171 120
E-Mail office@sick.ro

Russia

Phone +7-495-775-05-30
E-Mail info@sick.ru

Schweiz

Phone +41 41 619 29 39
E-Mail contact@sick.ch

Singapore

Phone +65 6744 3732
E-Mail admin@sicksgp.com.sg

Slovenija

Phone +386 (0)1-47 69 990
E-Mail office@sick.si

South Africa

Phone +27 11 472 3733
E-Mail info@sickautomation.co.za

South Korea

Phone +82 2 786 6321/4
E-Mail info@sickkorea.net

Suomi

Phone +358-9-25 15 800
E-Mail sick@sick.fi

Sverige

Phone +46 10 110 10 00
E-Mail info@sick.se

Taiwan

Phone +886-2-2375-6288
E-Mail sales@sick.com.tw

Türkiye

Phone +90 (216) 528 50 00
E-Mail info@sick.com.tr

United Arab Emirates

Phone +971 (0) 4 8865 878
E-Mail info@sick.ae

USA/México

Phone +1(952) 941-6780
1 800-325-7425 – tollfree
E-Mail info@sickusa.com

More representatives and agencies
at www.sick.com