



Photoelectric sensors
W250, Photoelectric retro-reflective sensor

WL250-P430



Model Name > [WL250-P430](#)
Part No. > [6010610](#)



At a glance

- Versions for 10 - 30 V DC or 12 - 240 V DC/ 24 – 240 V AC voltage supply in compact design
- Mounting bracket and P250 reflector included in delivery
- Visible red light
- Potentiometer sensitivity adjustment with indicator
- Operating mode (light/dark) selectable via control wire
- Cable or rotatable M12 connector
- UL recognized

Your benefits

- Universal AC/DC voltage variants provide high performance and increased flexibility in environments with limited space
- Mounting kit reduces installation time
- Visible red light and easy-to-read sensitivity indicator simplifies commissioning
- Simple power control for individual application adjustments via potentiometer
- Operating mode (light/dark) is selectable via a control cable to reduce the number of device variants
- Mounting compatibility - DC devices and DC/AC devices available in same design
- Polarizing filter ensures reliable detection, even with shiny targets

Note: This part is discontinued. Please see the replacement product under "Replacement Products" link. "

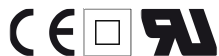

Features

Sensor/detection principle:	Photoelectric retro-reflective sensor
Dimensions (W x H x D):	20 mm x 65 mm x 43 mm
Housing design (light emission):	Rectangular
Sensing range max.:	0.01 m ... 13.5 m ¹⁾
Sensing range:::	0.01 m ... 11 m, 0.01 m ... 8 m ^{2) 3)}
Type of light:	Visible red light
Light source:	LED ⁴⁾
Light spot (distance):	400 mm (8 m)
Sensitivity adjustment:	Potentiometer, 2-turn ⁵⁾
Angle of dispersion:	2.5 °

1) 3) PL80A 2) P250 4) Average service life 100,000 h at Ta = +25 °C 5) With position indicator

Mechanics/electronics

Supply voltage:	10 V DC ... 30 V DC ¹⁾
Ripple:	≤ 5 Vpp ²⁾
Power consumption:	≤ 35 mA ³⁾
Output type:	PNP, Light/dark-switching, Selectable via L/D control wire, open collector
Output current I _{max.} :	100 mA
Response time:	≤ 0.5 ms ⁴⁾
Switching frequency:	1,000 Hz ⁵⁾
Connection type:	Connector M12, 4-pin ⁶⁾
Circuit protection:::	A, B, C, D ^{7) 8) 9) 10)}
Protection class:	II ¹¹⁾
Weight:	40 g
Polarisation filter:	✓
Housing material:	ABS
Optics material:	PMMA
Enclosure rating:	IP 67
Items supplied:	BEF-W250 mounting bracket, Reflector P250
Ambient operating temperature:	-25 °C ... 55 °C
Ambient storage temperature:	-40 °C ... 70 °C
UL File-No.:	UL No. NRNT2.E128350 & cUL No. NRNT8.E128350

¹⁾ Limit values, operation in short-circuit protected network max. 8 A ²⁾ May not exceed or fall short of V_S ³⁾ Without load ⁴⁾ Signal transit time with resistive load ⁵⁾ With light/dark ratio 1:1 ⁶⁾ 90 ° rotatable ⁷⁾ A = V_S connections reverse-polarity protected ⁸⁾ B = inputs and output reverse-polarity protected ⁹⁾ C = interference suppression ¹⁰⁾ D = outputs overcurrent and short-circuit protected ¹¹⁾ Reference voltage 50 V DC

Dimensional drawing

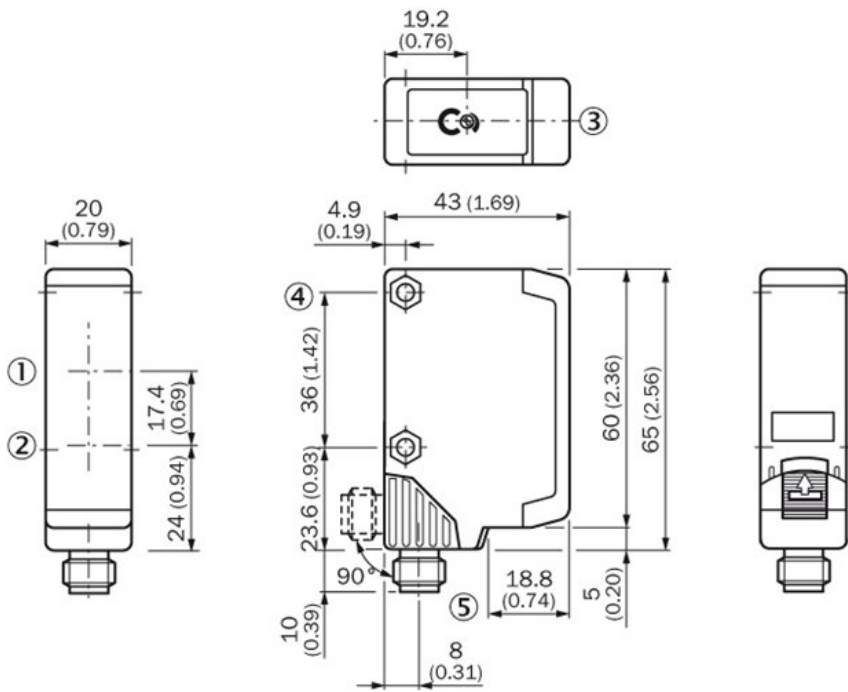

- |1| Reception axis
- |2| Transmission axis
- |3| LED reception indicator, red
- |4| Mounting hole \varnothing 4.2 mm, for M4 hexagon nut on both sides
- |5| Connection cable or M12 connector - 4-pin; connector position rotatable by 90° (V> H); V: Vertical final position; H: Horizontal final position, can be locked with

Adjustments possible

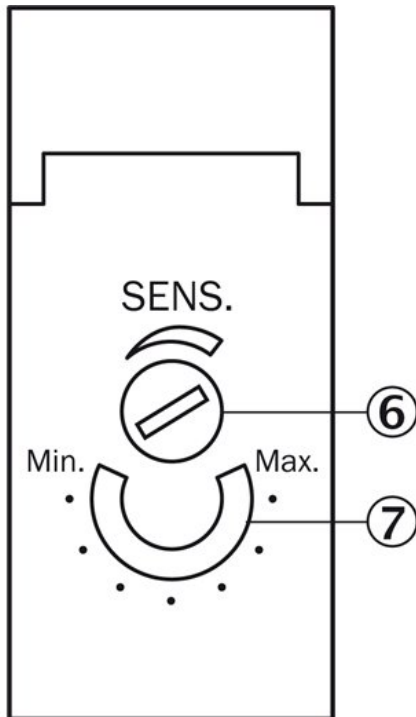

- |6| Sensitivity adjustment (2 turns) , over-turn protection
- |7| Position indicator for sensitivity setting (270°)

Connection diagram

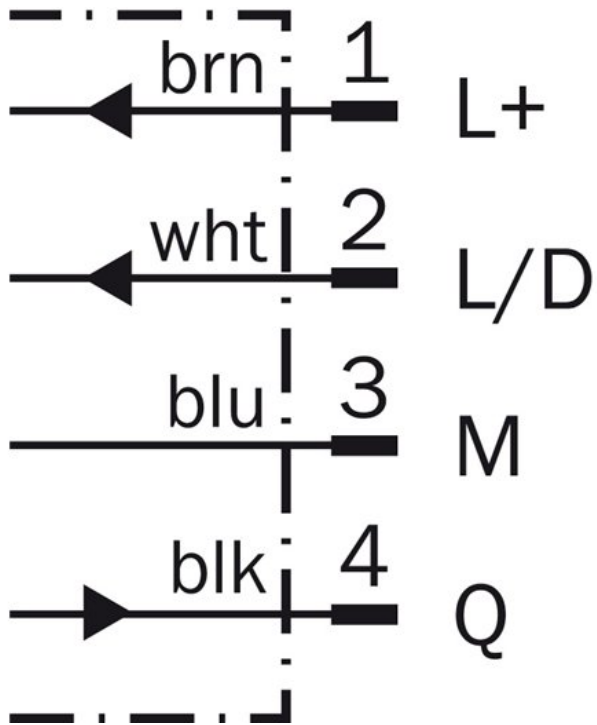

Characteristic curve

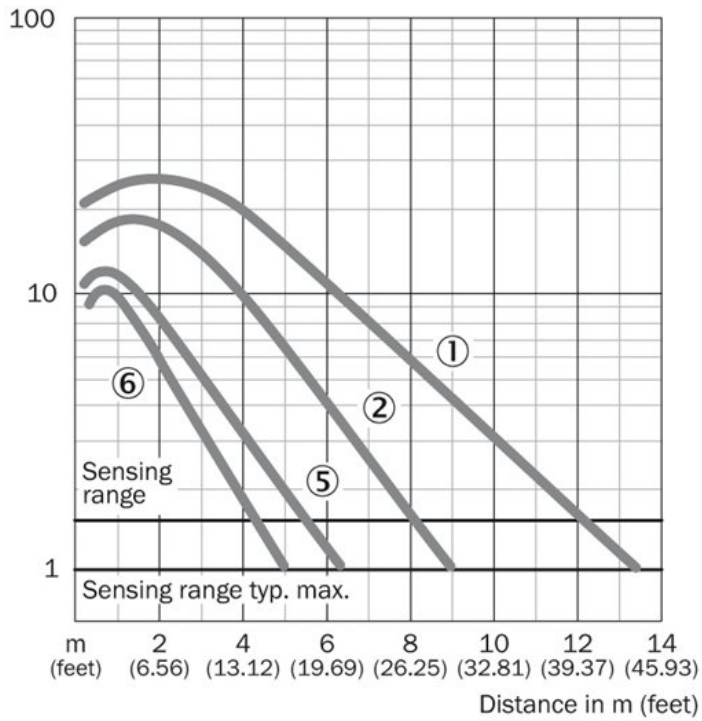

Sensing range diagram

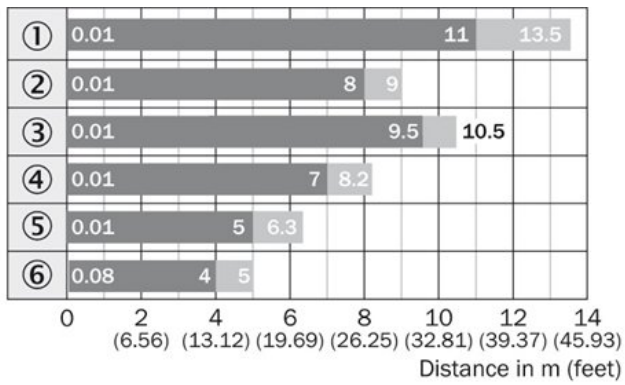

Reflector type

- ① PL80A
- ② P250
- ③ PL50A/PL40A
- ④ PL30A/PL31A
- ⑤ PL20A
- ⑥ Reflective tape
Diamond Grade

Connection type

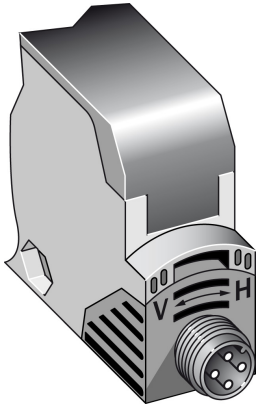

Australia

Phone +61 3 9457 0600
1800 334 802 – tollfree
E-Mail sales@sick.com.au

Belgium/Luxembourg

Phone +32 (0)2 466 55 66
E-Mail info@sick.be

Brasil

Phone +55 11 3215-4900
E-Mail sac@sick.com.br

Canada

Phone +1 905 771 14 44
E-Mail information@sick.com

Ceská Republika

Phone +420 2 57 91 18 50
E-Mail sick@sick.cz

China

Phone +86 4000 121 000
E-Mail info.china@sick.net.cn
Phone +852-2153 6300
E-Mail ghk@sick.com.hk

Danmark

Phone +45 45 82 64 00
E-Mail sick@sick.dk

Deutschland

Phone +49 211 5301-301
E-Mail kundenservice@sick.de

España

Phone +34 93 480 31 00
E-Mail info@sick.es

France

Phone +33 1 64 62 35 00
E-Mail info@sick.fr

Great Britain

Phone +44 (0)1727 831121
E-Mail info@sick.co.uk

India

Phone +91-22-4033 8333
E-Mail info@sick-india.com

Israel

Phone +972-4-6801000
E-Mail info@sick-sensors.com

Italia

Phone +39 02 27 43 41
E-Mail info@sick.it

Japan

Phone +81 (0)3 3358 1341
E-Mail support@sick.jp

Magyarország

Phone +36 1 371 2680
E-Mail office@sick.hu

Nederlands

Phone +31 (0)30 229 25 44
E-Mail info@sick.nl

Norge

Phone +47 67 81 50 00
E-Mail austefjord@sick.no

Österreich

Phone +43 (0)22 36 62 28 8-0
E-Mail office@sick.at

Polska

Phone +48 22 837 40 50
E-Mail info@sick.pl

România

Phone +40 356 171 120
E-Mail office@sick.ro

Russia

Phone +7-495-775-05-30
E-Mail info@sick.ru

Schweiz

Phone +41 41 619 29 39
E-Mail contact@sick.ch

Singapore

Phone +65 6744 3732
E-Mail admin@sicksgp.com.sg

Slovenija

Phone +386 (0)1-47 69 990
E-Mail office@sick.si

South Africa

Phone +27 11 472 3733
E-Mail info@sickautomation.co.za

South Korea

Phone +82 2 786 6321/4
E-Mail info@sickkorea.net

Suomi

Phone +358-9-25 15 800
E-Mail sick@sick.fi

Sverige

Phone +46 10 110 10 00
E-Mail info@sick.se

Taiwan

Phone +886-2-2375-6288
E-Mail sales@sick.com.tw

Türkiye

Phone +90 (216) 528 50 00
E-Mail info@sick.com.tr

United Arab Emirates

Phone +971 (0) 4 8865 878
E-Mail info@sick.ae

USA/México

Phone +1(952) 941-6780
1 800-325-7425 – tollfree
E-Mail info@sickusa.com

More representatives and agencies
at www.sick.com